

M (5 : 1)

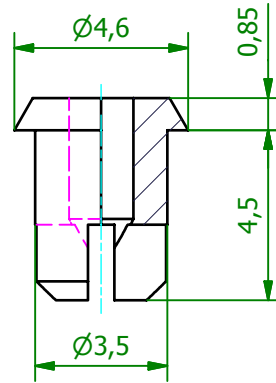

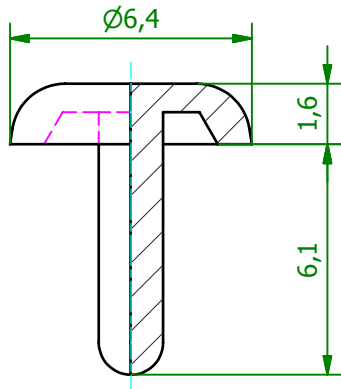

Zusammenbau

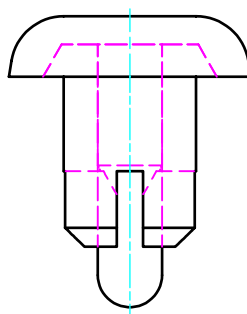
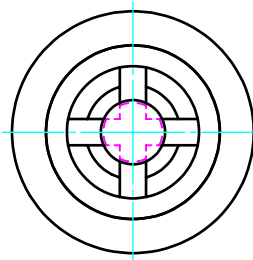

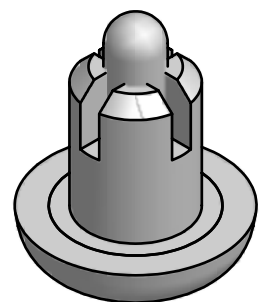
(5 : 1)

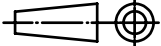
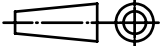

<p style="color: red;">Schutzvermerk gemäß DIN ISO 16016 beachten © Fischer Elektronik GmbH & Co. KG 2005</p>			Freimasstoleranz DIN ISO 2768m 		Oberfläche -		Kunde 77777 - Fischer Elektronik	
								
			Datum Erst. 12.08.2005 Bearb. 12.08.2005		Name Lochen Lochen		Bezeichnung / Titel Einpressniet EPN 1 Montagesatz	
			Werkstoff / Material Polysulfon		Zeichnungs-Nummer 001009249			
Z. Änderungen		Datum	Name		C001009237.ipt			Blatt 1
								Blätter 1