

Schottky Rectifier, 2 x 15 A

TO-247AC

FEATURES

- 175 °C T_J operation
- Low forward voltage drop
- High frequency operation
- High purity, high temperature epoxy encapsulation for enhanced mechanical strength and moisture resistance
- Guard ring for enhanced ruggedness and long term reliability
- Compliant to RoHS Directive 2002/95/EC
- Designed and qualified according to JEDEC-JESD47
- Halogen-free according to IEC 61249-2-21 definition (-N3 only)

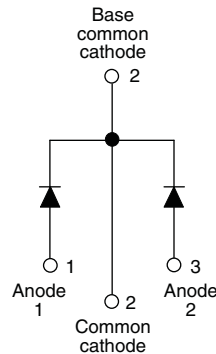

DESCRIPTION

The VS-30CPQ... center tap Schottky rectifier has been optimized for low reverse leakage at high temperature. The proprietary barrier technology allows for reliable operation up to 175 °C junction temperature. Typical applications are in switching power supplies, converters, freewheeling diodes, and reverse battery protection.

PRODUCT SUMMARY

Package	TO-247AC
$I_{F(AV)}$	2 x 15 A
V_R	80 V, 90 V, 100 V
V_F at I_F	0.67 V
I_{RM} max.	7 mA at 125 °C
T_J max.	175 °C
Diode variation	Common cathode
E_{AS}	7.5 mJ

MAJOR RATINGS AND CHARACTERISTICS

SYMBOL	CHARACTERISTICS	VALUES	UNITS
$I_{F(AV)}$	Rectangular waveform	30	A
V_{RRM}		80/100	V
I_{FSM}	$t_p = 5 \mu s$ sine	920	A
V_F	15 Apk, $T_J = 125$ °C (per leg)	0.67	V
T_J		- 55 to 175	°C

VOLTAGE RATINGS

PARAMETER	SYMBOL	VS-30CPQ080PbF	VS-30CPQ080-N3	VS-30CPQ090PbF	VS-30CPQ090-N3	VS-30CPQ100PbF	VS-30CPQ100-N3	UNITS
Maximum DC reverse voltage	V_R	80	80	90	90	100	100	V
Maximum working peak reverse voltage	V_{RWM}							

ABSOLUTE MAXIMUM RATINGS

PARAMETER	SYMBOL	TEST CONDITIONS	VALUES	UNITS
Maximum average forward current See fig. 5	$I_{F(AV)}$	50 % duty cycle at $T_C = 140$ °C, rectangular waveform	30	A
Maximum peak one cycle non-repetitive surge current per leg See fig. 7	I_{FSM}	5 μs sine or 3 μs rect. pulse	920	
		10 ms sine or 6 ms rect. pulse	240	
Non-repetitive avalanche energy per leg	E_{AS}	$T_J = 25$ °C, $I_{AS} = 0.50$ A, $L = 60$ mH	7.50	mJ
Repetitive avalanche current per leg	I_{AR}	Current decaying linearly to zero in 1 μs Frequency limited by T_J maximum $V_A = 1.5 \times V_R$ typical	0.50	A



ELECTRICAL SPECIFICATIONS					
PARAMETER	SYMBOL	TEST CONDITIONS		VALUES	UNITS
Maximum forward voltage drop per leg See fig. 1	$V_{FM}^{(1)}$	15 A	$T_J = 25\text{ }^\circ\text{C}$	0.86	V
		30 A		1.05	
		15 A	$T_J = 125\text{ }^\circ\text{C}$	0.67	
		30 A		0.81	
Maximum reverse leakage current per leg See fig. 2	$I_{RM}^{(1)}$	$T_J = 25\text{ }^\circ\text{C}$	$V_R = \text{Rated } V_R$	0.55	mA
		$T_J = 125\text{ }^\circ\text{C}$		7	
Maximum junction capacitance per leg	C_T	$V_R = 5 V_{DC}$ (test signal range 100 kHz to 1 MHz) $25\text{ }^\circ\text{C}$		500	pF
Typical series inductance per leg	L_S	Measured lead to lead 5 mm from package body		7.5	nH
Maximum voltage rate of change	dV/dt	Rated V_R		10 000	V/ μ s

Note

(1) Pulse width < 300 μ s, duty cycle < 2 %

THERMAL - MECHANICAL SPECIFICATIONS					
PARAMETER	SYMBOL	TEST CONDITIONS		VALUES	UNITS
Maximum junction and storage temperature range	T_J, T_{Stg}			- 55 to 175	$^\circ\text{C}$
Maximum thermal resistance, junction to case per leg	R_{thJC}	DC operation See fig. 4		2.20	$^\circ\text{C/W}$
Maximum thermal resistance, junction to case per package		DC operation		1.10	
Typical thermal resistance, case to heatsink	R_{thCS}	Mounting surface, smooth and greased		0.24	
Approximate weight				6	g
				0.21	oz.
Mounting torque	minimum maximum		Non-lubricated threads	6 (5)	kgf · cm (lbf · in)
				12 (10)	
Marking device		Case style TO-247AC (JEDEC)		30CPQ080	
				30CPQ090	
				30CPQ100	

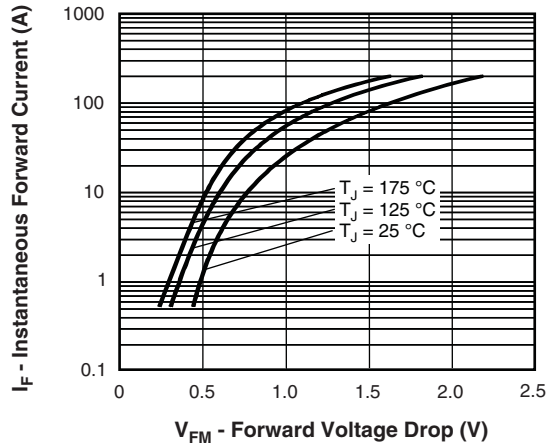

Fig. 1 - Maximum Forward Voltage Drop Characteristics (Per Leg)

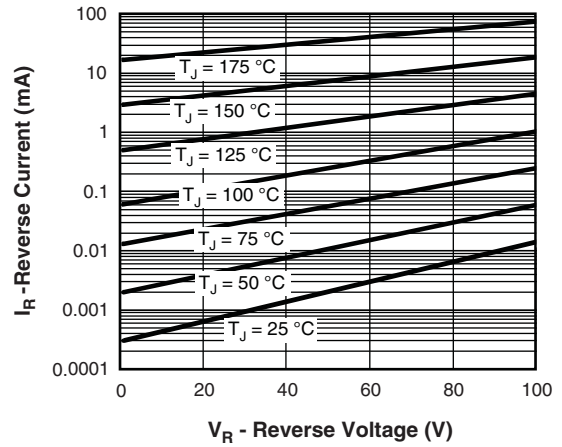

Fig. 2 - Typical Values of Reverse Current vs. Reverse Voltage (Per Leg)

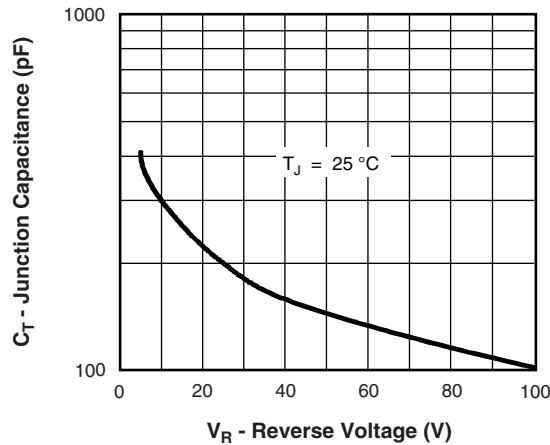

Fig. 3 - Typical Junction Capacitance vs. Reverse Voltage (Per Leg)

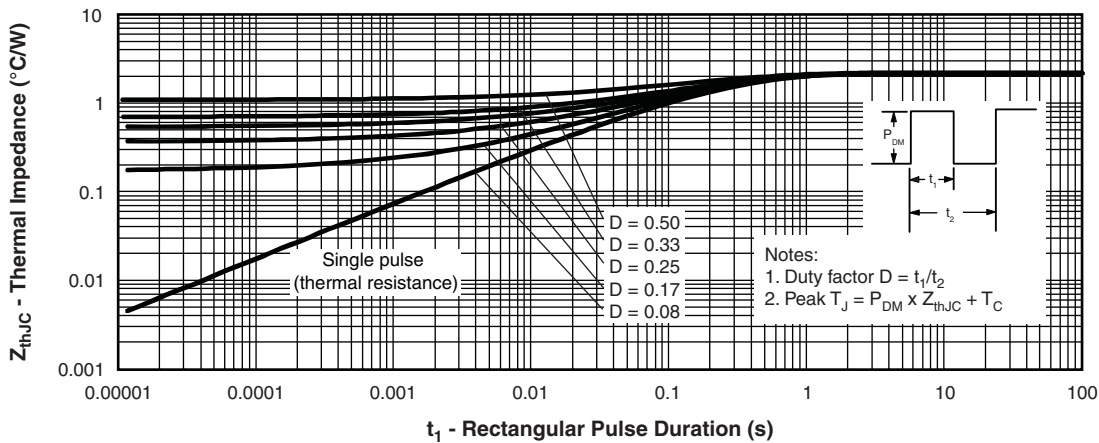

Fig. 4 - Maximum Thermal Impedance Z_{thJC} Characteristics (Per Leg)

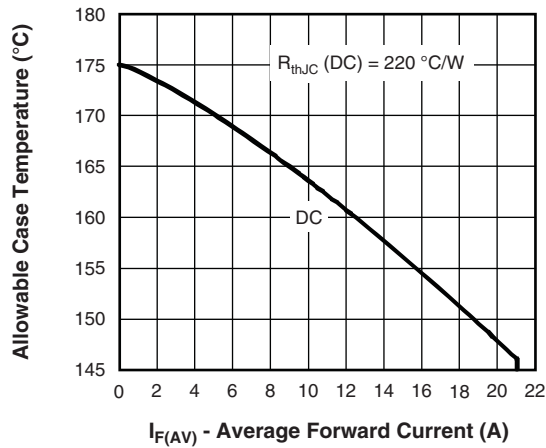

Fig. 5 - Maximum Allowable Case Temperature vs. Average Forward Current (Per Leg)

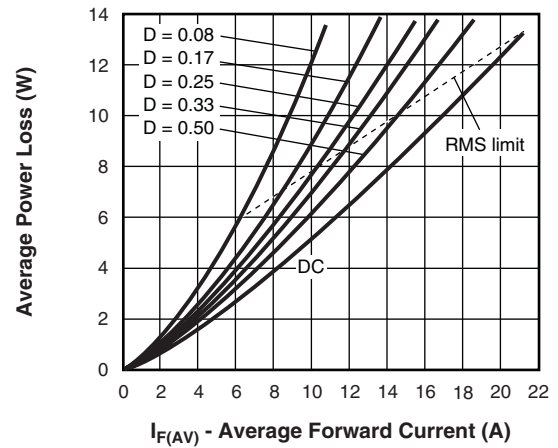

Fig. 6 - Forward Power Loss Characteristics (Per Leg)

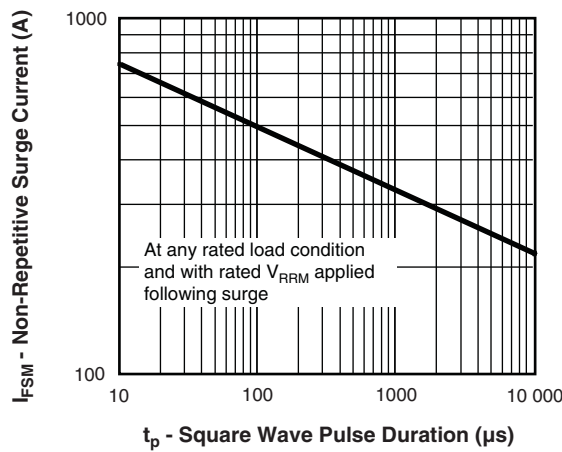

Fig. 7 - Maximum Non-Repulsive Surge Current (Per Leg)

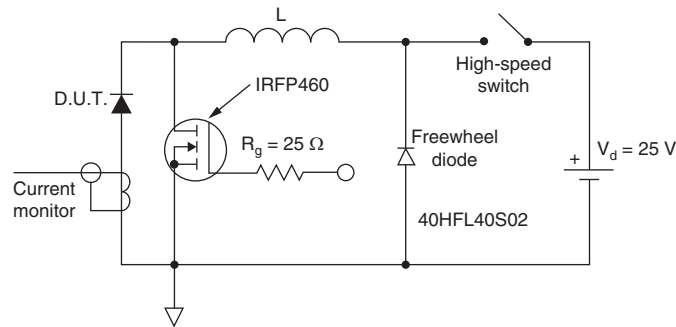
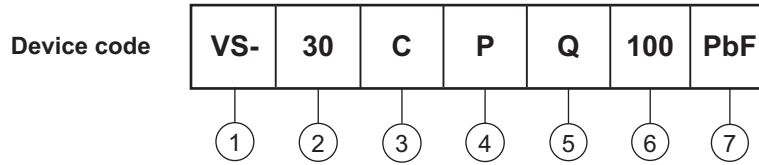

Fig. 8 - Unclamped Inductive Test Circuit



ORDERING INFORMATION TABLE



- 1** - Vishay Semiconductors product
 - 2** - Current rating
 - 3** - Circuit configuration:
C = Common cathode
 - 4** - Package:
P = TO-247
 - 5** - Schottky "Q" series
 - 6** - Voltage code
 - 7** - Environmental digit
- 080 = 80 V
 090 = 90 V
 100 = 100 V
- PbF = Lead (Pb)-free and RoHS compliant
 - -N3 = Halogen-free, RoHS compliant, and totally lead (Pb)-free

ORDERING INFORMATION (Example)			
PREFERRED P/N	QUANTITY PER T/R	MINIMUM ORDER QUANTITY	PACKAGING DESCRIPTION
VS-30CPQ080PbF	25	500	Antistatic plastic tube
VS-30CPQ080-N3	25	500	Antistatic plastic tube
VS-30CPQ090PbF	25	500	Antistatic plastic tube
VS-30CPQ090-N3	25	500	Antistatic plastic tube
VS-30CPQ100PbF	25	500	Antistatic plastic tube
VS-30CPQ100-N3	25	500	Antistatic plastic tube

LINKS TO RELATED DOCUMENTS	
Dimensions	www.vishay.com/doc?95223
Part marking information	TO-247AC PbF www.vishay.com/doc?95226
	TO-247AC -N3 www.vishay.com/doc?95007
SPIICE model	www.vishay.com/doc?95470

TO-247AC

DIMENSIONS in millimeters and inches

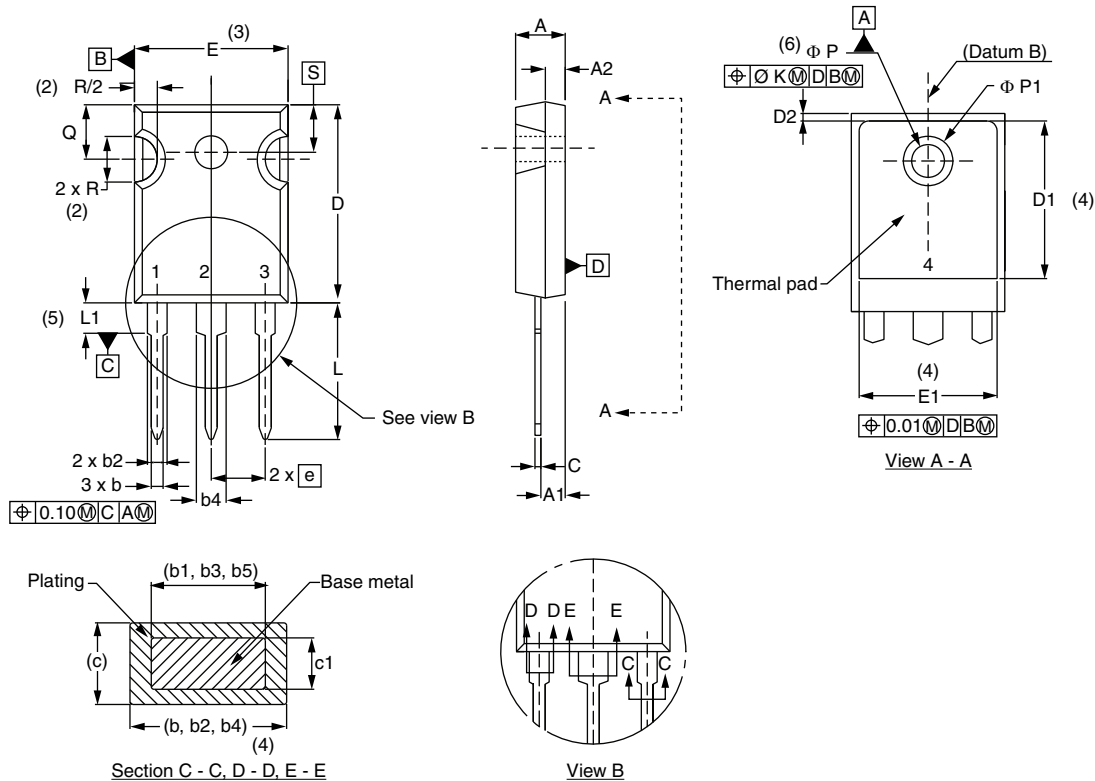

SYMBOL	MILLIMETERS		INCHES		NOTES	SYMBOL	MILLIMETERS		INCHES		NOTES
	MIN.	MAX.	MIN.	MAX.			MIN.	MAX.	MIN.	MAX.	
A	4.65	5.31	0.183	0.209		D2	0.51	1.30	0.020	0.051	
A1	2.21	2.59	0.087	0.102		E	15.29	15.87	0.602	0.625	3
A2	1.50	2.49	0.059	0.098		E1	13.72	-	0.540	-	
b	0.99	1.40	0.039	0.055		e	5.46 BSC		0.215 BSC		
b1	0.99	1.35	0.039	0.053		ϕK	2.54		0.010		
b2	1.65	2.39	0.065	0.094		L	14.20	16.10	0.559	0.634	
b3	1.65	2.34	0.065	0.092		L1	3.71	4.29	0.146	0.169	
b4	2.59	3.43	0.102	0.135		ϕP	3.56	3.66	0.14	0.144	
b5	2.59	3.38	0.102	0.133		$\phi P1$	-	6.98	-	0.275	
c	0.38	0.89	0.015	0.035		Q	5.31	5.69	0.209	0.224	
c1	0.38	0.84	0.015	0.033		R	4.52	5.49	0.178	0.216	
D	19.71	20.70	0.776	0.815	3	S	5.51 BSC		0.217 BSC		
D1	13.08	-	0.515	-	4						

Notes

- (1) Dimensioning and tolerancing per ASME Y14.5M-1994
- (2) Contour of slot optional
- (3) Dimension D and E do not include mold flash. Mold flash shall not exceed 0.127 mm (0.005") per side. These dimensions are measured at the outermost extremes of the plastic body
- (4) Thermal pad contour optional with dimensions D1 and E1
- (5) Lead finish uncontrolled in L1
- (6) ϕP to have a maximum draft angle of 1.5 to the top of the part with a maximum hole diameter of 3.91 mm (0.154")
- (7) Outline conforms to JEDEC® outline TO-247 with exception of dimension c



Disclaimer

ALL PRODUCT, PRODUCT SPECIFICATIONS AND DATA ARE SUBJECT TO CHANGE WITHOUT NOTICE TO IMPROVE RELIABILITY, FUNCTION OR DESIGN OR OTHERWISE.

Vishay Intertechnology, Inc., its affiliates, agents, and employees, and all persons acting on its or their behalf (collectively, "Vishay"), disclaim any and all liability for any errors, inaccuracies or incompleteness contained in any datasheet or in any other disclosure relating to any product.

Vishay makes no warranty, representation or guarantee regarding the suitability of the products for any particular purpose or the continuing production of any product. To the maximum extent permitted by applicable law, Vishay disclaims (i) any and all liability arising out of the application or use of any product, (ii) any and all liability, including without limitation special, consequential or incidental damages, and (iii) any and all implied warranties, including warranties of fitness for particular purpose, non-infringement and merchantability.

Statements regarding the suitability of products for certain types of applications are based on Vishay's knowledge of typical requirements that are often placed on Vishay products in generic applications. Such statements are not binding statements about the suitability of products for a particular application. It is the customer's responsibility to validate that a particular product with the properties described in the product specification is suitable for use in a particular application. Parameters provided in datasheets and / or specifications may vary in different applications and performance may vary over time. All operating parameters, including typical parameters, must be validated for each customer application by the customer's technical experts. Product specifications do not expand or otherwise modify Vishay's terms and conditions of purchase, including but not limited to the warranty expressed therein.

Except as expressly indicated in writing, Vishay products are not designed for use in medical, life-saving, or life-sustaining applications or for any other application in which the failure of the Vishay product could result in personal injury or death. Customers using or selling Vishay products not expressly indicated for use in such applications do so at their own risk. Please contact authorized Vishay personnel to obtain written terms and conditions regarding products designed for such applications.

No license, express or implied, by estoppel or otherwise, to any intellectual property rights is granted by this document or by any conduct of Vishay. Product names and markings noted herein may be trademarks of their respective owners.