

PSA05-11EWA/SRWA/YWA/GWA  
 PSC05-11EWA/SRWA/YWA/GWA  
 PSA05-12EWA/SRWA/YWA/GWA  
 PSC05-12EWA/SRWA/YWA/GWA

### Features

- 0.5 INCH CHARACTER HEIGHT.
- LOW CURRENT OPERATION.
- HIGH CONTRAST AND LIGHT OUTPUT.
- COMMON CATHODE AND COMMON ANODE AVAILABLE.
- EASY MOUNTING ON P.C. BOARDS OR SOCKETS.
- CATEGORIZED FOR LUMINOUS INTENSITY, YELLOW AND GREEN CATEGORIZED FOR COLOR.
- MECHANICALLY RUGGED.
- STANDARD : GRAY FACE, WHITE SEGMENT.

### Description

The High Efficiency Red source color devices are made with Gallium Arsenide Phosphide on Gallium Phosphide Orange Light Emitting Diode.

The Super Bright Red source color devices are made with Gallium Aluminum Arsenide Red Light Emitting Diode.

The Yellow source color devices are made with Gallium Arsenide Phosphide on Gallium Phosphide Yellow Light Emitting Diode.

The Green source color devices are made with Gallium Phosphide GreenLight Emitting Diode.

### Package Dimensions & Internal Circuit Diagram

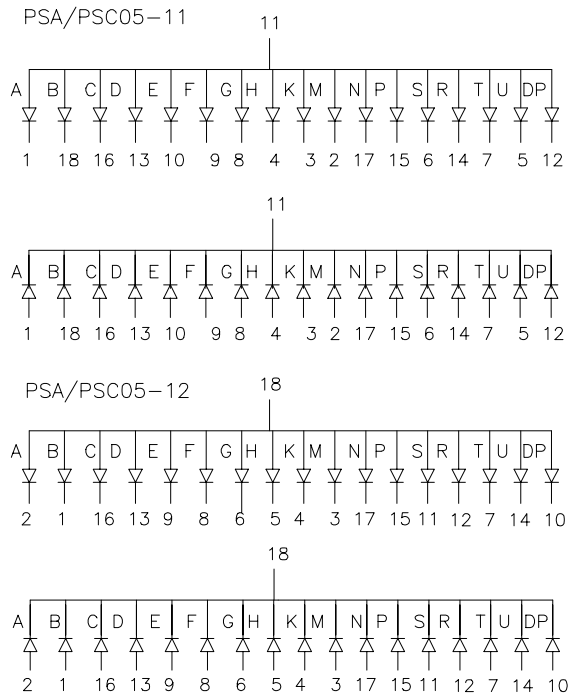
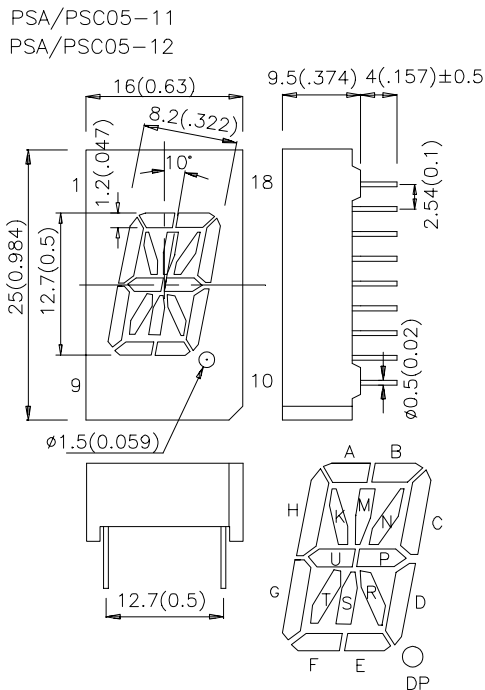

#### Notes:

1. All dimensions are in millimeters (inches), Tolerance is  $\pm 0.25(0.01)$  unless otherwise noted.
2. Specifications are subject to change without notice.

## Selection Guide

Part No.	Dice	Iv (ucd) @ 10 mA		Description
		Min.	Typ.	
PSA05-11EWA PSA05-12EWA	HIGH EFFICIENCY RED (GaAsP/GaP)	1200	4100	Common Anode, Rt. Hand Decimal
PSC05-11EWA PSC05-12EWA				Common Cathode, Rt. Hand Decimal
PSA05-11SRWA PSA05-12SRWA	SUPER BRIGHT RED (GaAlAs)	8000	18000	Common Anode, Rt. Hand Decimal
PSC05-11SRWA PSC05-12SRWA				Common Cathode, Rt. Hand Decimal
PSA05-11YWA PSA05-12YWA	YELLOW (GaAsP/GaP)	1200	3000	Common Anode, Rt. Hand Decimal
PSC05-11YWA PSC05-12YWA				Common Cathode, Rt. Hand Decimal
PSA05-11GWA PSA05-12GWA	GREEN (GaP)	1900	4700	Common Anode, Rt. Hand Decimal
PSC05-11GWA PSC05-12GWA				Common Cathode, Rt. Hand Decimal

## Electrical / Optical Characteristics at T<sub>A</sub>=25°C

Symbol	Parameter	Device	Typ.	Max.	Units	Test Conditions
$\lambda_{peak}$	Peak Wavelength	High Efficiency Red Super Bright Red Yellow Green	627 660 590 565		nm	I <sub>F</sub> =20mA
$\lambda_D$	Dominate Wavelength	High Efficiency Red Super Bright Red Yellow Green	625 640 588 568		nm	I <sub>F</sub> =20mA
$\Delta\lambda_{1/2}$	Spectral Line Half-width	High Efficiency Red Super Bright Red Yellow Green	45 20 35 30		nm	I <sub>F</sub> =20mA
C	Capacitance	High Efficiency Red Super Bright Red Yellow Green	15 45 20 15		pF	V <sub>F</sub> =0V;f=1MHz
V <sub>F</sub>	Forward Voltage	High Efficiency Red Super Bright Red Yellow Green	2.0 1.85 2.1 2.2	2.5 2.5 2.5 2.5	V	I <sub>F</sub> =20mA
I <sub>R</sub>	Reverse Current	All		10	uA	V <sub>R</sub> = 5V

## Absolute Maximum Ratings at $T_A=25^\circ\text{C}$

Parameter	High Efficiency Red	Super Bright Red	Yellow	Green	Units
Power dissipation	105	100	105	105	mW
DC Forward Current	30	30	30	25	mA
Peak Forward Current [1]	160	155	140	140	mA
Reverse Voltage	5	5	5	5	V
Operating/Storage Temperature	-40°C To +85°C				
Lead Solder Temperature [2]	260°C For 5 Seconds				

**Notes:**

- 1/10 Duty Cycle, 0.1ms Pulse Width.
- 2mm below package base.

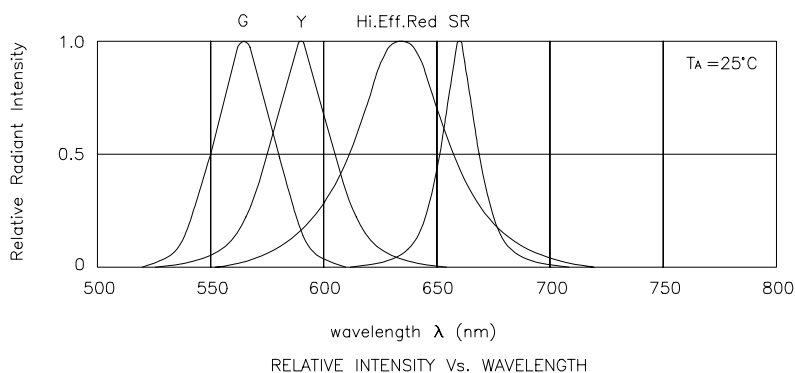

## High Efficiency Red

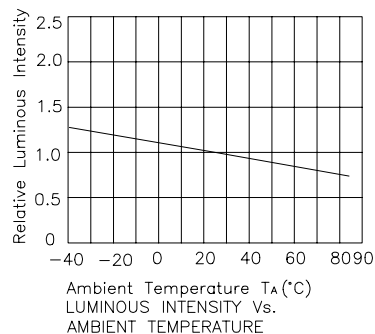
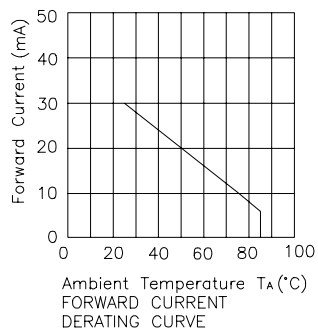
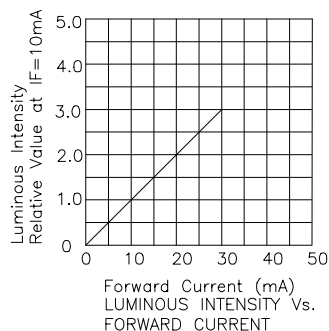
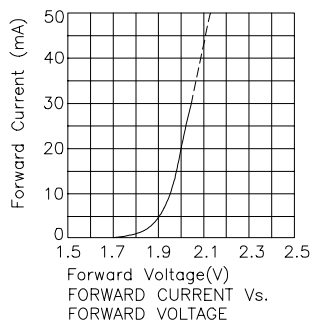

## Super Bright Red

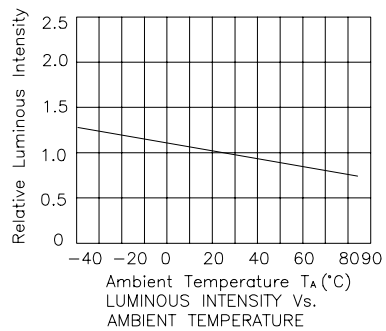
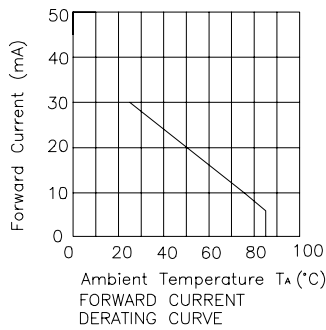
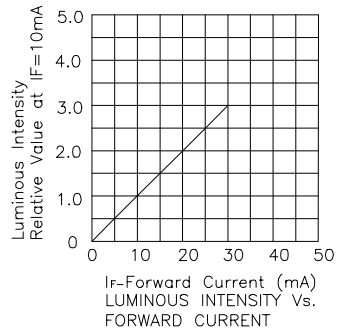
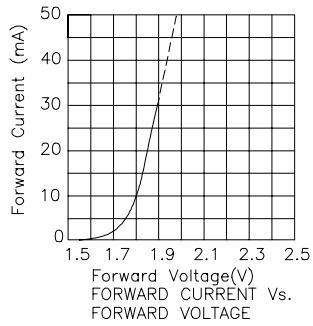

## Yellow

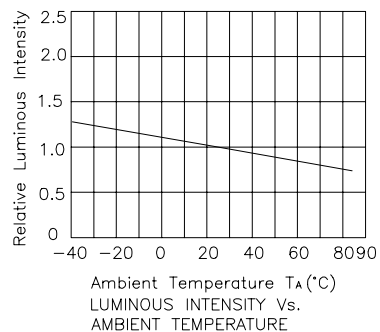
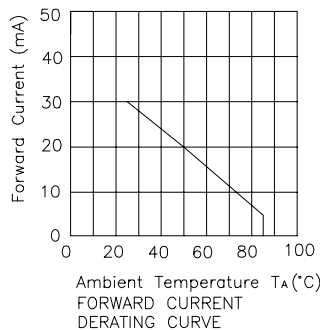
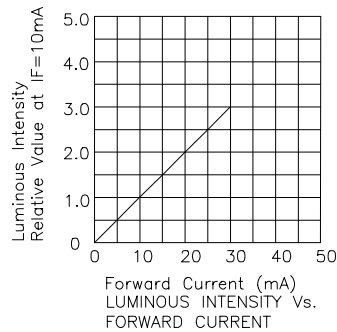
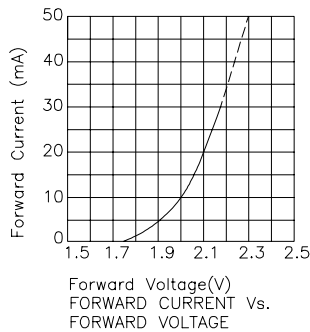

## Green

