

KEMET Part Number: SC-02-200
(UALSC022000000)

KEMET, SC, AC Line Filters, Common Mode, 2000 uH

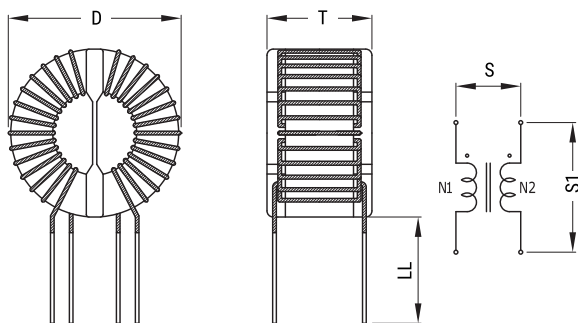

Dimensions

D	23mm MAX
T	18.5mm MAX
LL	15mm +/-2mm
S	6mm NOM

Packaging Specifications

Packaging:	Tray
Packaging Quantity:	300
Weight:	15 g

General Information

Series:	SC
Style:	Through-Hole
RoHS:	Yes
Notes:	Lead Spacing (S/S1) Are For Reference Only.
Miscellaneous:	Temperature Rise Maximum: 40 K

Specifications

Voltage AC:	250 VAC
Inductance:	2 mH (100 kHz)
Current:	2 A
Temperature Range:	-25/+105°C
DC Resistance:	110 mOhms