

# 億力光電股份有限公司

## EVERVISION ELECTRONICS CO., LTD.

### Product Specification For LCD Module

(KVPF-7B-002-16)

Model NO. : VGG106004-6UFLWE(RoHS)

REVISION : 2

APPROVAL FOR SPECIFICATIONS ONLY

APPROVAL FOR SPECIFICATIONS AND SAMPLE

CUSTOMER :

STD.

APPROVED BY :

### EVERVISION LCM R&D CENTER

APPROVED BY

CHECKED BY

PREPARED BY

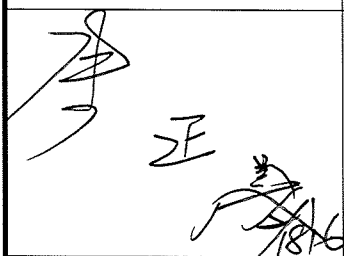

DIRECTOR

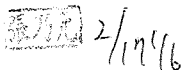

MANAGER

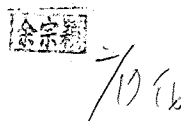

Mechanism Engineer

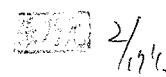

Electronic Engineer

億力光電股份有限公司總公司

EVERVISION ELECTRONICS CO., LTD.

台北市中和區建一路 186 號 6 樓之 5  
6F.-5, No.186, Jian 1st Rd., Zhonghe Dist.,  
New Taipei City 235, Taiwan (R.O.C.)

TEL : +886 2 8227-2788

FAX : +886 2 8227-2799

億力光電股份有限公司台中分公司

EVERVISION ELECTRONICS CO., LTD.

-Taichung Branch

台中市潭子區建國路 19 號  
No.19, Jianguo Rd., Tanzi Dist.,  
Taichung City 427, Taiwan (R.O.C.)

TEL : +886 4 2532-8889

FAX : +886 4 2532-6689

勁佳光電(昆山)有限公司

VBEST ELECTRONICS(KUNSHAN) Co., Ltd.

江蘇省昆山市玉山鎮高科技工業園城北路 8 號  
No.8, Chengbei Rd., Hi-Tech Industry Park,  
Yushan Town, Kunshan City, Jiangsu, China.

TEL : +86 512 5778 7288

FAX : +86 512 5777 0688

勁佳光電(昆山)有限公司東莞分公司

VBEST ELECTRONICS(KUNSHAN)Co.,Ltd.

- DongGuan Branch

東莞市莞城區東縱大道天寶路 23 號  
No.23 Tian Bao Rd., Dong Zong St.,  
Dong Guan City, Guang Dong, China.

TEL : +86 769 3887 5000

FAX : +86 769 3896 0580

<http://www.evervisionlcd.com>

<b>EVERVISION</b>	<b>MODEL NO.</b>		<b>PAGE</b>
	VGG106004-6UFLWE	SPEC SAMPLE	2

## 1. Table of Contents

<b>No.</b>	<b>Contents</b>	<b>Page</b>
1	Table of Contents	2
2	Record of Revisions	3
3	Module Numbering System	4
4	Application	5
5	Features	5
6	General Specifications	5
7	Absolute Maximum Ratings	6
8	Electrical Characteristics	7
9	Block Diagram	10
10	Input / Output Terminals Pin Assignment	11
11	Interface Timing	15
12	Optical Characteristics	27
13	Reliability Test	30
14	Packaging	31
15	Precautions	32
16	Outline Drawing	34
17	Definition of Labels	35
18	Incoming Inspection Standards	37



<b>EVERVISION</b>	<b>MODEL NO.</b>		<b>PAGE</b>
	VGG106004-6UFLWE	SPEC SAMPLE	4

### 3. Module Numbering System

**V G G 1060 04 – 6 U F L W E**

Serial No.: A~Z

Backlight Color:  
**N**:Without Backlight;  
**A**:Amber; **B**:Blue; **G**:Green;  
**L**:Yellow; **O**:Orange; **R**:Red;  
**W**:White; **Y**:YellowGreen;  
**X**:Others

Backlight Type:  
**N**:Without Backlight; **E**:EL; **F**:CCFL;  
**L**:General LED; **H**:High NTSC LED ;  
**R**:RGB LED; **X**:Others

LCD Model:  
**A**:ASTN; **B**:STN Blue; **C**:CSTN; **D**:DSTN;  
**F**:TFT; **G**:STN Gray; **H**:HTN; **I**:IBN;  
**K**:Black Mask TN **L**:LTPS; **M**:MVA;  
**N**:others; **O**:OLED; **P**:PLED; **S**:IPS;  
**T**:TN; **U**:FSC TN; **W**:FSTN Black/white;  
**X**:FFSTN; **Y**:STN Yellow;

LCD Type:  
**R**: Reflective/Positive;  
**S**: Reflective/Negative ;  
**F**: Transflective/Positive ;  
**G**: Transflective/Negative ;  
**U**: Transmissive/Positive ;  
**T**: Transmissive/Negative ; **N**:Others

Temperature Range & View Direction:  
General Purpose : **1**:6H **2**:12H **3**:3H **4**:9H **5**:Others  
High Performance: **6**:6H **7**:12H **8**:3H **9**:9H **0**:Others

STD Product Serial No.: 01~99  
Customer Made Serial No.: A1,A2...A9,B1,B2...B9,C1..

Display Function:  
Segment Number / Characters Lines / Column and Row Dots  
/ Length \* Width of Other

Display Type:  
**C**:Character Type; **G**:Graphic Type; **S**:Segment Type; **O**:Other

Package Type:  
**B**:COB; **F**:COF; **G**:COG; **H**:Heat Seal; **S**:SMT; **T**:TAB; **O**:Others

<b>EVERVISION</b>	<b>MODEL NO.</b>		<b>PAGE</b>
	VGG106004-6UFLWE	SPEC SAMPLE	5

#### 4. Application

This specification is applied to the 7 inch WSVGA supported TFT-LCD module With projected capacitive touch (PCT) and can display true 16.7M colors (RGB 6-bits + HiFRC data). The module is designed for OA, Car TV application and other electronic products which require flat panel display of digital signal interface. This module is composed of a 7" TFT-LCD panel, a driver circuit and backlight unit and used as the input devices for general electric appliances via both finger and Capacitive stylus pen.

#### 5. Features

- WSVGA (1024×600 pixels) resolution.
- 8 bit LVDS Interface.
- Dot inversion mode with stripe type.
- Projected Capacitive Touch
  - I<sup>2</sup>C Interface
  - Multi Touch (Ten points)

#### 6. General Specifications

Item	Specifications	Unit
Screen Size	7 (Diagonal)	inch
Display Format	1024RGB(H)×600(V)	dot
Active Area	153.6(H)×86.64(V)	mm
Pixel Pitch	0.15(H)×0.1444(V)	mm
Pixel Configuration	RGB Vertical Stripe	-
Display Mode	TN Type Transmissive Mode Normally White	-
Surface Treatment	Clear(7H)	-
Viewing Direction	6 O'clock (The Gray Inversion will appear at this direction)	-
Outline Dimension	165.0(W)×104.0(H)×5.05(D)	mm
Weight	178	g
RoHS Compliance	Evervision certifies this product to be in compliance with European Union Directive 2011/65/EU on the restriction of certain hazardous substances in electrical and electronic equipment.	-

<b>EVERVISION</b>	<b>MODEL NO.</b>		<b>PAGE</b>
	VGG106004-6UFLWE	SPEC SAMPLE	6

## 7. Absolute Maximum Ratings

### 7.1 Absolute Ratings of Environment

Item	Symbol	Value		Unit	Note
		Min.	Max.		
Storage Temperature	T <sub>ST</sub>	-30	+80	°C	(1)(2)
Operating Ambient Temperature	T <sub>OP</sub>	-20	+70	°C	(1)(2)

Note1: Background color changes slightly depending on ambient temperature.

This phenomenon is reversible.

Note2: Please refer to item of RELIABILITY.

### 7.2 Electrical Absolute Ratings

#### 7.2.1 TFT-LCD Module

(Ta=25±2°C)

Item	Symbol	Value		Unit	Note
		Min.	Max.		
Digital Power Supply Voltage	DV <sub>DD</sub>	-0.3	5.0	V	-
Analog Power Supply Voltage	AV <sub>DD</sub>	6.5	13.5	V	-
Gate High Voltage	V <sub>GH</sub>	-0.3	40	V	-
Gate Low Voltage	V <sub>GL</sub>	-20.0	0.3	V	-
Gate High To Gate Low Voltage	V <sub>GH</sub> - V <sub>GL</sub>	-	40	V	-

#### 7.2.2 Backlight Unit

(Ta=25±2°C)

Item	Symbol	Value		Unit	Note
		Min.	Max.		
LED Reverse Voltage	VR	-	5	V	Each LED
LED Forward Current	IF	-	30	mA	Each LED
Current of Backlight Unit	I <sub>B</sub>	-	210	mA	(1)
Voltage of Backlight Unit	V <sub>B</sub>	-	20	V	(1)

Note (1) Permanent damage to the device may occur if maximum values are exceeded or reverse voltage is loaded.

<b>EVERVISION</b>	<b>MODEL NO.</b>		<b>PAGE</b>
	VGG106004-6UFLWE	SPEC SAMPLE	7

## 8. Electrical Characteristics

### 8.1 TFT-LCD Module

(Ta=25±2°C)

Item	Symbol	Value			Unit	Note
		Min.	Typ.	Max.		
Digital Power Supply Voltage	V <sub>DD</sub>	3.0	3.3	3.6	V	-
Analog Power Supply Voltage	AV <sub>DD</sub>	9.2	9.5	9.8	V	-
Gate High Voltage	V <sub>GH</sub>	17.7	18	18.3	V	-
Gate Low Voltage	V <sub>GL</sub>	-10.3	-10	-9.7	V	-
Input signal voltage	V <sub>COM</sub>	1.98	2.38	2.78	V	(3)
Input logic high voltage	V <sub>IH</sub>	0.7 V <sub>DD</sub>	-	V <sub>DD</sub>	V	(2)
Input logic low voltage	V <sub>IL</sub>	0	-	0.3 V <sub>DD</sub>	V	
Gate High Voltage Current	I <sub>GH</sub>	-	0.31	0.62	mA	(1)
Gate Low Voltage Current	I <sub>GL</sub>	-	1.0	2.0	mA	(1)
Digital Power Supply Current	I <sub>DD</sub>	-	33	66	mA	(1)
Analog Power Supply Current	I <sub>A DD</sub>	-	18	36	mA	(1)
signal voltage Current	I <sub>COM</sub>	-	2.0	4.0	mA	(1)
Differential Input High Threshold Voltage	RX <sub>VTH</sub>	-	-	0.1	V	RXVCM=1.2V
Differential Input Low Threshold Voltage	RX <sub>VTL</sub>	-0.1	-	-	V	
Input voltage range (singled-end)	RxVIN	0	-	2.4	V	-
Differential input common mode voltage	RxVCM	VID /2	-	2.4 -  VID /2	V	-
Differential voltage	VID	0.2	-	0.6	V	-
Differential input leakage current	RVxliz	-10	-	+10	uA	-
DCLK Frequency	DCLK	-	51.2	-	MHz	-

Note (1) The specified power consumption is under the conditions at V<sub>DD</sub> =3.3V, DCLK =51.2MHz, whereas a power dissipation check pattern below is displayed.

Note (2): LVDS, Reset.

Note (3): Typ. VCOM is only a reference value, it must be optimized according to each LCM. Be sure to use VR;

Black Pattern / 0 Gray

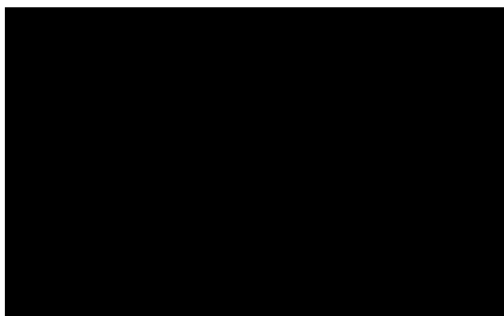

Active Area

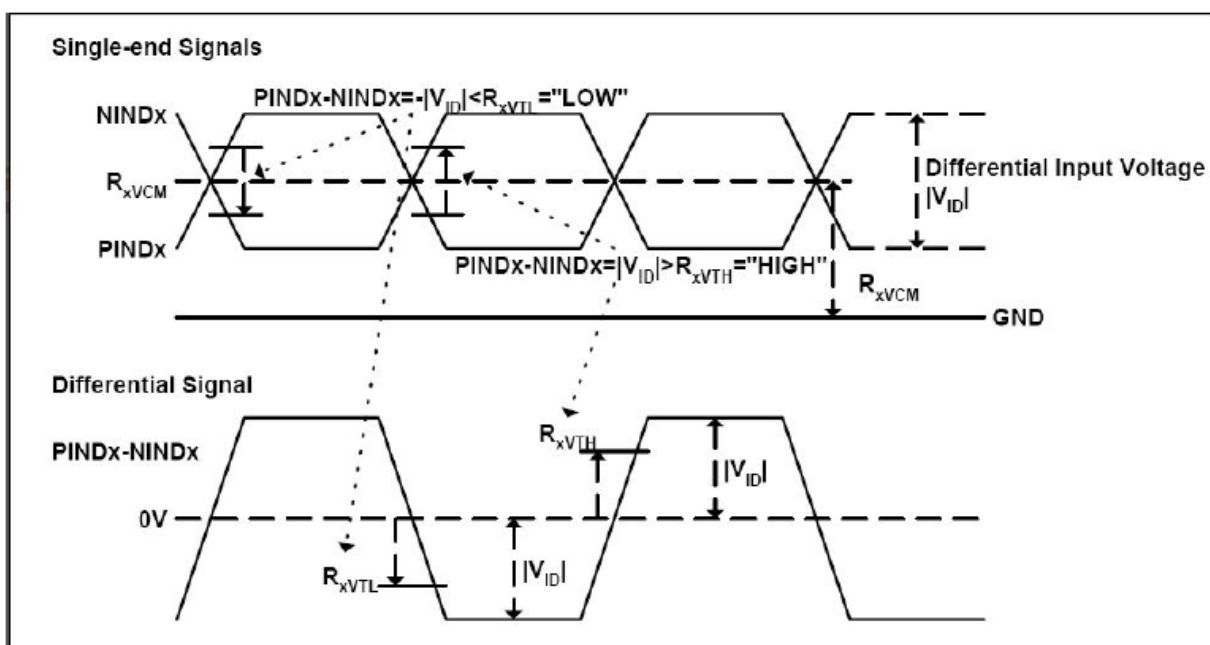

**8.2 Backlight Unit**

(Ta=25±2°C)

Item	Symbol	Value			Unit	Note
		Min.	Typ.	Max.		
Voltage of Backlight Unit	V <sub>B</sub>	-	12.8	13.6	V	-
Current of Backlight Unit	I <sub>B</sub>	-	140	-	mA	(2)
LED Life Time(25°C)	-	50000	-	-	hr	(1)(2)

Note (1) LED life time (Hr) can be defined as the time in which it continues to operate under the condition: Ta=25±3 °C, typical IL value indicated in the above table until the brightness becomes less than 50%.

Note (2) The “LED life time” is defined as the module brightness decrease to 50% original brightness at Ta=25°C and IL=140mA. The LED lifetime could be decreased if operating IL is larger than 140mA. The constant current driving method is suggested.



### 8.3 Projected Capacitive Touch

Item	Symbol	Value			Unit	Note
		Min.	Typ.	Max.		
Operating Voltage	VDD	3.0	3.3	3.6	V	-
Power Supply Current	IDD	-	20.5	28.7	mA	(1)
Input High Threshold Voltage	V <sub>IH</sub>	0.7VDD	-	VDD	V	-
Input Low Threshold Voltage	V <sub>IL</sub>	-0.3	-	0.3VDD	V	-
Output High Threshold Voltage	V <sub>OH</sub>	0.7VDD	-	-	V	-
Output Low Threshold Voltage	V <sub>OL</sub>	-	-	0.3VDD	V	-
Power Consumption	P <sub>L</sub>	-	67.65	94.71	mW	@3.3V
Report Rate	R <sub>R</sub>	-	60	-	Hz	-
Interface		I <sup>2</sup> C				-
Function		Multi Touch				-

Note (1) This test condition is touched with 10 points.

**9. Block Diagram**

**9.1 TFT-LCD Module with Backlight Unit**

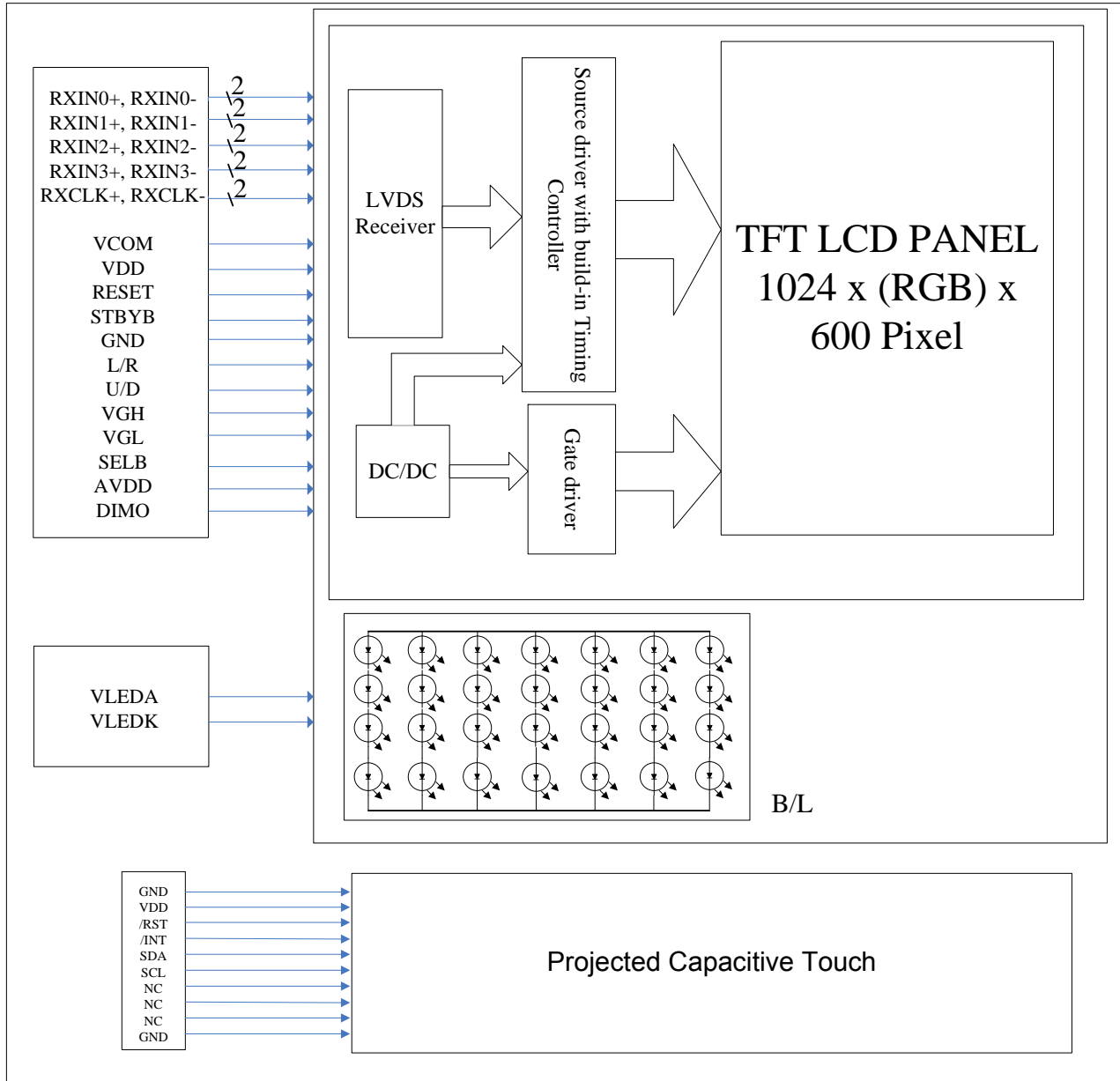

<b>EVERVISION</b>	<b>MODEL NO.</b>		<b>PAGE</b>
	VGG106004-6UFLWE	SPEC SAMPLE	11

## 10. Input / Output Terminals Pin Assignment

### 10.1 TFT-LCD Module

FPC Connector is used for the module electronics interface. The recommended model is FH12A-40S-0.5SH manufactured by Hirose.

Pin No.	Symbol	I/O	Function	Remark
1	VCOM	P	Common Voltage	
2	VDD	P	Power Voltage for digital circuit	
3	VDD	P	Power Voltage for digital circuit	
4	NC	---	No connection	
5	Reset	I	Global reset pin	
6	STBYB	I	Standby mode, Normally pulled high STBYB = "1", normal operation STBYB = "0", timing controller, source driver will turn off, all output are High-Z	
7	GND	P	Ground	
8	RXIN0-	I	- LVDS differential data input	
9	RXIN0+	I	+ LVDS differential data input	
10	GND	P	Ground	
11	RXIN1-	I	- LVDS differential data input	
12	RXIN1+	I	+ LVDS differential data input	
13	GND	P	Ground	
14	RXIN2-	I	- LVDS differential data input	
15	RXIN2+	I	+ LVDS differential data input	
16	GND	P	Ground	
17	RXCLKIN-	I	- LVDS differential clock input	
18	RXCLKIN+	I	+ LVDS differential clock input	
19	GND	P	Ground	
20	RXIN3-	I	- LVDS differential data input	
21	RXIN3+	I	+ LVDS differential data input	
22	GND	P	Ground	

<b>EVERVISION</b>	<b>MODEL NO.</b>		<b>PAGE</b>
	VGG106004-6UFLWE	SPEC SAMPLE	12

23	NC	---	No connection	
24	NC	---	No connection	
25	GND	P	Ground	
26	NC	---	No connection	
27	DIMO	O	Backlight CABC controller signal output	
28	SELB	I	6bit/8bit mode select	Note1
29	AVDD	P	Power for Analog Circuit	
30	GND	P	Ground	
31	LED-	P	No connection	
32	LED-	P	No connection	
33	L/R	I	Horizontal inversion	Note3
34	U/D	I	Vertical inversion	Note3
35	VGL	P	Gate OFF Voltage	
36	NC		No connector	
37	NC		No connector	
38	VGH	P	Gate ON Voltage	
39	LED+	P	No connection	
40	LED+	P	No connection	

**I: input O: Output P: Power**

**Note1: Global reset pin: Active low to enter reset mode. Suggest connecting with an RC reset circuit for**

**stability. Normally pull high. (R=10KΩ, C=0.1μF)**

**Note1: If RC is not added, users must follow the rule, T2 > 50ms on page 18 item 6.5 power on/off sequence.**

**Note2: If LVDS input data is 6 bits ,SELB must be set to High;**

**If LVDS input data is 8 bits, SELB must be set to Low.**

**Note3: When L/R=" 0" , set right to left scan direction.**

**When L/R="1", set left to right scan direction.**

**When U/D="0", set top to bottom scan direction.**

**When U/D="1", set bottom to top scan direction.**

## 10.2 Backlight Unit

Connector: JST BHSR-02VS-1(N)

Pin No.	Symbol	I/O	Description	Wire Color
1	VLEDA	I	Backlight LED Anode.	Red
2	VLEDC	I	Backlight LED Cathode.	Black

## 10.3 Improved Projected Capacitive Touch

Connector: CVILUX CF25101D0R0-05

Pin No.	Symbol	I/O	Description
1	GND	I	System ground.
2	VDD	I	+3.3V power supply.
3	/RST	I	External reset signal, active low.
4	/INT	O	Interrupt signal, active low, asserted to request Host start a new transaction.
5	SDA	I/O	I <sup>2</sup> C data signal.
6	SCL	I	I <sup>2</sup> C clock signal.
7	NC	-	Not Connection
8	NC	-	Not Connection
9	NC	-	Not Connection
10	GND	I	System ground.

### 10.4 Color Data Input Assignment

The brightness of each primary color(red, green and blue) is based on the 8 bit gray scale data input for the color. The higher the binary input, the brighter the color. The table provides the assignment of color versus data input.

Color		Data Signal																							
		Red								Green								Blue							
		R7	R6	R5	R4	R3	R2	R1	R0	G7	G6	G5	G4	G3	G2	G1	G0	B7	B6	B5	B4	B3	B2	B1	B0
Basic Colors	Black	0	0	0	0	0	0	0	0	0	0	0	0	0	0	0	0	0	0	0	0	0	0	0	
	Red	1	1	1	1	1	1	1	1	0	0	0	0	0	0	0	0	0	0	0	0	0	0	0	
	Green	0	0	0	0	0	0	0	0	1	1	1	1	1	1	1	0	0	0	0	0	0	0	0	
	Blue	0	0	0	0	0	0	0	0	0	0	0	0	0	0	0	1	1	1	1	1	1	1	1	
	Cyan	0	0	0	0	0	0	0	0	1	1	1	1	1	1	1	1	1	1	1	1	1	1	1	
	Magenta	1	1	1	1	1	1	1	1	0	0	0	0	0	0	0	1	1	1	1	1	1	1	1	
	Yellow	1	1	1	1	1	1	1	1	1	1	1	1	1	1	1	0	0	0	0	0	0	0	0	
	White	1	1	1	1	1	1	1	1	1	1	1	1	1	1	1	1	1	1	1	1	1	1	1	
Gray Scale Of RED	Red(0) / Dark	0	0	0	0	0	0	0	0	0	0	0	0	0	0	0	0	0	0	0	0	0	0		
	Red(1)	0	0	0	0	0	0	1	0	0	0	0	0	0	0	0	0	0	0	0	0	0	0		
	Red(2)	0	0	0	0	0	0	1	0	0	0	0	0	0	0	0	0	0	0	0	0	0	0		
	:	:	:	:	:	:	:	:	:	:	:	:	:	:	:	:	:	:	:	:	:	:	:		
	:	:	:	:	:	:	:	:	:	:	:	:	:	:	:	:	:	:	:	:	:	:	:		
	Red(253)	1	1	1	1	1	1	0	1	0	0	0	0	0	0	0	0	0	0	0	0	0	0		
	Red(254)	1	1	1	1	1	1	1	0	0	0	0	0	0	0	0	0	0	0	0	0	0	0		
	Red(255)	1	1	1	1	1	1	1	1	0	0	0	0	0	0	0	0	0	0	0	0	0	0		
Gray Scale Of Green	Green(0) / Dark	0	0	0	0	0	0	0	0	0	0	0	0	0	0	0	0	0	0	0	0	0	0		
	Green(1)	0	0	0	0	0	0	0	0	0	0	0	0	0	0	1	0	0	0	0	0	0	0		
	Green(2)	0	0	0	0	0	0	0	0	0	0	0	0	0	1	0	0	0	0	0	0	0	0		
	:	:	:	:	:	:	:	:	:	:	:	:	:	:	:	:	:	:	:	:	:	:	:		
	:	:	:	:	:	:	:	:	:	:	:	:	:	:	:	:	:	:	:	:	:	:	:		
	Green(253)	0	0	0	0	0	0	0	0	1	1	1	1	1	1	0	1	0	0	0	0	0	0		
	Green(254)	0	0	0	0	0	0	0	0	1	1	1	1	1	1	0	0	0	0	0	0	0	0		
	Green(255)	0	0	0	0	0	0	0	0	1	1	1	1	1	1	1	0	0	0	0	0	0	0		
Gray Scale Of Blue	Blue(0) / Dark	0	0	0	0	0	0	0	0	0	0	0	0	0	0	0	0	0	0	0	0	0	0		
	Blue(1)	0	0	0	0	0	0	0	0	0	0	0	0	0	0	0	0	0	0	0	0	0	1		
	Blue(2)	0	0	0	0	0	0	0	0	0	0	0	0	0	0	0	0	0	0	0	0	0	1		
	:	:	:	:	:	:	:	:	:	:	:	:	:	:	:	:	:	:	:	:	:	:	:		
	:	:	:	:	:	:	:	:	:	:	:	:	:	:	:	:	:	:	:	:	:	:	:		
	Blue(253)	0	0	0	0	0	0	0	0	0	0	0	0	0	0	0	1	1	1	1	1	1	0		
	Blue(254)	0	0	0	0	0	0	0	0	0	0	0	0	0	0	0	1	1	1	1	1	1	0		
	Blue(255)	0	0	0	0	0	0	0	0	0	0	0	0	0	0	0	1	1	1	1	1	1	1		

**11. Interface Timing**

**11.1 Input Signal Characteristics**

**11.1.1.AC Electrical Characteristics**

Parameter	Symbol	Values			Unit	Remark
		Min.	Typ.	Max.		
Clock frequency	$R_{xFCLK}$	40.8	51.2	67.2	MHz	
Input data skew margin	$T_{RSKM}$	500	-	-	ps	
Clock high time	$T_{LVCH}$	-	$4/(7 * R_{xFCLK})$	-	ns	
Clock low time	$T_{LVCL}$	-	$3/(7 * R_{xFCLK})$	-	ns	

**11.1.2. Input Clock and Data Timing Diagram**

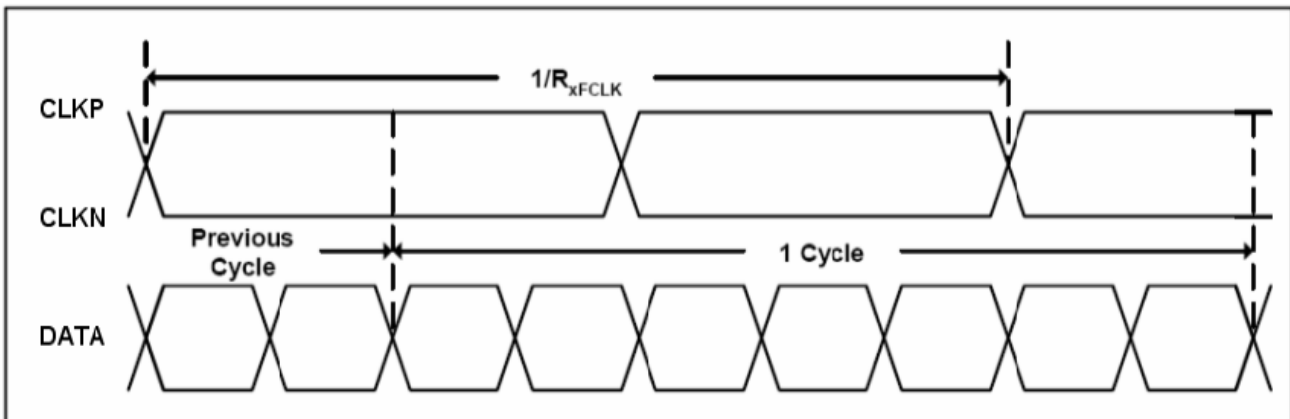

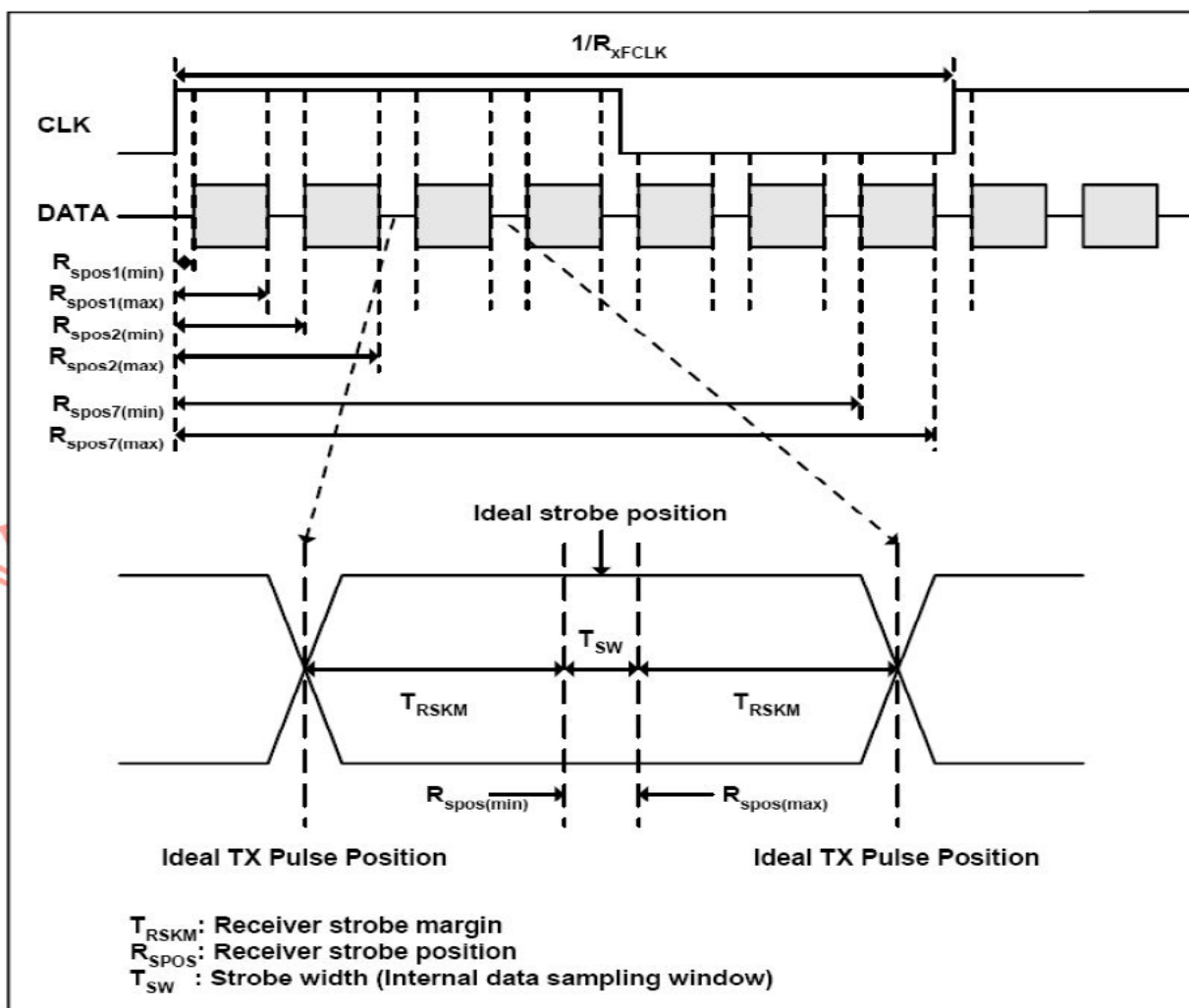

**11.1.3. Timing**

Item	Symbol	Values			Unit	Remark
		Min.	Typ.	Max.		
Clock Frequency	fclk	40.8	51.2	67.2	MHz	Frame rate =60Hz
Horizontal display area	thd	1024			DCLK	
HS period time	th	1114	1344	1400	DCLK	
HS Blanking	thb	90	320	376	DCLK	
Vertical display area	tvd	600			H	
VS period time	tv	610	635	800	H	
VS Blanking	thb	10	35	200	H	



**11.1.4. Data Input Format**

**6bit LVDS input**

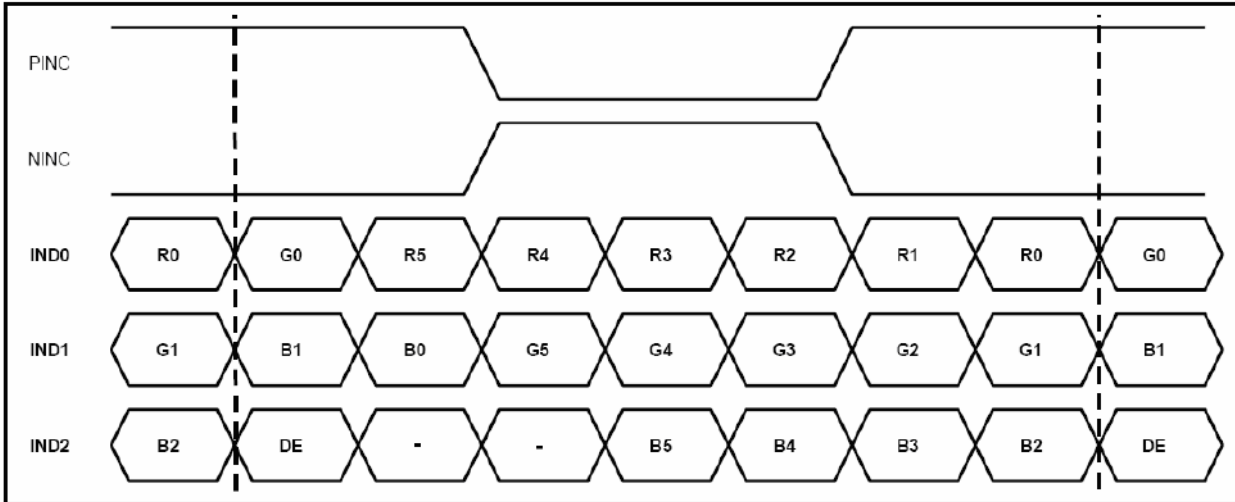

**8bit LVDS input**

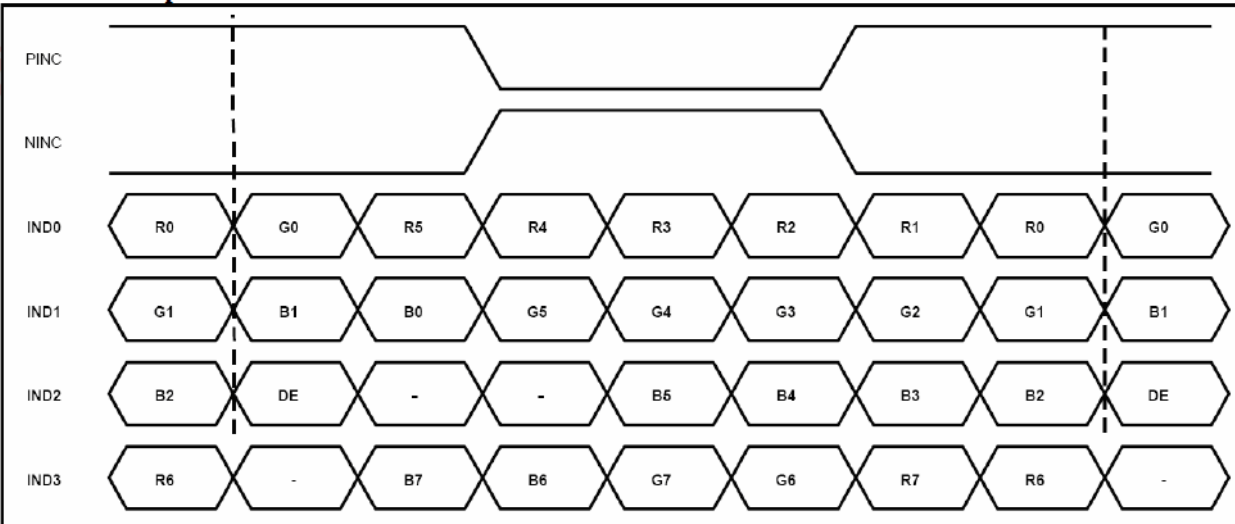

Note: Support DE timing mode only, SYNC mode not supported.

**11.2 Power Sequence**

**a. Power on:**

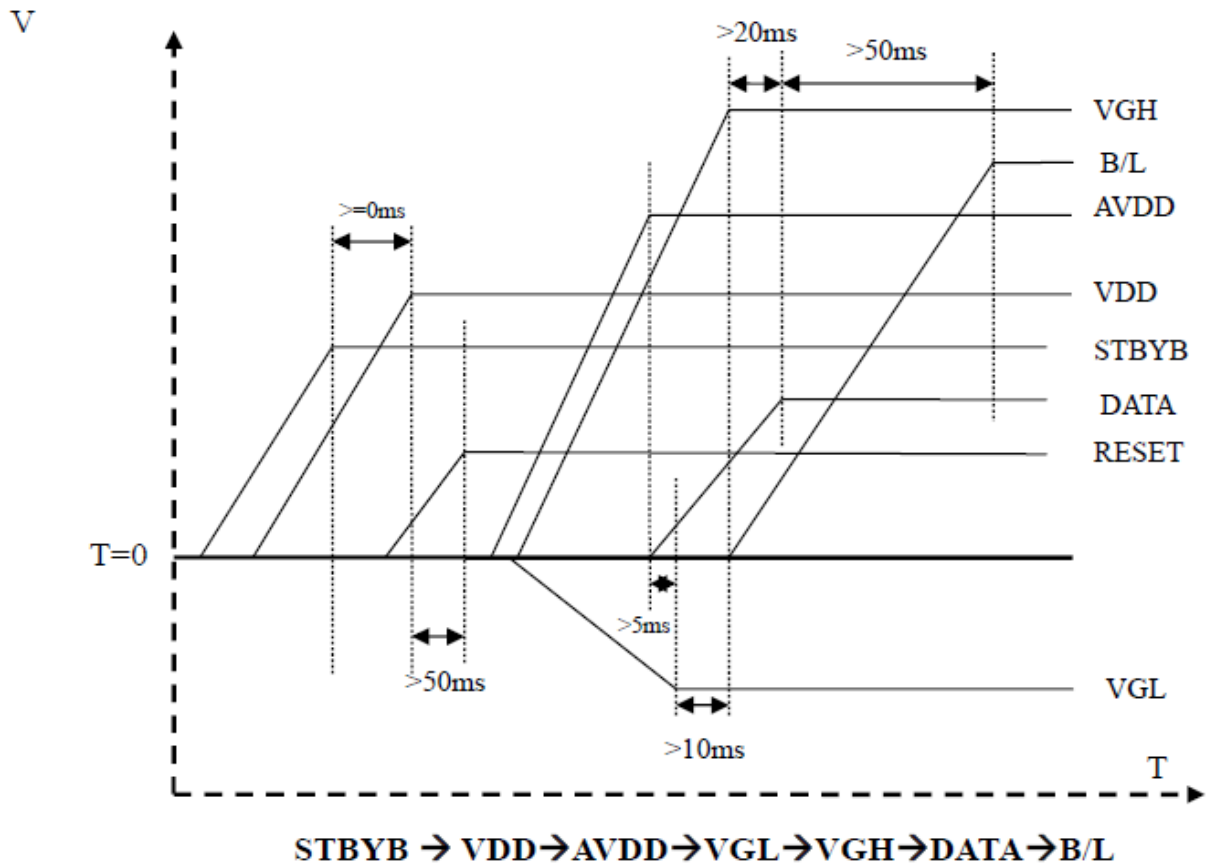

**b. Power off:**

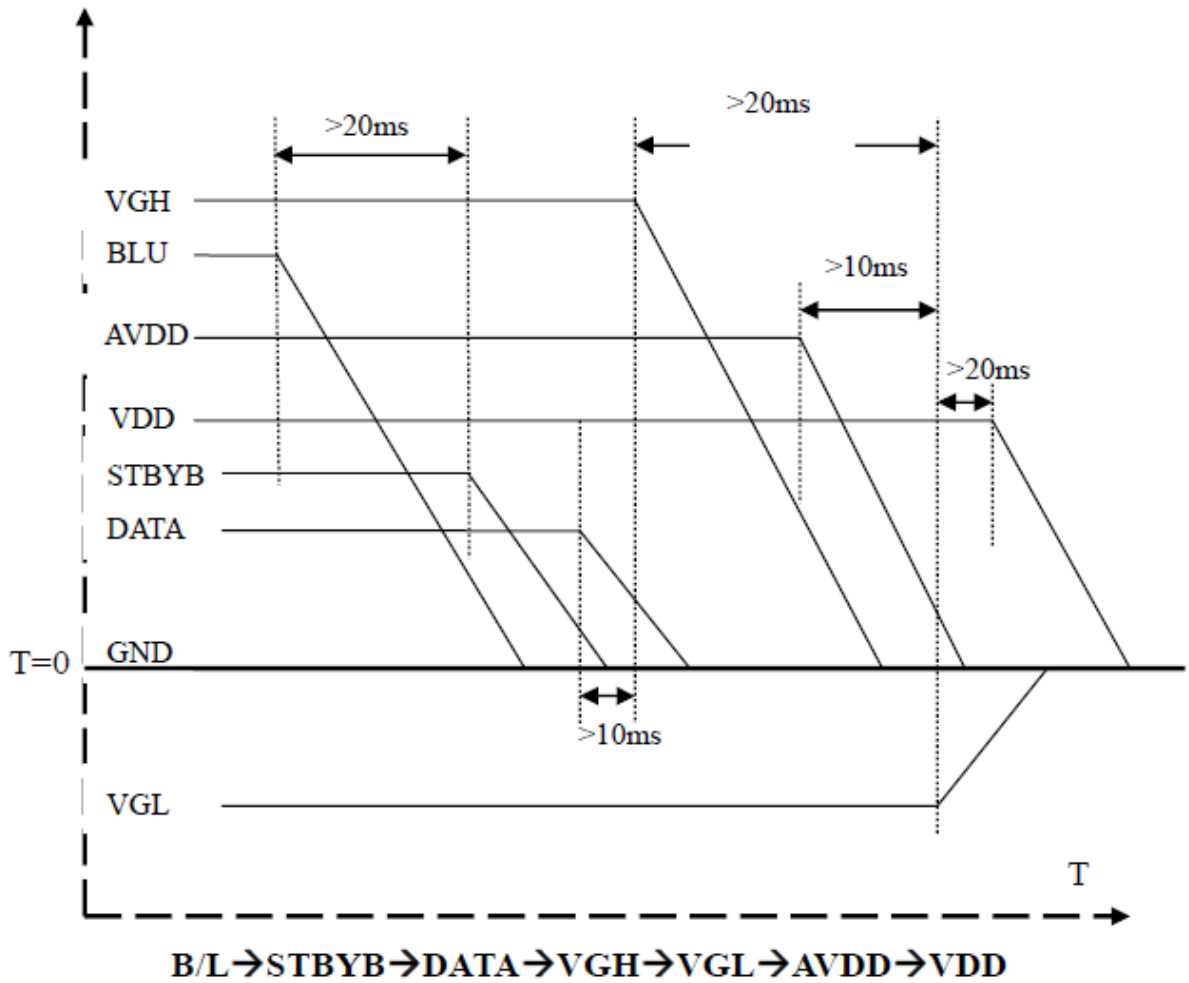

### 11.3 Timing Requirement of Improved Projected Capacitive Touch

#### 11.3.1 I2C Data Transfer Format

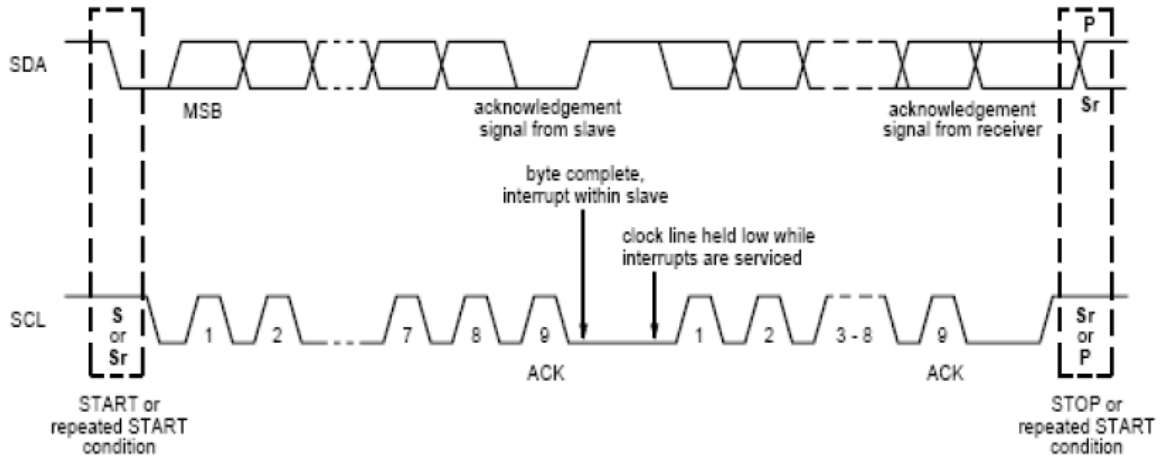

Mnemonics	Description
S	I <sup>2</sup> C Start or I <sup>2</sup> C Restart
A[6:0]	Slave Address = 7'b0111000
W	1'b0: Write
R	1'b1: Read
C	ACK
P	STOP: the indicate the end of a packet (if this bit is missing, S will indicate the end of the current packet and the beginning of the next packet)

#### Write N bytes to I2C slave

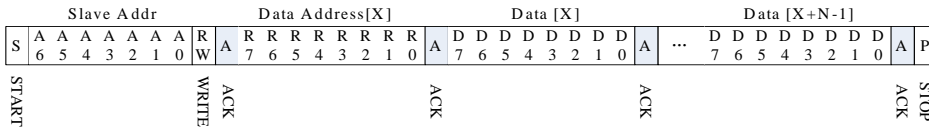

#### Set Data Address

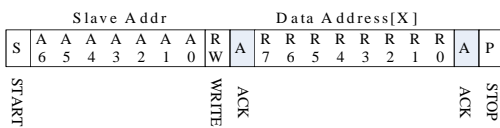

#### Read X bytes from I2C Slave

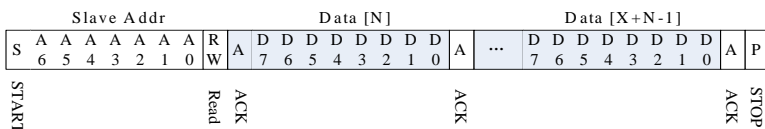

### 11.3.2 I2C Timing Characteristics

(Ta=25±2°C)

Parameter	Min	Max	Unit
SCL frequency	-	400	kHz
Bus free time between a STOP and START condition	4.7	-	μs
Hold time (repeated) START condition	4.0	-	μs
Data setup time	250	-	ns
Setup time for a repeated START condition	4.7	-	μs
Setup time for STOP condition	4.0	-	μs

### 11.3.3 Interrupt Trigger Mode

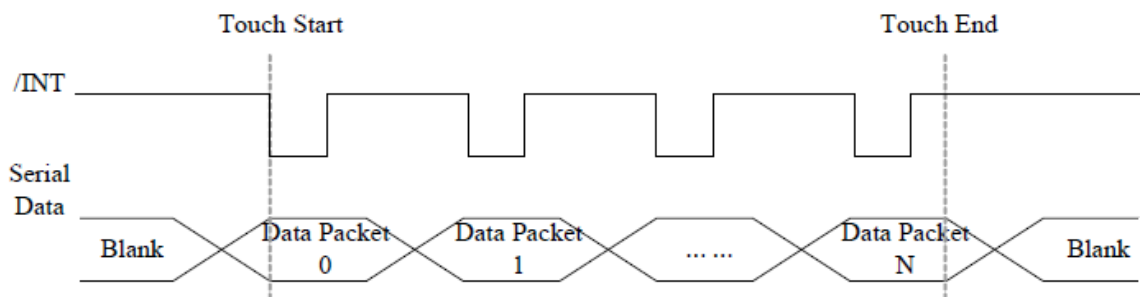

### 11.3.4 I2C Operating Mode Register Map

Address	Name	Bit 7	Bit 6	Bit 5	Bit 4	Bit 3	Bit 2	Bit 1	Bit 0	Host Access
Op,00h	DEVICE_MODE	Device Mode[2:0]								RW
Op,01h	Reserved									R
Op,02h	TD_STATUS					Number of touch points[3:0]				R
Op,03h	TOUCH1_YH	1 <sup>st</sup> Event Flag					1 <sup>st</sup> Touch Y Position[11:8]			R
Op,04h	TOUCH1_YL	1 <sup>st</sup> Touch Y Position[7:0]								R
Op,05h	TOUCH1_XH	1 <sup>st</sup> Touch ID[3:0]			1 <sup>st</sup> Touch X Position[11:8]				R	
Op,06h	TOUCH1_XL	1 <sup>st</sup> Touch X Position[7:0]								R
Op,07h	Reserved									R
Op,08h	Reserved									R
Op,09h	TOUCH2_YH	2 <sup>nd</sup> Event					2 <sup>nd</sup> Touch			R

<b>EVERVISION</b>	<b>MODEL NO.</b>		<b>PAGE</b>
	VGG106004-6UFLWE	SPEC SAMPLE	22

		Flag		Y Position[11:8]	
Op,0Ah	TOUCH2_YL	2 <sup>nd</sup> touch Y Position[7:0]			R
Op,0Bh	TOUCH2_XH	2 <sup>nd</sup> Touch ID[3:0]		2 <sup>nd</sup> Touch X Position[11:8]	R
Op,0Ch	TOUCH2_XL	2 <sup>nd</sup> Touch X Position[7:0]			R
Op,0Dh	Reserved				R
Op,0Eh	Reserved				R
Op,0Fh	TOUCH3_YH	3 <sup>rd</sup> Event Flag		3 <sup>rd</sup> Touch Y Position[11:8]	R
Op,10h	TOUCH3_YL	3 <sup>rd</sup> Touch Y Position[7:0]			R
Op,11h	TOUCH3_XH	3 <sup>rd</sup> Touch ID[3:0]		3 <sup>rd</sup> Touch X Position[11:8]	R
Op,12h	TOUCH3_XL	3 <sup>rd</sup> Touch X Position[7:0]			R
Op,13h	Reserved				R
Op,14h	Reserved				R
Op,15h	TOUCH4_YH	4 <sup>th</sup> Event Flag		4 <sup>th</sup> Touch Y Position[11:8]	R
Op,16h	TOUCH4_YL	4 <sup>th</sup> Touch Y Position[7:0]			R
Op,17h	TOUCH4_XH	4 <sup>th</sup> Touch ID[3:0]		4 <sup>th</sup> Touch X Position[11:8]	R
Op,18h	TOUCH4_XL	4 <sup>th</sup> Touch X Position[7:0]			R
Op,19h	Reserved				R
Op,1Ah	Reserved				R
Op,1Bh	TOUCH5_YH	5 <sup>th</sup> Event Flag		5 <sup>th</sup> Touch Y Position[11:8]	R
Op,1Ch	TOUCH5_YL	5 <sup>th</sup> Touch Y Position[7:0]			R
Op,1Dh	TOUCH5_XH	5 <sup>th</sup> Touch ID[3:0]		5 <sup>th</sup> Touch X Position[11:8]	R
Op,1Eh	TOUCH5_XL	5 <sup>th</sup> Touch X Position[7:0]			R
Op,1Fh	Reserved				R
Op,20h	Reserved				R
Op,21h	TOUCH6_YH	6 <sup>th</sup> Event Flag		6 <sup>th</sup> Touch Y Position[11:8]	R
Op,22h	TOUCH6_YL	6 <sup>th</sup> Touch Y Position[7:0]			R
Op,23h	TOUCH6_XH	6 <sup>th</sup> Touch ID[3:0]		6 <sup>th</sup> Touch X Position[11:8]	R
Op,24h	TOUCH6_XL	6 <sup>th</sup> Touch X Position[7:0]			R
Op,25h	Reserved				R

<b>EVERVISION</b>	<b>MODEL NO.</b>		<b>PAGE</b>
	VGG106004-6UFLWE	SPEC SAMPLE	23

Op,26h	Reserved			R
Op,27h	TOUCH7_YH	7 <sup>th</sup> Event Flag	7 <sup>th</sup> Touch Y Position[11:8]	R
Op,28h	TOUCH7_YL	7 <sup>th</sup> Touch Y Position[7:0]		R
Op,29h	TOUCH7_XH	7 <sup>th</sup> Touch ID[3:0]	7 <sup>th</sup> Touch X Position[11:8]	R
Op,2Ah	TOUCH7_XL	7 <sup>th</sup> Touch X Position[7:0]		R
Op,2Bh	Reserved			R
Op,2Ch	Reserved			R
Op,2Dh	TOUCH8_YH	8 <sup>th</sup> Event Flag	8 <sup>th</sup> Touch Y Position[11:8]	R
Op,2Eh	TOUCH8_YL	8 <sup>th</sup> Touch Y Position[7:0]		R
Op,2Fh	TOUCH8_XH	8 <sup>th</sup> Touch ID[3:0]	8 <sup>th</sup> Touch X Position[11:8]	R
Op,30h	TOUCH8_XL	8 <sup>th</sup> Touch X Position[7:0]		R
Op,31h	Reserved			R
Op,32h	Reserved			R
Op,33h	TOUCH9_YH	9 <sup>th</sup> Event Flag	9 <sup>th</sup> Touch Y Position[11:8]	R
Op,34h	TOUCH9_YL	9 <sup>th</sup> Touch Y Position[7:0]		R
Op,35h	TOUCH9_XH	9 <sup>th</sup> Touch ID[3:0]	9 <sup>th</sup> Touch X Position[11:8]	R
Op,36h	TOUCH9_XL	9 <sup>th</sup> Touch X Position[7:0]		R
Op,37h	Reserved			R
Op,38h	Reserved			R
Op,39h	TOUCH10_YH	10 <sup>th</sup> Event Flag	10 <sup>th</sup> Touch Y Position[11:8]	R
Op,3Ah	TOUCH10_YL	10 <sup>th</sup> Touch Y Position[7:0]		R
Op,3Bh	TOUCH10_XH	10 <sup>th</sup> Touch ID[3:0]	10 <sup>th</sup> Touch X Position[11:8]	R
Op,3Ch	TOUCH10_XL	10 <sup>th</sup> Touch X Position[7:0]		R
Op,3Dh	Reserved			R
Op,3Eh	Reserved			R

### 11.3.5 DEVICE\_MODE

This register is the device mode register, configure it to determine the current mode of the chip.

Address	Bit Address	Register Name	Description
Op,00h	6:4	Device Mode [2:0]	000b Normal operating Mode 001b System Information Mode (Reserved) 100b Test Mode – read raw data (Reserved)

### 11.3.6 TD\_STATUS

This register is the Touch Data status register.

Address	Bit Address	Register Name	Description
Op,02h	3:0	Number of touch points[3:0]	How many points detected. 1-10 is valid.

### 11.3.7 TOUCHn\_YH (n:1-10)

This register describes MSB of the Y coordinate of the nth touch point and the corresponding event flag.

Address	Bit Address	Register Name	Description
Op,03h ~ Op,39h	7:6	Event Flag	00b: Put Down 01b: Put Up 10b: Contact 11b: No event
	5:4		Reserved
	3:0	Touch Y Position [11:8]	MSB of Touch Y Position in pixels



### 11.3.8 TOUCHn\_YL (n:1-10)

This register describes LSB of the Y coordinate of the nth touch point.

Address	Bit Address	Register Name	Description
Op,04h ~ Op,3Ah	7:0	Touch Y Position [7:0]	LSB of the Touch Y Position in pixels

### 11.3.9 TOUCHn\_XH (n:1-10)

This register describes MSB of the X coordinate of the nth touch point and corresponding touch ID.

Address	Bit Address	Register Name	Description
Op,05h ~ Op,3Bh	7:4  3:0	Touch ID[3:0]  Touch X Position [11:8]	Touch ID of Touch Point  MSB of Touch X Position in pixels

### 11.3.10 TOUCHn\_XL (n:1-10)

This register describes LSB of the X coordinate of the nth touch point.

Address	Bit Address	Register Name	Description
Op,06h ~ Op,3Ch	7:0	Touch X Position [7:0]	LSB of The Touch X Position in pixels

## 11.4 POWER ON/Reset Sequence

Reset should be pulled down to be low before powering on and powering down. I2C shouldn't be used by other devices during Reset time after VDD powering on (Trtp). INT signal will be sent to the host after initializing all parameters and then start to report points to the host. If Power is down, the voltage of supply must be below 0.3V and Tpd is more than 1ms.

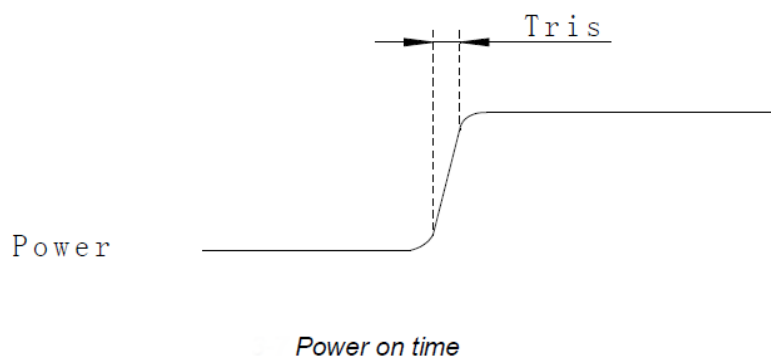

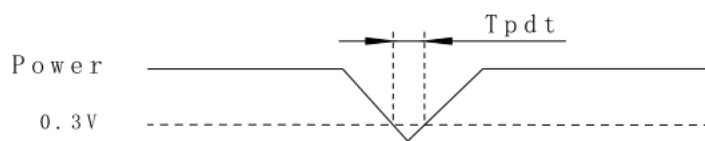

*Power Cycle requirement*

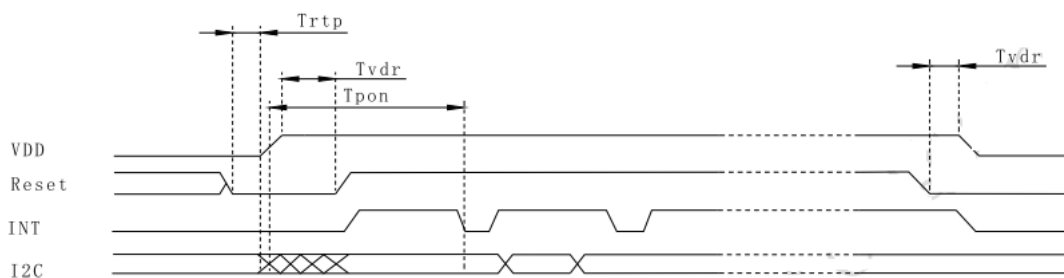

*Power on Sequence*

Reset time must be enough to guarantee reliable reset, the time of starting to report point after resetting approach to the time of starting to report point after powering on.

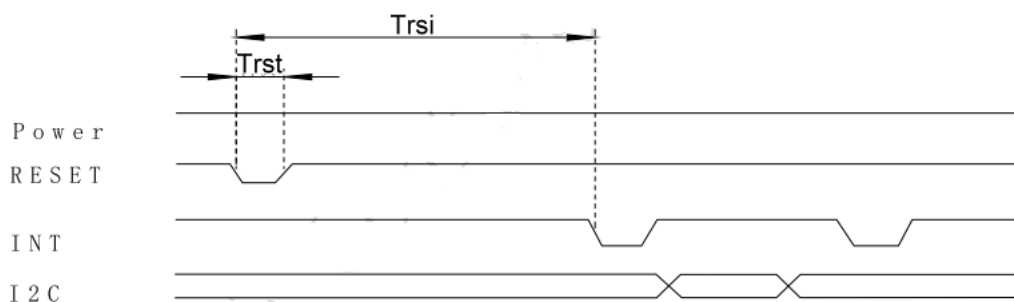

*Reset Sequence*

**Power on/Reset Sequence Parameters**

Parameter	Description	Min	Max	Units
Tris	Rise time from 0.1VDD to 0.9VDD	--	5	ms
Tpdt	Time of the voltage of supply being below 0.3V	5	--	ms
Trtp	Time of resetting to be low before powering on	100	--	$\mu$ s
Tpon	Time of starting to report point after powering on	--	200	ms
Tvd r	Reset time after VDD powering on	1	--	ms
Trsi	Time of starting to report point after resetting	--	200	ms
Trst	Reset time	1	--	ms

<b>EVERVISION</b>	<b>MODEL NO.</b>		<b>PAGE</b>
	VGG106004-6UFLWE	SPEC SAMPLE	27

## 12. Optical Characteristics

The optical characteristics should be measured in a dark environment ( $\leq 1$  lux) or equivalent state with the methods shown in Note (4).

Item		Symbol	Conditions	Min.	Typ.	Max.	Unit	Note
Contrast Ratio		CR	$\theta_x=0^\circ, \theta_y=0^\circ$ Viewing Normal Angle	560	(700)	-	-	(2)
Response Time		$T_R$		-	4	8	ms	(3)
		$T_F$		-	12	24	ms	
Luminance(Center)		Y		390	(440)	-	cd/m <sup>2</sup>	(4)
Brightness uniformity		BUNI		-	(70)	-	%	(5)
Color Chromaticity	Red	Rx	Viewing Normal Angle	0.576	0.626	0.676	-	(1),(4)
		Ry		0.275	0.325	0.375	-	
	Green	Gx		0.278	0.328	0.378	-	
		Gy		0.498	0.548	0.598	-	
	Blue	Bx		0.086	0.136	0.186	-	
		By		0.091	0.141	0.191	-	
	White	Wx		0.260	0.310	0.360	-	
		Wy		0.280	0.330	0.380	-	
Viewing Angle	Horizontal	$\theta_{x+}$	CR $\geq$ 10	60	(70)	-	deg.	(1),(4)
		$\theta_{x-}$		60	(70)	-		
	Vertical	$\theta_{y+}$		60	(70)	-		
		$\theta_{y-}$		50	(60)	-		

Note (1) Definition of Viewing Angle ( $\theta_x, \theta_y$ ):

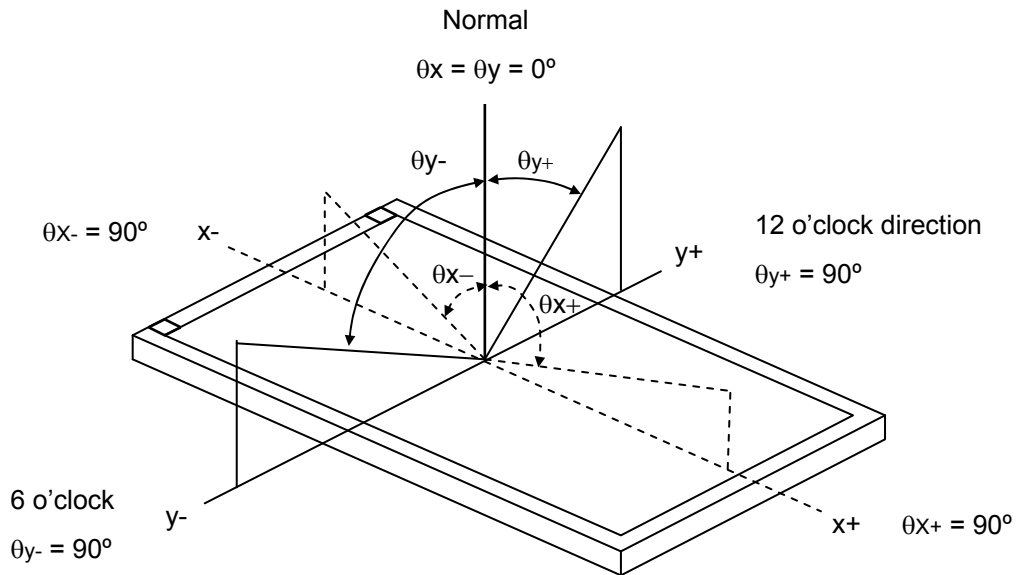

Note (2) Definition of Contrast Ratio (CR):

$$\text{Contrast ratio (CR)} = \frac{\text{Luminance measured when LCD on the "White" state}}{\text{Luminance measured when LCD on the "Black" state}}$$

Note (3) Definition of Response Time ( $T_R, T_F$ ):

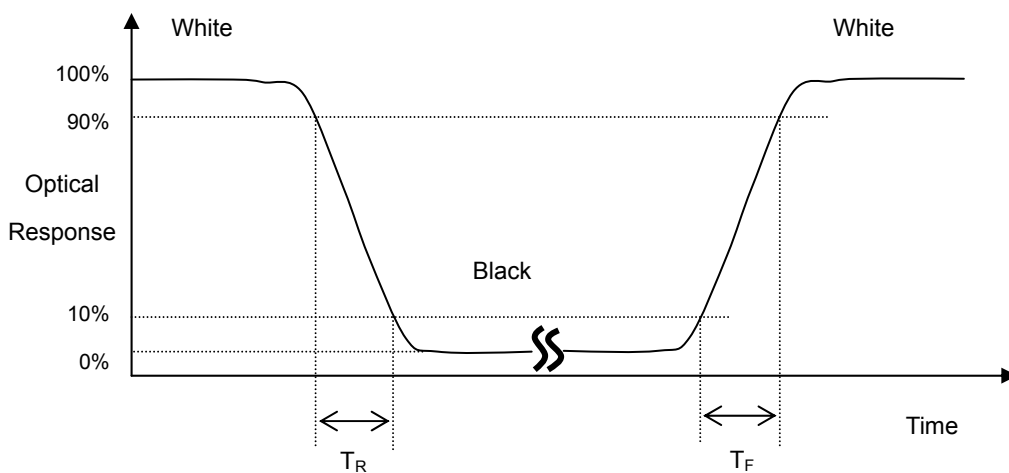

**Note (4) Measurement Set-Up:**

The LCD module should be stabilized at a given temperature for 30 minutes to avoid abrupt temperature change during measuring. In order to stabilize the luminance, the measurement should be executed after lighting Backlight for 30 minutes in a dark room or equivalent condition.

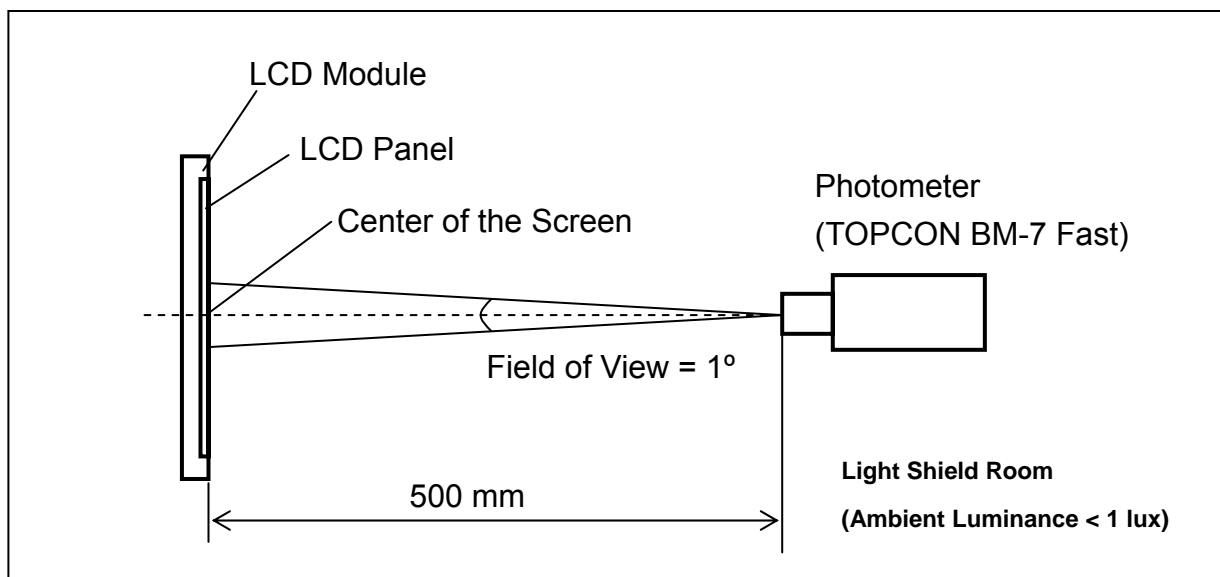

**Note (5) Definition of brightness uniformity**

Brightness uniformity=(Min Luminance of 9 points)/(Max Luminance of 9 points)×100%

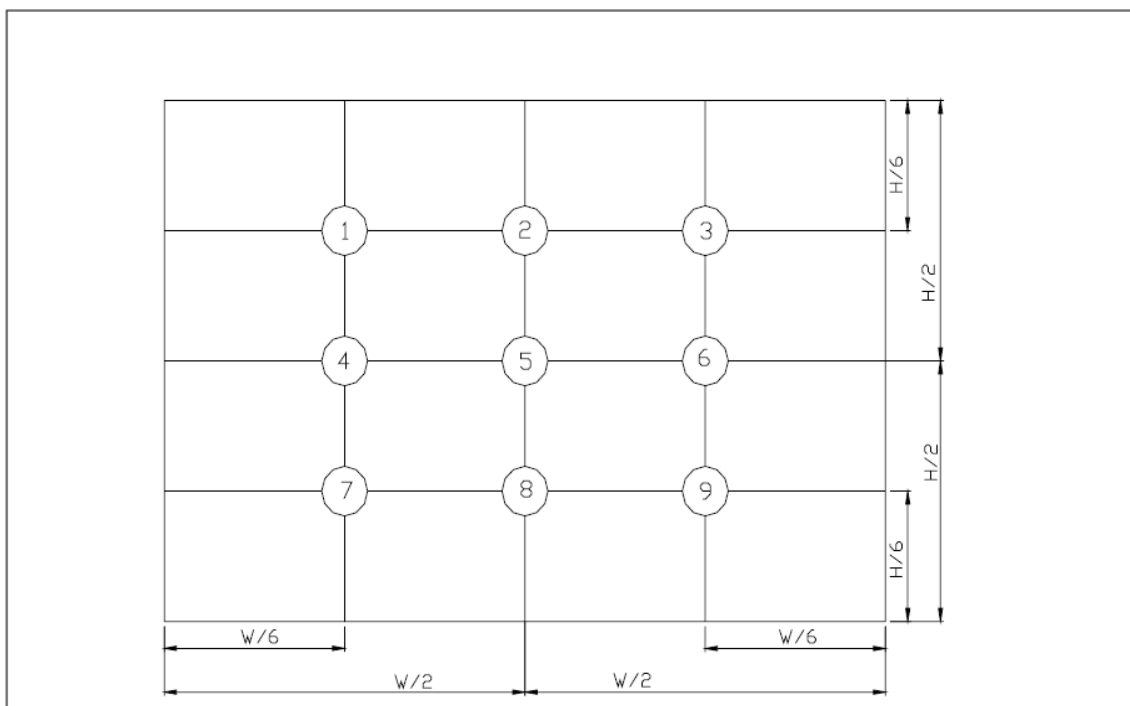

( 單位 : mm )

<b>EVERVISION</b>	<b>MODEL NO.</b>		<b>PAGE</b>
	VGG106004-6UFLWE	SPEC SAMPLE	30

### 13. Reliability Test

Test Item	Test Conditions	Notes
<b>High temperature Operation</b>	70±3℃ ,T=240hrs	
<b>Low temperature Operation</b>	-20±3℃ ,T=240hrs	
<b>High Temperature Storage</b>	80±3℃ ,T=240hrs	1,2
<b>Low Temperature Storage</b>	-30±3℃ ,T=240hrs	1,2
<b>Humidity Test</b>	40℃ ,Humidity 90% ,240hrs	1,2
<b>Thermal Shock Test</b>	-30℃,30min~70℃,30min (200 cycle)	1,2
<b>Vibration Test(Packing)</b>	Sweep frequency 10~55~10HZ/min Amplitude:0.75mm Test direction:X,Y,Z/3 axis Duration 30min/each axis	2
<b>Static Electricity</b>	150Pf 330ohm ±8KV, 10time air discharge ±4KV, 10time connect discharge	

Note 1: Temperature is the ambient temperature of samples.

Note 2: Before cosmetic and function test, the product must have enough recovery time, at least 2 hours at room temperature.

**14. Packaging**

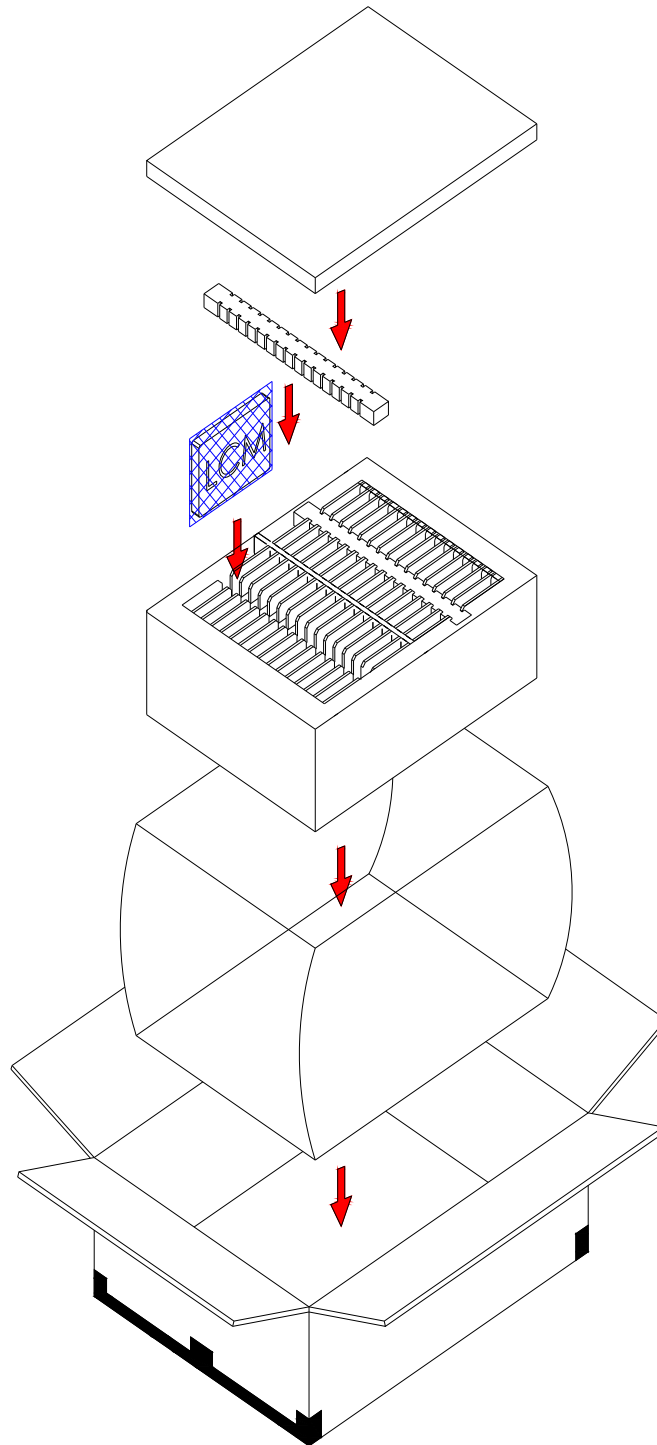

**PARTS LIST**

	ITEM	SIZE(LxWxH) unit : mm	MATERIAL	Q.T.Y	NOTE
1	PRODUCT	165.0x104.0x5.05		60	
2	EXTERNAL BOX	400.0x330.0x150.0	CARTON	1	

<b>EVERVISION</b>	<b>MODEL NO.</b>		<b>PAGE</b>
	VGG106004-6UFLWE	SPEC SAMPLE	32

## **15. Precautions**

### **15.1 Assembly and Handling Precautions**

- (1) Do not apply rough force such as bending or twisting to the module during assembly.
- (2) It's recommended to assemble or to install a module into the user's system in clean working areas. The dust and oil may cause electrical short or worsen the polarizer.
- (3) Don't apply pressure or impulse to the module to prevent the damage of LCD panel and Backlight.
- (4) Always follow the correct power-on sequence when the LCD module is turned on. This can prevent the damage and latch-up of the CMOS LSI chips.
- (5) Do not plug in or pull out the I/F connector while the module is in operation.
- (6) Do not disassemble the module.
- (7) Use a soft dry cloth without chemicals for cleaning, because the surface of polarizer is very soft and easily scratched.
- (8) Moisture can easily penetrate into LCD module and may cause the damage during operation.
- (9) High temperature or humidity may deteriorate the performance of LCD module. Please store LCD module in the specified storage conditions.
- (10) When ambient temperature is lower than 10°C, the display quality might be reduced. For example, the response time will become slow.

### **15.2 Safety Precautions**

- (1) If the liquid crystal material leaks from the panel, it should be kept away from the eyes or mouth. In case of contact with hands, skin or clothes, it has to be washed away thoroughly with soap.
- (2) After the module's end of life, it is not harmful in case of normal operation and storage.

### **15.3 Terms of Warrant**

- (1) Acceptance inspection period  
The period is within one month after the arrival of contracted commodity at the buyer's factory site.
- (2) Applicable warrant period  
The period is within twelve months since the date of shipping out under normal using and storage conditions.



<b>EVERVISION</b>	<b>MODEL NO.</b>		<b>PAGE</b>
	VGG106004-6UFLWE	SPEC SAMPLE	33

#### **15.4 Caution**

This Evervision LCD module has been specifically designed for use only in electronic devices in the areas of audio control, office automation, industrial control, home appliances, etc. The modules should not be used in applications where module failure could result in physical harm or loss of life, and Evervision expressly disclaims any and all liability relating in any way to the use of the module in such applications.

**16.Outline Drawing**

NOTE: UNSPECIFIED TOLERANCES IS  $\pm 0.3\text{mm}$

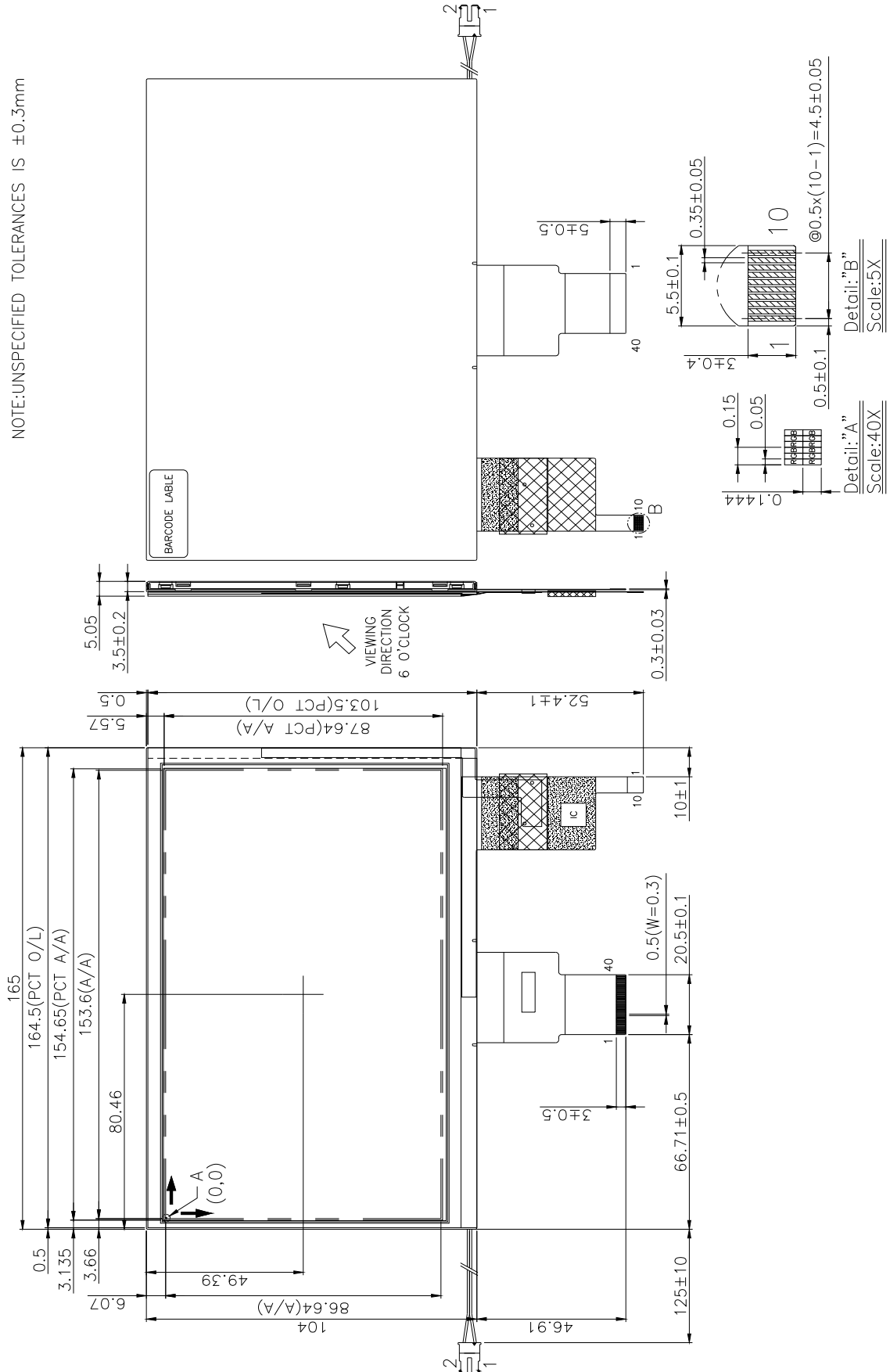

**17. Definition of Labels**

The bar code nameplate is pasted on each module as illustration, and its definitions are as following explanation.



(a) Module Name : VGG106004-6UFLWE

(b) Serial ID :

A B C D    E F G    H    IJKL

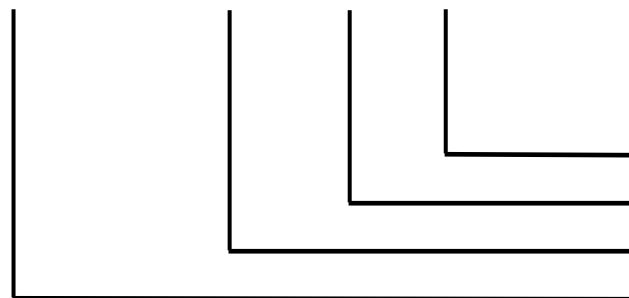

Serial No.  
Factory Code  
Manufactured Date  
Screen Size

Serial ID includes the information as below :

(a) Screen size (Diagonal) : Inch Code (ABCD)

3.5" → 0350

10.4" → 1040

(b) Manufactured Date : Year, Month, Day (EFG)

Year (E)

Year	2000	2001	2002	2003	2004	2005	2006	2007	2008	2009
Mark	0	1	2	3	4	5	6	7	8	9
Year	2010	2011	2012	2013	2014	2015	2016	2017	2018	2019
Mark	A	B	C	D	E	F	G	H	I	J

<b>EVERVISION</b>	<b>MODEL NO.</b>		<b>PAGE</b>
	VGG106004-6UFLWE	SPEC SAMPLE	36

Month (F)

Month	Jan.	Feb.	Mar.	Apr.	May	Jun.	Jul.	Aug.	Sep.	Oct.	Nov.	Dec.
Mark	1	2	3	4	5	6	7	8	9	A	B	C

Day (G)

Day	1	2	3	4	5	6	7	8	9	10	11	12	13	14	15	16
Mark	1	2	3	4	5	6	7	8	9	A	B	C	D	E	F	G
Day	17	18	19	20	21	22	23	24	25	26	27	28	29	30	31	
Mark	H	I	J	K	L	M	N	O	P	Q	R	S	T	U	V	

(c) Factory Code (H) :

For EVERVISION internal use.

(d) Serial No. (IJKL) :

Manufacturing sequence of product, for example : 0001~9999.

<b>EVERVISION</b>	<b>MODEL NO.</b>		<b>PAGE</b>
	VGG106004-6UFLWE	SPEC SAMPLE	37

## 18. Incoming Inspection Standards

### 1.0 Purpose:

This incoming inspection standards shall be apply to TFT-LCD Module

### 2.0: Visual inspection criteria

#### 2.1. Inspection condition is as followings

- Viewing distance is approximately 30cm
- Viewing angle is referred to the CAS
- Ambient temperature is in the room temperature
- Ambient illumination is 300 +/-50 LUX

Defect type		Criteria	
Electrical defect	Area (Note 2)	I	O
	Bright dots(Note 3)	N≤0	N≤2
	Dark dots (Note 4)	N≤2	N≤4
	Bright dot-2Adjacent(note5)	N≤0	
	Dark dot-2Adjacent(note6)	N≤0	
	Dark or bright dots-3 and more adjacent(note6)	N≤0	
	Total bright and dark dots	N≤4	
	Minimum distance between bright dots	5mm	
	Minimum distance between dark dots	5mm	
	Minimum distance between bright and bright dots	5mm	
Visual defect	Foreign material	Circular foreign material: dark/bright sport	Visible under:ND5% 1:D≤0.15mm:No count 2:0.15mm<D≤0.5mm,N≤4 3:D>0.5mm:Not allowable
		Linear foreign material: bright or dark line	Invisible under ND5% 0.1mm<W≤0.5mm, 0.3mm<L≤1.5mm,N≤4 Visible under ND5% 0.05mm≤w≤0.1mm, 0.3mm≤L≤0.7mm,N≤4
	Polarizer	Linear scratch	1:BM:No Count 2:Pixel area 0.05mm≤w≤0.2mm, 1.0mm≤L≤5.0mm,N≤4
		Bubble peeling	1:BM:No Count 2:Pixel area 0.15mm≤D<0.5mm,N≤4
	Mura & leak	ND5%	

D: diameter, N: number, W: horizontal width, L: vertical height

<b>EVERVISION</b>	<b>MODEL NO.</b>		<b>PAGE</b>
	VGG106004-6UFLWE	SPEC SAMPLE	39

2.2: others

Note(1)

- a. every dot herein means sub-pixel(each red ,green ,blue color)
- b. damaged less than half size of sub-pixel is not counted as defect
- c. extraneous substances which can be wiped out are not considered as defect
- d. defects which is on the black(outside of active area) ore not considered as defect.

Note (2) definition of area.

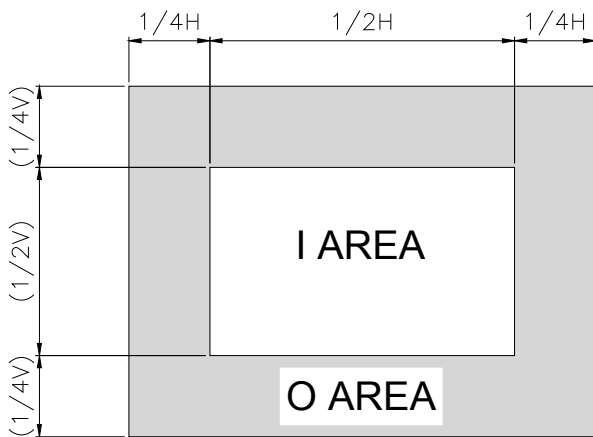

Note(3) Bright dot defect definition

Bright area is more than 50% of one dot. All bright dot defect must be visible through 5% ND filter

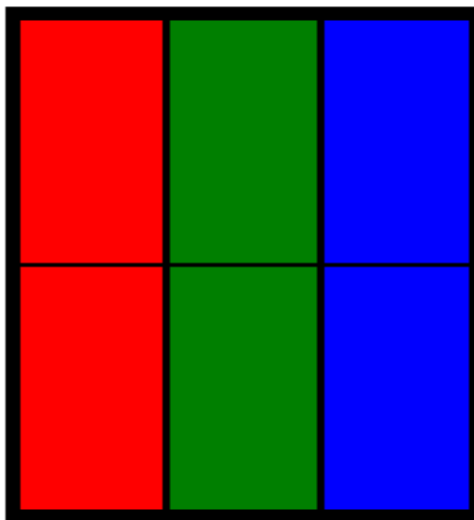

A diagram of a pixel.

One dot refers to one upper and one lower R, G, or B combined. (The middle BM, or black mask, is thinner, while the top and bottom BM are thicker.)

<b>EVERVISION</b>	<b>MODEL NO.</b>		<b>PAGE</b>
	VGG106004-6UFLWE	SPEC SAMPLE	40

Note(4) Dark dot defect definition

-dark area is more than 50% of one dot. All bright dot defect must be visible through 5% ND filter



Note (5) bright dot defect description

-two adjacent

Type 1



Note (6) Dark dot defect description

-two adjacent

Type1



Note(7) dark dot defect description

-three adjacent



<b>EVERVISION</b>	<b>MODEL NO.</b>		<b>PAGE</b>
	VGG106004-6UFLWE	SPEC SAMPLE	41

Type1



Type2



type3



type4



Note(8) minimum distance between dot defects

Bright dot to bright dot

The pitch is less than 5mm.

Dark dot to dark dot

The pitch is less than 5mm.

Bright dot to dark dot

The pitch is less than 5mm.

Note(9) "Average diameter" description

Average diameter=(a+b)/2

The defect that are not defined above and considered to be problem shall be reviewed and discussed by both parties

Note(10) Bright dot, mura and leak are defined through transmission ND Filter as following.

Form the eyes to the TFT LCM surface is 30cm.

**Incoming Inspection Touch Panel**

Circular Defects  
 Linear Defects  
 Scratch  
 Air Bubble  
 Crack

(1) Circular Defects

$$\phi = (L+W)/2$$

Diameter(mm)	Spec
$\phi \leq 0.25$	No quantity limit
$0.25 < \phi \leq 0.5$	Max 5 defect
$0.5 < \phi$	Reject

(2) Linear Defects



Length	Width	Acceptable
$12.0 \geq L$	$0.06 \geq W$	Accept
$12.0 \geq L$	$0.08 \geq W$	Max 5 defect
$L > 12.0$	$W > 0.08$	Reject

The Min distance of defects must be above 15.0mm.

(3) Scratch

Length	Width	Acceptable
$12.0 \geq L$	$0.06 \geq W$	Accept
$12.0 \geq L$	$0.08 \geq W$	Max 5 defect
$L > 12.0$	$W > 0.08$	Reject

The Min distance of defects must be above 15.0mm.

(4) Air Bubble

Diameter(mm)	Spec
$\phi \leq 0.2$	No quantity limit
$0.2 < \phi \leq 0.6$	Max 5 defect

The Min distance of defects must be above 10.0mm.

(5) Crack

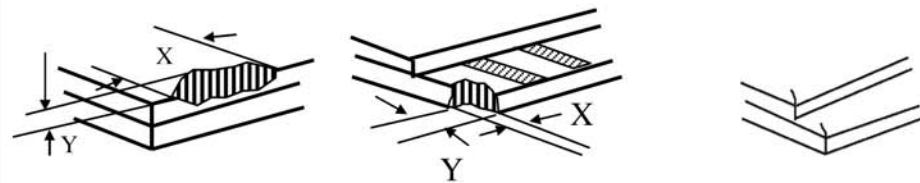

$Z \leq T, X \leq 1/8$  Sensor wide

$X \leq 3\text{mm}$  and  $Y \leq 1/3D$

Y: Did not enter the VA

(Accept)

(Accept)

(Reject)

Y:  
Long breakage

Z:  
Wide breakage

D:  
thickness  
breakage

T:  
single piece of  
glass thickness  
(Touch sensor  
single thickness)

VA:  
Touch control  
panel viewing  
area.

Sensor wide:  
the size of the  
long side of the  
touch panel.

<b>EVERVISION</b>	<b>MODEL NO.</b>		<b>PAGE</b>
	VGG106004-6UFLWE	SPEC SAMPLE	43

- (1)Don't give external shock.
- (2)Don't apply excessive force on the surface.
- (3)Liquid in LCD is hazardous substance. Must not lick and swallow. when the liquid is attach to your hand, skin, cloth etc. Wash it out thoroughly and immediately.
- (4)Don't operate it above the absolute maximum rating.
- (5)Don't disassemble the LCM.