

Thank you very much for purchasing Panasonic products. Please read this Instruction Manual carefully and thoroughly for the correct and optimum use of this product. Kindly keep this manual in a convenient place for quick reference.

WARNING

- This product is intended to detect objects. Do not use it to carry out safety control functions to prevent accidents.
- Never use this product as a sensing device for personnel protection.
- Do not look into the beam directly during operation.

1 CE marking

This product complies with the following standards and regulations.



- For the EU: EMC Directive 2014/30/EU
Contact for CE:
Panasonic Marketing Europe GmbH
Panasonic Testing Center
Winsbergring 15, 22525 Hamburg, Germany

2 Confirmation of packed content

- Sensor 1 pc.
- Laser warning label (JIS Standards, GB Standard) 1 set each
- FDA certification label 1 pc.
- Instruction Manual (Japanese, English) 1 pc. per language

3 Safe use of laser product

In order to prevent accidents caused by laser products and to protect the users, IEC, JIS and FDA established the following standards:

- IEC: IEC 60825-1-2007 (EN 60825-1-2007)
- JIS: JIS C 6802-2011
- FDA: PART 1040 (Performance standards for light-emitting products)

These standards classify laser products according to their level of hazard and provide safety measures for the respective classes.

Warning label and position



An English warning label is attached to this product.

4 Part description

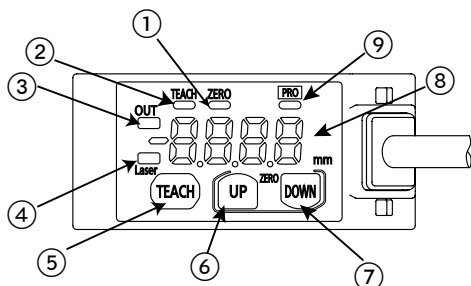

No.	Item
①	Zero set indicator (Yellow)
②	Teaching indicator (Yellow)
③	Output operation indicator (Orange)
④	Laser emission indicator (Green)
⑤	TEACH key
⑥	UP key
⑦	DOWN key
⑧	Digital indicator (Red)
⑨	PRO indicator (Yellow)

5 Mounting

When mounting this product, use M3 screws (prepare separately). Use a tightening torque of 0.5 N m for mounting.

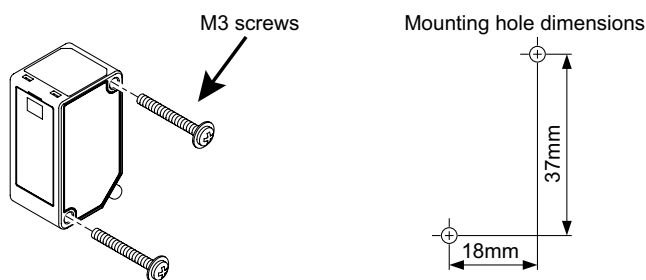

Mounting direction

- When performing measurements of moving objects with excessively different materials and colors, mount the product in the following directions to minimize measurement errors.

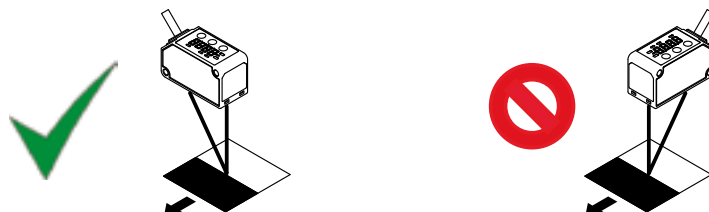

- When performing measurements of rotating objects, mount the product as follows. The effect of up/down deflection and position deviation can be minimized by mounting the sensor in the correct direction.

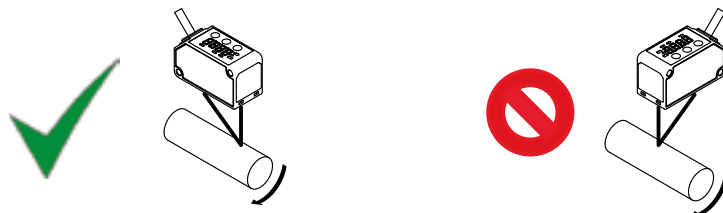

- When there is a step in the moving object, mount the product as follows. The effect of reflection deviation by the edges of the steps can be minimized by mounting the sensor in the correct direction.

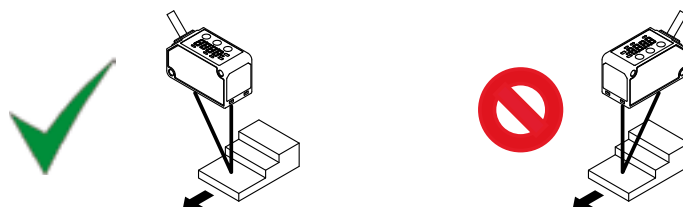

- When measuring in narrow locations or inside holes, mount the product so that optical path from the light emitting part to light-receiving part is not interrupted.

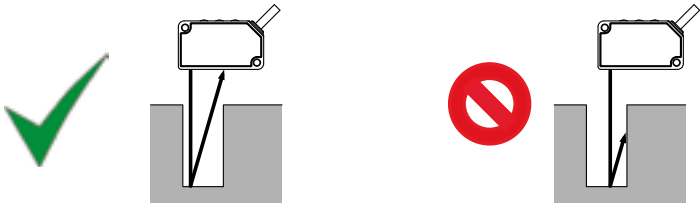

- Mount the sensor to a wall as follows, so that the multiple light reflections on the wall do not reach the light-receiving part. When the reflection factor on the wall is high, it is effective to use a dull black color.



6 I/O circuit diagrams

NPN output type

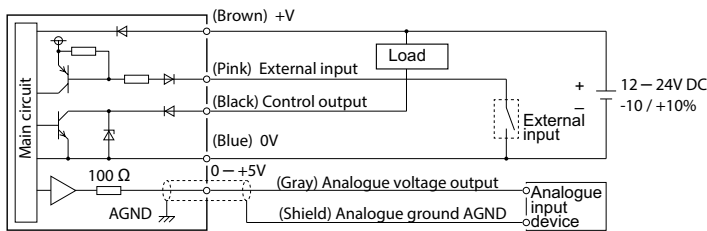

PNP output type

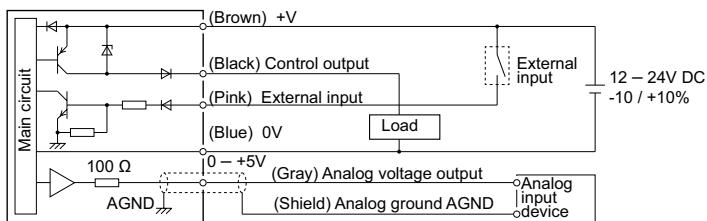

7 Teaching

2-point teaching

This method is the basic teaching method.

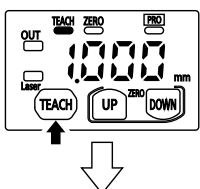
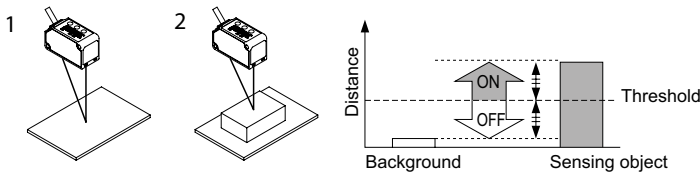

- Press the TEACH key when the background is present.

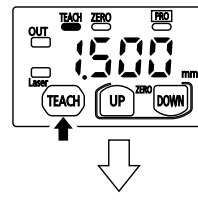

- Press the TEACH key when the sensing object is present.

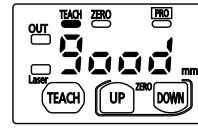

Stable sensing is possible.

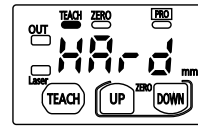

Stable sensing is not possible.

Limit teaching

This teaching method is recommended, if small objects or objects in the background exist.

When an object in the background is used as reference:

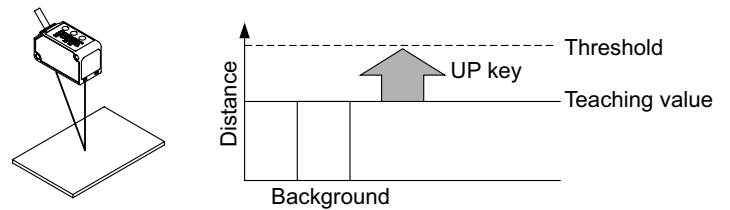

When a sensing object is used as reference:

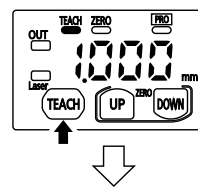
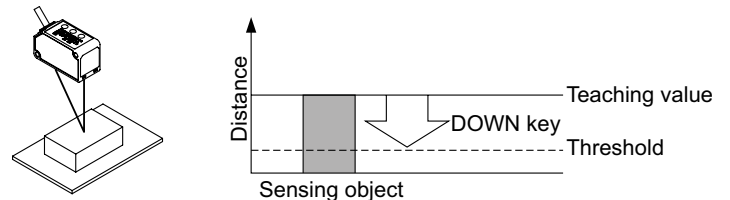

- Press the TEACH key when the background or the sensing object is present.

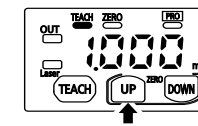

- When an object in the background is used as reference, press the UP key to set the threshold on the sensor side. When a sensing object is used as a reference, press the DOWN key to set the threshold on the sensing object side.

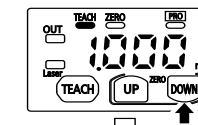

Automatic

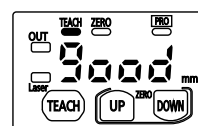

- Teaching is completed.

1-point teaching (window comparator mode)

This mode is used for setting the threshold range for the distance from the reference value of the sensing object by performing a 1-point teaching. This mode is used for sensing within the threshold range.

When performing the 1-point teaching (window comparator mode), preset "Window comparator mode 1" in the sensing output setting of the PRO mode. For the setting method, refer to section 12, "PRO mode setting."

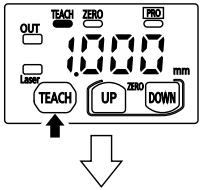
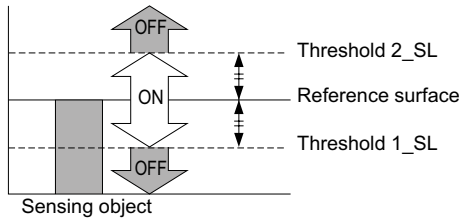

1. Press the TEACH key twice when the sensing object is present.

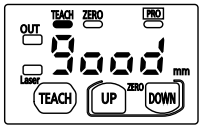

2. Teaching is completed.

2-point teaching (window comparator mode)

This method is used to set the threshold range by conduction the 2-point teaching.

When performing the 2-point teaching (window comparator mode), preset "Window comparator mode 2" in the sensing output setting of the PRO mode. For the setting refer to section 12, "PRO mode setting."

When conducting the teaching, use sensing objects (P-1 and P-2) whose distance are different from each other.

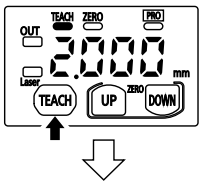
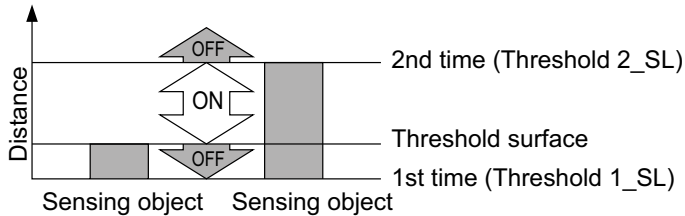

1. Press the TEACH key when the sensing object P-1 is present (1st time).

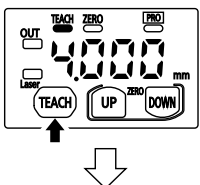

2. Press the TEACH key when the sensing object P-2 is present (second time).

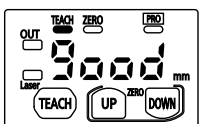

Stable sensing is possible.

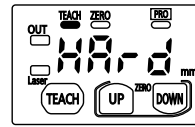

Stable sensing is not possible.

3-point teaching (window comparator mode)

This is the method to perform 3-point teaching (P-1, P-2, P-3) and to set the threshold range by setting threshold 1_SL in the mid-point between the 1st time and 2nd time, and threshold 2_SL in the mid-point between the 2nd time and 3rd time as shown in the following figure.

When performing 3-point teaching (window comparator mode), preset "Window comparator mode 3" in the sensing output setting of the PRO mode.

For the setting method, refer to section 12, "PRO mode setting."

When performing teaching, use sensing objects (P-1, P-2, P-3) with different distance.

After teaching, P-1, P-2 and P-3 will be automatically rearranged from the smaller value.

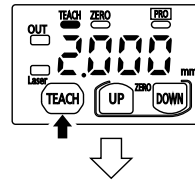
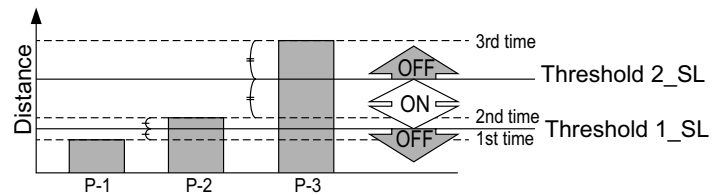

1. Press the TEACH key when the sensing object P-1 is present (1st time).

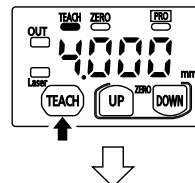

2. Press the TEACH key when the sensing object P-2 is present (second time).

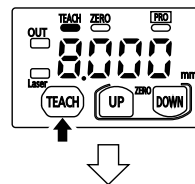

3. Press the TEACH key when the sensing object P-3 is present (3rd time).

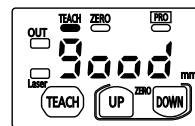

Stable sensing is possible.

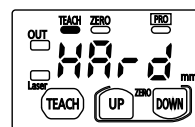

Stable sensing is not possible.

Span adjustment in 'Rising differential mode' or 'Trailing differential mode'

This mode is used to cancel the gradual changes in the measured values and to only detect sudden changes.

To use the Rising differential mode or Trailing differential mode, preset 'Rising differential mode' or 'Trailing differential mode' in the sensing output setting of the PRO mode.

For the setting method, refer to section 12, "PRO mode setting."

The threshold can be set by using the threshold value fine adjustment function, see section 8, "Threshold value fine adjustment function".

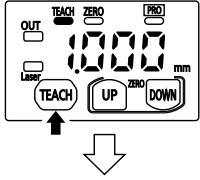

1. Press the TEACH key.

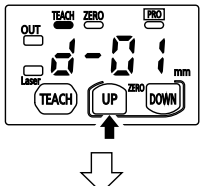

2. Press the UP key or DOWN key to select the span.

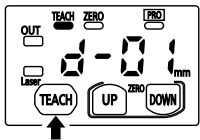
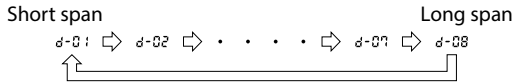

3. Press the TEACH key to set the span.

8 Threshold value fine adjustment function

- The fine adjustment of the threshold can be performed in the measurement display.
- The fine adjustment of the threshold can be performed even after teaching.

'Normal sensing mode', 'Rising differential mode' and 'Trailing differential mode'

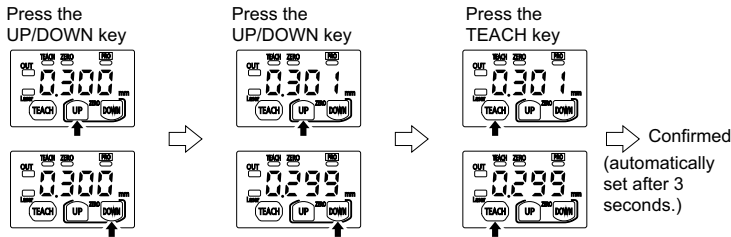

Window comparator mode

When the sensing output is set to window comparator mode, the display 1.5L and 2.5L can be changed only by pressing the TEACH key for 1 second.

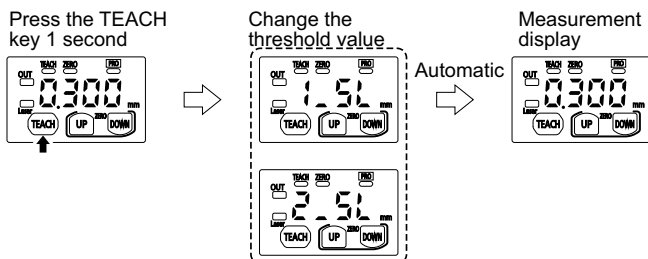

When performing a fine adjustment of the threshold of 1.5L or 2.5L, press the UP key or DOWN key. After 1.5L or 2.5L is displayed, the fine adjustment of the threshold can be performed.

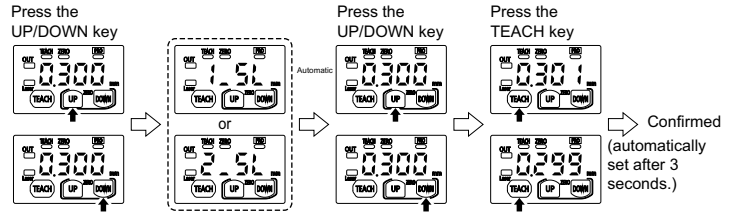

9 Peak / bottom hold function

The peak / bottom hold function is for displaying the peak value and the bottom value.

When the zero set function is executed while the peak / bottom hold function is set to "Peak hold" or "Bottom hold", the held measured value will be reset.

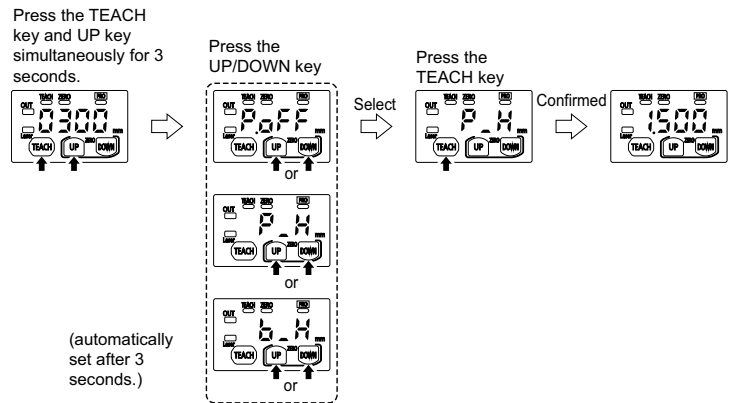

Digital display	Description	Function
P.OFF	Hold function release	Releases the hold status, and outputs the current measured value
P.H	Peak hold	Holds maximum measured value
B.H	Bottom hold	Holds minimum measured value

10 Zero set function

The zero set function is the function to compulsory set the measured value to 'zero'.

The zero set indicator (yellow) will turn ON when the zero set is valid.

When the display setting is set to Offset, the zero set function cannot be set.

"Zero set" setting

Press the UP and DOWN key simultaneously for 3 seconds.



Zero set release

Press the UP and DOWN key simultaneously for 6 seconds.

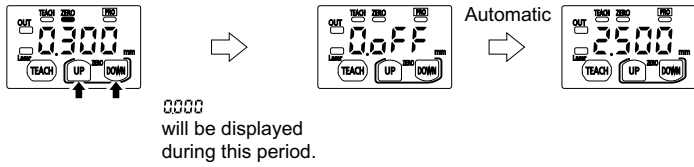

The setting or releasing of the zero set from an external input operates as in the following figure.

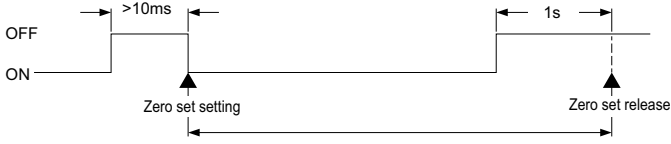

When the power is turned ON again, zero set from external input can be released. At this time, the zero set will not be saved.

Even when the zero set is set in the sensor, the zero set can be set or released from an external input. However, when the power is turned ON again, the zero set set in the sensor will be displayed.

11 Key lock function

The key lock function is to prevent acceptance of key operations, so that the conditions in each setting mode are not changed accidentally.

When the key operation is performed after the key lock is set, "L o c" will be displayed on the digital display.

Key lock setting

Press the TEACH key and DOWN key simultaneously for 3 seconds.

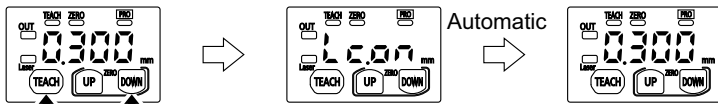

Key lock release

Press the TEACH key and DOWN key simultaneously for 3 seconds.

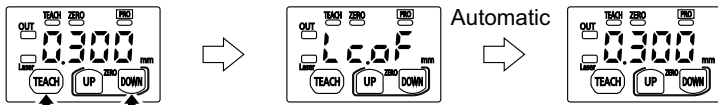

12 PRO mode setting

Part description

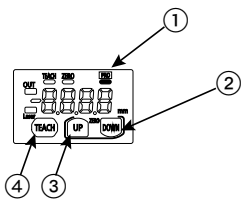

No.	Item
①	PRO indicator (Yellow)
②	DOWN key (Select)
③	UP key (Select)
④	TEACH key (Confirmed)

Arrow description in figures

Arrow	Description
↔	Press the TEACH key
↔	Press UP key or DOWN key
↔	Press DOWN key

Press the DOWN key for 3 seconds or more to switch to PRO MODE. The PRO indicator (yellow) will turn ON when the PRO MODE is active. To return to the measurement display, press the DOWN key again for 3 seconds or more.

Setting	Default setting	Description
Response speed	H-50	Set the response time. "H-50": High precision 10ms "Std": Standard 5ms "Fast": High speed 1.5ms
Output operation	L-on	Select the control output operation mode. "L-on": Light-ON, "d-on": Dark-ON
Sensing output	- - -	Set the sensing output. "Normal": Normal sensing mode "N-1": 1-point teaching (Window comparator mode) "N-2": 2-point teaching (Window comparator mode) "N-3": 3-point teaching (Window comparator mode) "d-f": Trailing differential mode "d-l": Trailing differential mode
Analog output	uolt	Set the output operation of the analog output "uolt": Analog voltage output (0 to +5V) "iolt": Analog current output (4 to 20mA)
Hysteresis	HG-C1030: 0010 HG-C1050: 003 HG-C1100: 007 HG-C1200: 02 HG-C1400: 08	Set the hysteresis width. HG-C1030 : 0.001 to 5.00mm HG-C1050 : 0.01 to 15.00mm HG-C1100 : 0.02 to 35.00mm HG-C1200 : 0.1 to 80.00mm HG-C1400 : 0.2 to 200.00mm
External input	0set	Set the external input. "0set": Zero set function, "tch": Teaching function "L-of": Light emitting stop function "trig": Trigger function
Timer	non	Set the timer operation. The timer time is fixed at 5ms. "non": No timer, "ofd": OFF-delay timer "ond": ON-delay timer "osd": One-shot timer
Display	Std	The display of the measured value can be changed. "Std": Normal "Inv": Invert "ofst": Offset
Hold	off	Set the control output and the analogue output operation when a measurement error occurs (insufficient light intensity, saturation of light intensity, out of measurement range). "off": Hold OFF "on": Hold ON
ECO	off	The digital display can be set to go OFF when key operation is not performed for 30 seconds. Current consumption can be reduced. "off": ECO OFF "on": ECO ON
Reset	no	Return to the default setting (factory setting). "no": Reset NG "y5": Reset OK

Procedure

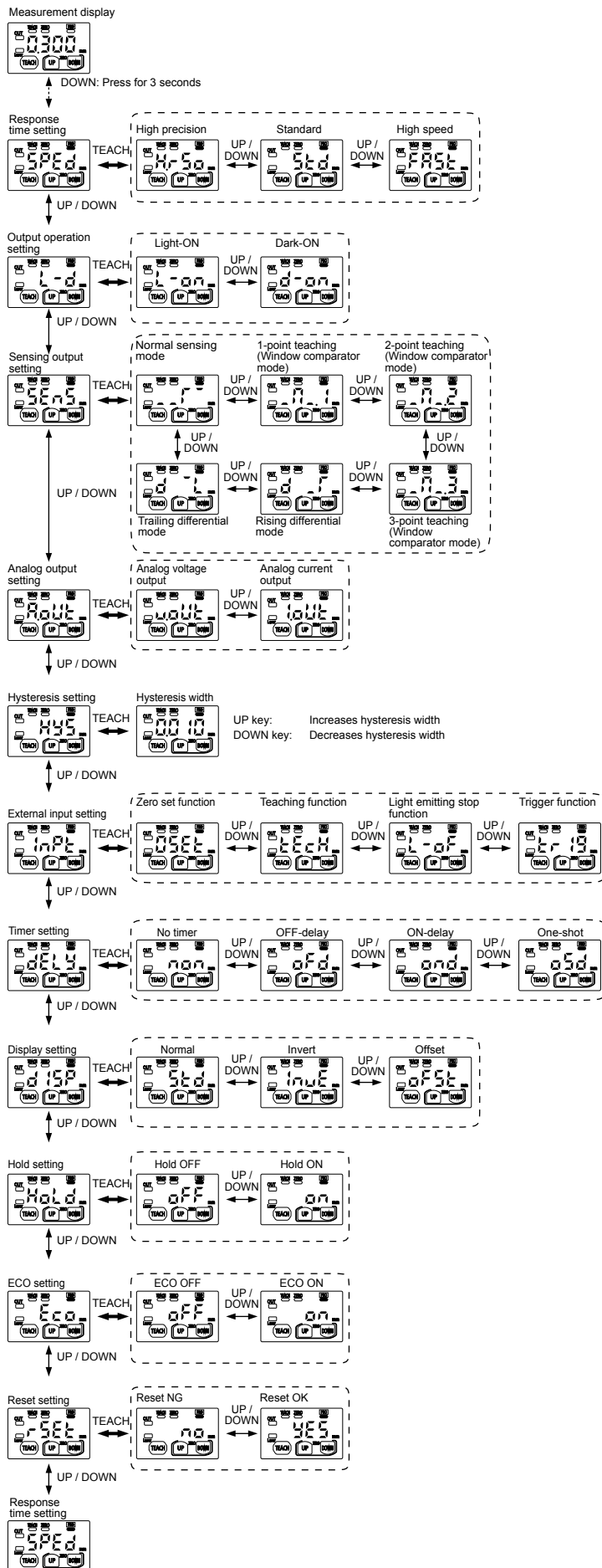

13 Error indication

In case of error, attempt the following measures.

Error indication	Description	Solution
Hold OFF ---- Hold ON Measured value blinks	Insufficient amount of reflected light. The sensing object is out of the sensing range.	Confirm that the sensing distance is within the specification range. Adjust the installation angle of the sensor.
E-01	Flash memory is damaged or passed its life expectancy.	Please contact our office.
E-11	Load of the sensing output is short-circuited causing an over-current to flow.	Turn OFF the power and check the load.
E-21	The semiconductor laser is damaged or passed its life expectancy.	Please contact our office.
E-31	When zero set is set, the measurement is not performed normally. Since the display setting is set to "Offset", the zero set function can not be used.	Confirm that the sensing distance is within the specification range. Set the display to any setting except "Offset".
E-41	During teaching, the measurement is not performed normally.	Confirm that the sensing distance is within the specification range.
E-90 E-91 E-92 E-93	System error	Please contact our office.

14 Cautions

- This product has been developed / produced for industrial use only.
- Make sure that the power supply is OFF before starting the wiring.
- If the wiring is performed incorrectly, it will cause a failure.
- Do not run the wires together with high-voltage lines or power lines, or put them in the same raceway. This can cause malfunction due to induction.
- Verify that the supply voltage variation is within the rating.
- If power is supplied from a commercial switching regulator, ensure that the frame ground (F.G.) terminal of the power supply is connected to an actual ground.
- If noise generating devices (switching regulators, inverter motors, etc.) are used around the sensor mounting area, make sure to connect the frame ground (FG) terminal of the device.
- Do not use this product during the transient state when the power supply is turned ON.
- The overall length of the cable can be extended to 10m maximum with a cable size of max. 0.3mm².
- Make sure that stress by forcible bend or pulling is not applied to the sensor cable joint.
- Although it depends on the type, light from rapid start type or high frequency lighting type, fluorescent lights, sunlight and etc. may affect the sensing, therefore make sure to prevent direct incident light.
- This product is suitable for indoor use only.
- Keep water, oil, fingerprints and etc. which reflect light, dust or particles etc. which interrupt the light, away from the emitting / receiving surfaces of this product. If contaminants adhere to the surface, wipe off with a dust-free soft cloth, or lens cleaning paper.
- Do not use the sensor in locations where there is excessive vapor, dust or etc. or in an atmosphere where corrosive gases, etc. are generated.
- Take care that the product does not come in contact with oil, grease, organic solvents such as thinner, etc., strong acid or alkaline.
- Make sure to turn OFF the power supply, before cleaning the light emitting / receiving windows of the sensor head.

14 Specifications

NPN output	HG-C1030	HG-C1050	HG-C1100	HG-C1200	HG-C1400
PNP output	HG-C1030-P	HG-C1050-P	HG-C1100-P	HG-C1200-P	HG-C1400-P
Measurement center distance	30mm	50mm	100mm	200mm	400mm
Measurement range	±5mm	±15mm	±35mm	±80mm	±200mm
Repeatability	10μm	30μm	70μm	70μm	<ul style="list-style-type: none"> • 300μm (measurement distance 200 to 400mm) • 800μm (measurement distance 400 to 600mm)
Linearity	±0,1% F.S.			±0,2% F.S.	<ul style="list-style-type: none"> • ±0,2% F.S. (measurement distance 200 to 400mm) • ±0,3% F.S. (measurement distance 400 to 600mm)
Temperature characteristic	0.03%F.S./°C				
Beam diameter ²	≈ 50μm	≈ 70μm	≈ 120μm	≈ 300μm	≈ 500μm
Light source	Red semiconductor laser class 2 (JIS / IEC / GB) / class II Max. output: 1mW, emission peak wavelength: 655nm				
Supply voltage	12 to 24V DC ±10% including ripple max. 10% (P-P)				
Power consumption	max. 40mA (at 24V DC supply voltage), max. 60mA (at 12V DC supply voltage)				
Control Output	NPN output type: NPN open collector transistor		PNP output type: PNP open-collector transistor		
	<ul style="list-style-type: none"> • Maximum sink current: 50mA • Applied voltage: max. 30V DC (between control output to 0V) • Residual voltage: max. 1.5V (at 50mA sink current) • Leakage current: max. 0.1mA 		<ul style="list-style-type: none"> • Maximum source current: 50mA • Applied voltage: max. 30V DC (between control output to 0V) • Residual voltage: max. 1.5V (at 50mA source current) • Leakage current: max. 0.1mA 		
	Output operation	Selectable either Light-ON or Dark-ON			
Short-circuit protection	Incorporated (auto-reset)				
Analog voltage output	Voltage output: 0 to 5V (Alarm: +5.2V) Output impedance: 100Ω				
Analog current output	Current output: 4 to +5V (Alarm: 0mA) Load impedance: max. 250Ω				
Response time	Switchable between high speed (1.5ms), standard (5ms), and high precision (10ms)				
External input	NPN output type: NPN non-contact input		PNP output type: PNP non-contact input		
	Input conditions: Invalid: +8 to +V DC or open Valid: 0 to +1.2V DC Input impedance: ≈ 10kΩ		Input conditions: Invalid: 0 to +0.6V DC or open Valid: +4 to +V DC Input impedance: ≈ 10kΩ		
Degree of protection	IP67 (IEC)				
Degree of pollution	2				
Ambient temperature	-10 to +45°C (no dew condensation or icing allowed), storage: -20 to +60°C				
Ambient humidity	35 to 85% RH, at storage: 35 to 85% RH				
Ambient illumination	3000lx max. (Illumination level of light receiving surface under incandescent light)				
Operating altitude	Max. 2000m				
Cable	0.2mm ² 5-core composite cable, 2m long 2m				
Material	Enclosure: die-cast aluminum, front cover: acrylic				
Weight	≈ 35g (without cable), ≈ 85g (including cable)				
Applicable standards	EMC Directive				

¹ Measurement conditions: 24V supply voltage, 20°C ambient temperature, 10ms response time. The subject is white ceramics.

² This is the size in the measurement center distance. These values were defined by using 1/e² (approx. 13.5%) of the center light intensity. Due to leak light outside the specified area, the reflectance around the detecting point may be higher than at the point and this may affect the measurement value.

Panasonic Industrial Devices SUNX Co., Ltd.

<http://panasonic.net/id/pidsx/global>

Overseas Sales Dept. (Head Office)

2431-1 Ushiyama-cho, Kasugai-shi, Aichi, 486-0901, Japan

Telefon: +81-(0)-568-33-7861 FAX: +81-568-33-8591

Europe Headquarter: Panasonic Electric Works Europe AG

Robert-Koch-Straße 100, D-85521 Ottobrunn, Germany

Telefon: +49-89-45354-1000