

Features

- Ultra High Efficiency (Up to 91%)
- Active Power Factor Correction (0.99 Typical)
- Constant Current Output
- Lightning Protection
- All-Around Protection: SCP, OTP, OVP
- Waterproof (IP67) and Damp & Wet Location



CE CB TUV

Description

The EUC-100SxxxDV(SV) Series operates from a 90 ~ 305 Vac input range. They are designed to be highly efficient and highly reliable. The standard features include dimming control, lightning protection, over voltage protection, short circuit protection, and over temperature protection.

Models

Output Current	Input Voltage Range	Output Voltage Range	Max. Output Power	Typical Efficiency (1)	Power Factor		Model Number (2)
					120Vac	220Vac	
350 mA	90 ~ 305 Vac	172~286Vdc	100 W	91.0%	0.99	0.96	EUC-100S035DV(SV)★
450 mA	90 ~ 305 Vac	132~222Vdc	100 W	91.0%	0.99	0.96	EUC-100S045DV(SV)★
700 mA	90 ~ 305 Vac	86~143Vdc	100 W	90.5%	0.99	0.96	EUC-100S070DV(SV)★
1050 mA	90 ~ 305 Vac	57~95 Vdc	100 W	90.5%	0.99	0.96	EUC-100S105DV(SV)(3)★
1400 mA	90 ~ 305 Vac	43~71 Vdc	100 W	90.5%	0.99	0.96	EUC-100S140DV(SV)(3)
1750 mA	90 ~ 305 Vac	34~57 Vdc	100 W	90.5%	0.99	0.96	EUC-100S175DV(SV)(3)
2100 mA	90 ~ 305 Vac	29~48 Vdc	100 W	90.5%	0.99	0.96	EUC-100S210DV(SV)(3)★
2450 mA	90 ~ 305 Vac	25~41 Vdc	100 W	90.5%	0.99	0.96	EUC-100S245DV(SV)(3)★
2800 mA	90 ~ 305 Vac	22~36 Vdc	100 W	90.0%	0.99	0.96	EUC-100S280DV(SV)(3)
3150 mA	90 ~ 305 Vac	19~32 Vdc	100 W	90.0%	0.99	0.96	EUC-100S315DV(SV)(3)★
3570 mA	90 ~ 305 Vac	17~28 Vdc	100 W	90.0%	0.99	0.96	EUC-100S357DV(SV)(3)
4200 mA	90 ~ 305 Vac	14~24 Vdc	100 W	89.0%	0.99	0.96	EUC-100S420DV(SV)(3)

- Notes:**
- (1) Measured at full load and 220 Vac input.
 - (2) A suffix -xxxx may be added to denote variations or modifications to the base product, where x can be any alphanumeric character or blank.
 - (3) SELV
 - (4) ★: Popular model.

Input Specifications

Parameter	Min.	Typ.	Max.	Notes
Input Voltage	90 V	-	305 V	
Input Frequency	47 Hz	-	63 Hz	
Leakage Current	-	-	1 mA	At 277Vac 60Hz input
Input AC Current	-	-	1.3 A	Measured at full load and 100 Vac input.
	-	-	0.6 A	Measured at full load and 220 Vac input.
Inrush current	-	-	65 A	At 220Vac input, 25 °C cold start, duration=1 ms, 10%Ipk-10%Ipk.
Inrush Current(I ² t)	-	-	1 A ² s	
Power Factor	0.90	-	-	At 100Vac-220Vac, 75%load-100%load
THD	-	-	20%	At 100Vac-277Vac, 75%load-100%load

Output Specifications

Parameter	Min.	Typ.	Max.	Notes
Output Current Range				Vdim=10 V
I _o = 350 mA	332 mA	350 mA	368 mA	
I _o = 450 mA	427 mA	450 mA	473 mA	
I _o = 700 mA	665 mA	700 mA	735 mA	
I _o = 1050 mA	997 mA	1050 mA	1102 mA	
I _o = 1400 mA	1330 mA	1400 mA	1470 mA	
I _o = 1750 mA	1662 mA	1750 mA	1837 mA	
I _o = 2100 mA	1995 mA	2100 mA	2205 mA	
I _o = 2450 mA	2327 mA	2450 mA	2572 mA	
I _o = 2800 mA	2660 mA	2800 mA	2940 mA	
I _o = 3150 mA	2992 mA	3150 mA	3307 mA	
I _o = 3570 mA	3391 mA	3570 mA	3748 mA	
I _o = 4200 mA	3990 mA	4200 mA	4410 mA	
Ripple and Noise (pk-pk)	-	-	3% V _O	Measured by 20 MHz bandwidth oscilloscope and the output paralleled a 0.1 uF ceramic capacitor and a 10 uF electrolytic capacitor.
Line Regulation	-	-	±1%	
Load Regulation	-	-	±3%	
Turn-on Delay Time	-	1.2 s	2.0 s	Measured at 120Vac input.
	-	0.6 s	1.2 s	Measured at 220Vac input.

Note: All specifications are typical at 25 °C unless otherwise stated.

Protection Functions

Parameter	Min.	Typ.	Max.	Notes
Over Temperature Protection	-	100 °C	-	Case temperature
Short Circuit Protection	No damage shall occur when any output operating in a short circuit condition. The power supply shall be self-recovery when the fault condition is removed.			

Protection Functions (Continued)

Parameter	Min.	Typ.	Max.	Notes
Over Voltage Protection				
I _o = 350 mA	343 V	372 V	401 V	Latch mode. The power supply shall return to normal operation only after the power is turn-on again.
I _o = 450 mA	266 V	289 V	311 V	
I _o = 700 mA	171 V	186 V	200 V	
I _o = 1050 mA	114 V	124 V	133 V	
I _o = 1400 mA	86 V	94 V	101 V	
I _o = 1750 mA	68 V	74 V	80 V	
I _o = 2100 mA	57 V	63 V	67 V	
I _o = 2450 mA	49 V	53 V	58 V	
I _o = 2800 mA	43 V	47 V	51 V	
I _o = 3150 mA	38 V	42 V	45 V	
I _o = 3570 mA	33 V	36 V	40 V	
I _o = 4200 mA	28V	31 V	34 V	

General Specifications

Parameter	Min.	Typ.	Max.	Notes
Efficiency				
I _o = 350 mA	88.0%	89.0%	-	Measured at full load, 110Vac input, 25°C ambient temperature, after the unit is thermally stabilized. It will be lower about 1%, if measured immediately after startup.
I _o = 450 mA	88.0%	89.0%	-	
I _o = 700 mA	87.5%	88.5%	-	
I _o = 1050 mA	87.5%	88.5%	-	
I _o = 1400 mA	87.5%	88.5%	-	
I _o = 1750 mA	87.5%	88.5%	-	
I _o = 2100 mA	87.5%	88.5%	-	
I _o = 2450 mA	87.5%	88.5%	-	
I _o = 2800 mA	87.0%	88.0%	-	
I _o = 3150 mA	87.0%	88.0%	-	
I _o = 3570 mA	87.0%	88.0%	-	
I _o = 4200 mA	86.0%	87.0%	-	
Efficiency				
I _o = 350 mA	90.0%	91.0%	-	Measured at full load, 220Vac input, 25°C ambient temperature, after the unit is thermally stabilized. It will be lower about 1%, if measured immediately after startup.
I _o = 450 mA	90.0%	91.0%	-	
I _o = 700 mA	89.5%	90.5%	-	
I _o = 1050 mA	89.5%	90.5%	-	
I _o = 1400 mA	89.5%	90.5%	-	
I _o = 1750 mA	89.5%	90.5%	-	
I _o = 2100 mA	89.5%	90.5%	-	
I _o = 2450 mA	89.5%	90.5%	-	
I _o = 2800 mA	89.0%	90.0%	-	
I _o = 3150 mA	89.0%	90.0%	-	
I _o = 3570 mA	89.0%	90.0%	-	
I _o = 4200 mA	88.0%	89.0%	-	
MTBF	-	250,000 hours	-	Measured at 120Vac input, 80%Load and 25°C ambient temperature (MIL-HDBK-217F)
Life Time	-	75,500 hours	-	Measured at 220Vac input, 80%Load, Case temperature=60°C @ Tc point. See life time vs. Tc curve for the details
Case Temperature	-	-	90°C	
Dimensions				
Inches (L x W x H)	7.64 x 2.66 x 1.44			
Millimeters (L x W x H)	194 x 67.5 x 36.5			
Net Weight	-	1000 g	-	

Note: All specifications are typical at 25 °C unless otherwise stated.

Environmental Specifications

Parameter	Min.	Typ.	Max.	Notes
Operating Temperature	-35 °C	-	+65 °C	Humidity: 10% RH to 100% RH See Derating Curve for more details
Storage Temperature	-40 °C	-	+85 °C	Humidity: 5% RH to 100% RH

Safety & EMC Compliance

Safety Category	Standard
CE	EN 61347-1, EN61347-2-13
EMI Standards	Notes
EN 55015	Conducted emission Test & Radiated emission Test
EN 61000-3-2	Harmonic current emissions
EN 61000-3-3	Voltage fluctuations & flicker
EMS Standards	Notes
EN 61000-4-2	Electrostatic Discharge (ESD): 8 kV air discharge, 4 kV contact discharge
EN 61000-4-3	Radio-Frequency Electromagnetic Field Susceptibility Test-RS
EN 61000-4-4	Electrical Fast Transient / Burst-EFT
EN 61000-4-5	Surge Immunity Test: AC Power Line: line to line 4 kV, line to earth 6 kV
EN 61000-4-6	Conducted Radio Frequency Disturbances Test-CS
EN 61000-4-8	Power Frequency Magnetic Field Test
EN 61000-4-11	Voltage Dips
EN 61547	Electromagnetic Immunity Requirements Applies To Lighting Equipment

Derating Curve

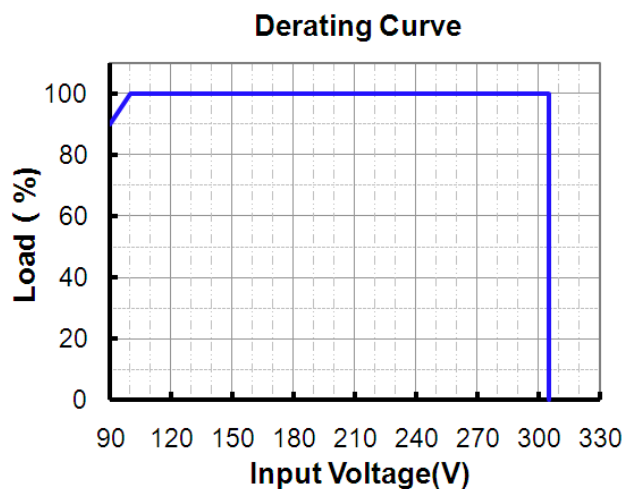
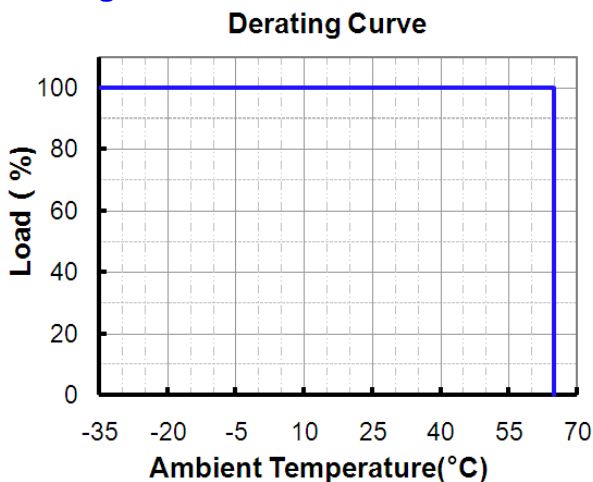

Life Time vs. Case Temperature Curve

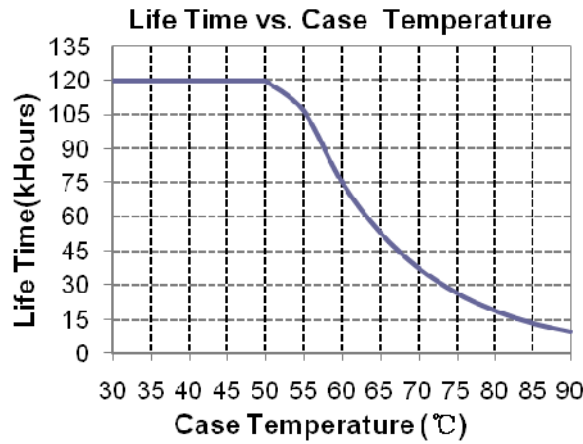

Power Factor Characteristics

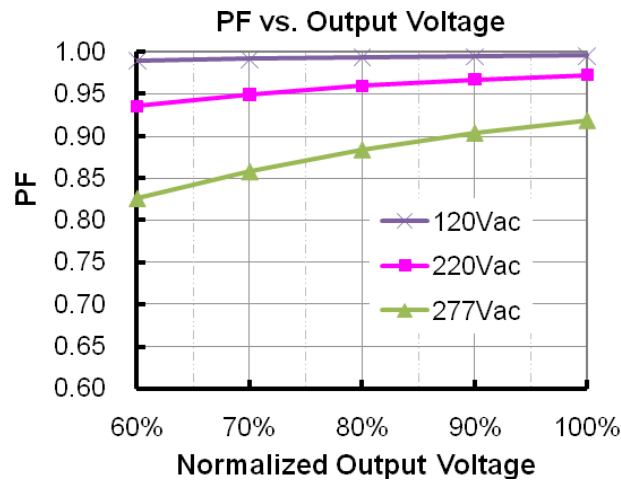

Total Harmonic Distortion

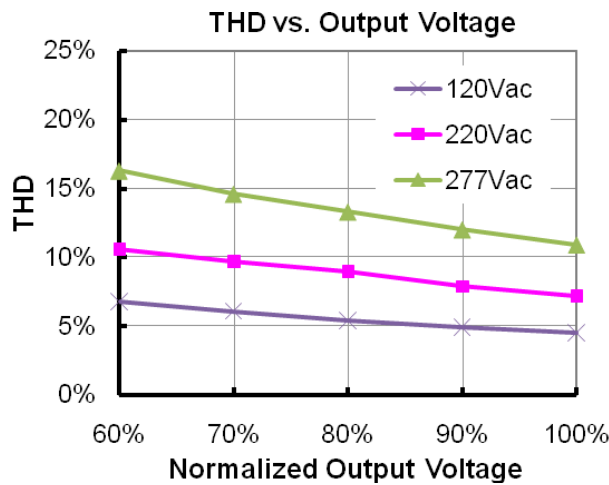

Dimming Control (One Secondary Side)

The function has two versions. One is with internal pull-up resistor; the output is full load when the dimming leads are floated. Another is with internal pull-down resistor; the output is 10% full load when the dimming leads are floated.

1. With pull-up resistor (Default, without suffix):

Parameter	Min.	Typ.	Max.	Notes
Vcc	9.5 V	10 V	10.5 V	
10V output source current	0 mA	-	10 mA	
Absolute maximum voltage on the 1~10V input pin	-2 V	-	12 V	
Source current on 1~10V input pin	0 mA	-	0.5 mA	
Value of Rin (the resistor inside the LED driver which locate between the 1-10V input and 10V output pin)	19.8 K	20 K	20.2 K	

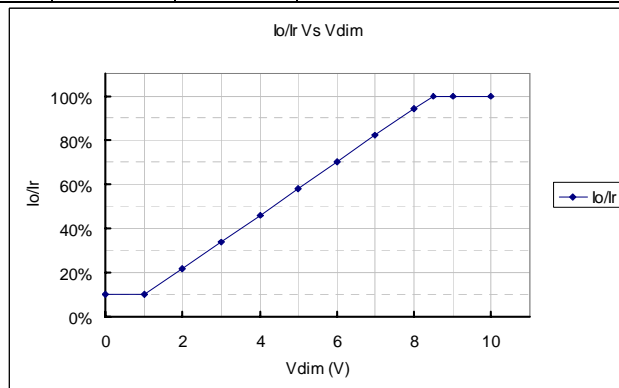
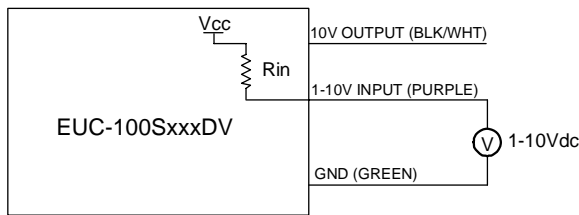

Implementation 1: DC input

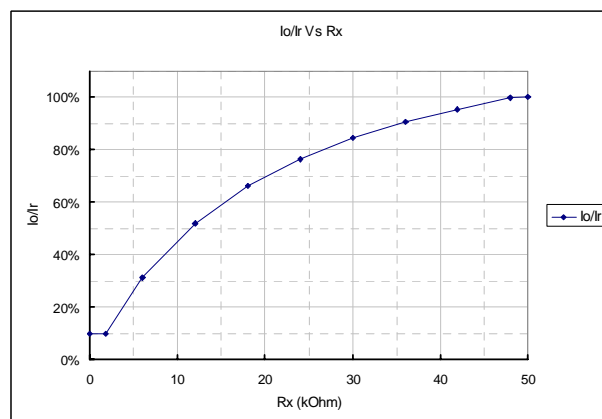
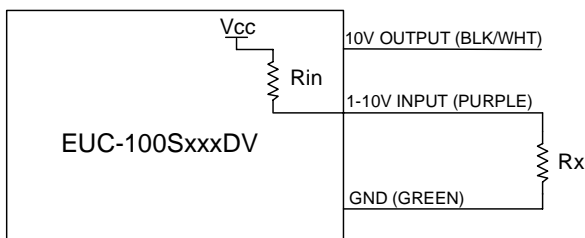

Implementation 2: External resistor (Vcc=12V) [EUC-100S315DV & EUC-100S420DV]

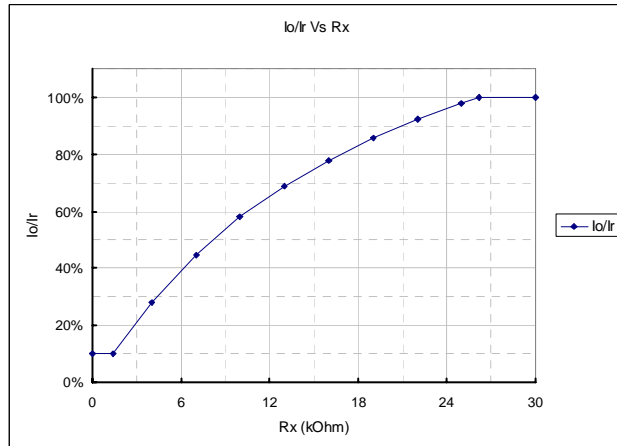
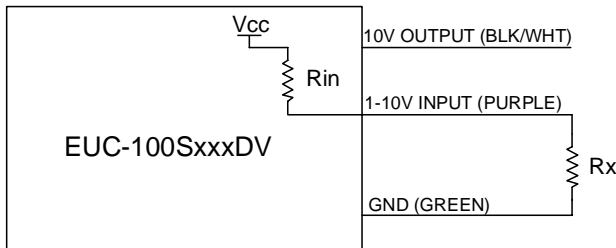

Implementation 3: External resistor ($V_{cc}=15V$) [Other Models]

Notes:

1. If the dimming function is not used, please let the dimming leads floated.
2. I_o is actual output current and I_r is rated current without dimming control.
3. For the driver to operate properly, the load voltage must be maintained above the minimum voltage threshold (approx.60% of the max. output voltage for any given model).
4. If the output voltage is maintained above 60% of the maximum output voltage, the dimming control may be operated over the entire 1-10V range with output current varying from 100% down to practically 10%.
5. The dimming signal is allowed to be less than 1V, however, when it for 0-1V, the output current can maintain about 10% I_r . When it for 8.5-10V, the output current can maintain about 100% I_r .
6. Do not connect the GND of dimming to the output; otherwise, the LED driver cannot work normally.

2. With pull-down resistor: (The model number has a suffix -0040)

Parameter	Min.	Typ.	Max.	Notes
10V output voltage	9.5 V	10 V	10.5 V	
10V output source current	0 mA	-	10 mA	
Absolute maximum voltage on the 1~10V input pin	-2 V	-	12 V	
Sink current on 1~10V input pin	0 mA	-	1 mA	
Value of R_{in} (the resistor inside the LED driver which locate between the 1-10V input and GND)	9.9 K	10 K	10.1 K	

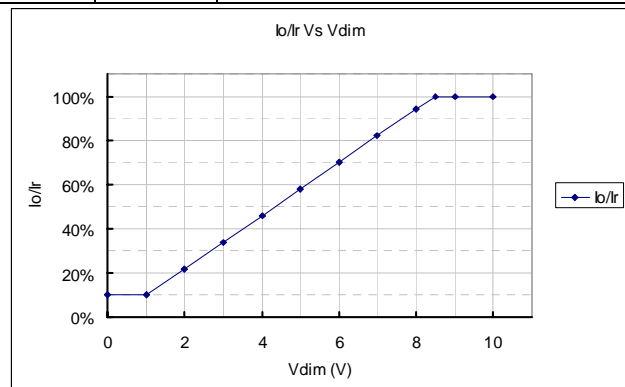
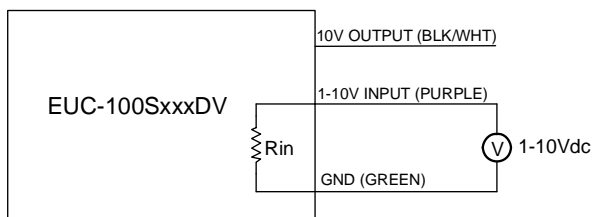

Implementation 1: DC input

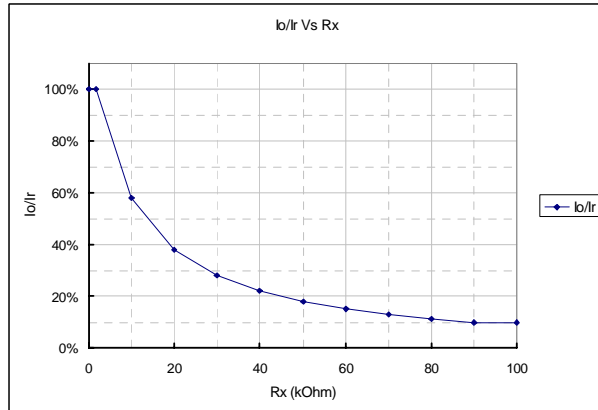
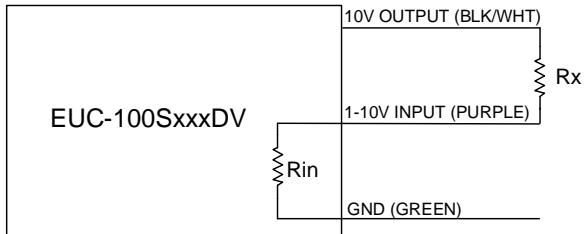

Implementation 2: External resistor

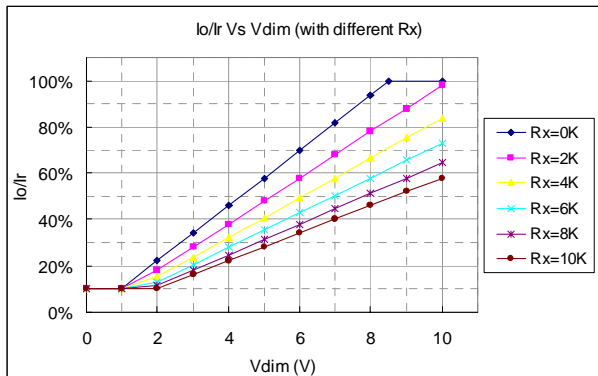
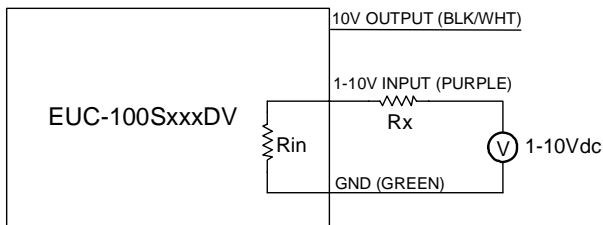

Implementation 3: External resistor and 1-10V DC Input

Notes:

1. If the dimming function is not used, please short 10V output pin (yellow) and 1-10 input pin (purple).
2. I_o is actual output current and I_r is rated current without dimming control.
3. For the driver to operate properly, the load voltage must be maintained above the minimum voltage threshold (approx. 60% of the max. output voltage for any given model).
4. If the output voltage is maintained above 60% of the maximum output voltage, the dimming control may be operated over the entire 1-10V range with output current varying from 100% down to practically 10%.
5. The dimming signal is allowed to be less than 1V, however, when it for 0-1V, the output current can maintain about 10% I_r . When it for 8.5-10V, the output current can maintain about 100% I_r .
6. Do not connect the GND of dimming to the output; otherwise, the LED driver cannot work normally.

Mechanical Outline

EUC-100SxxxDV

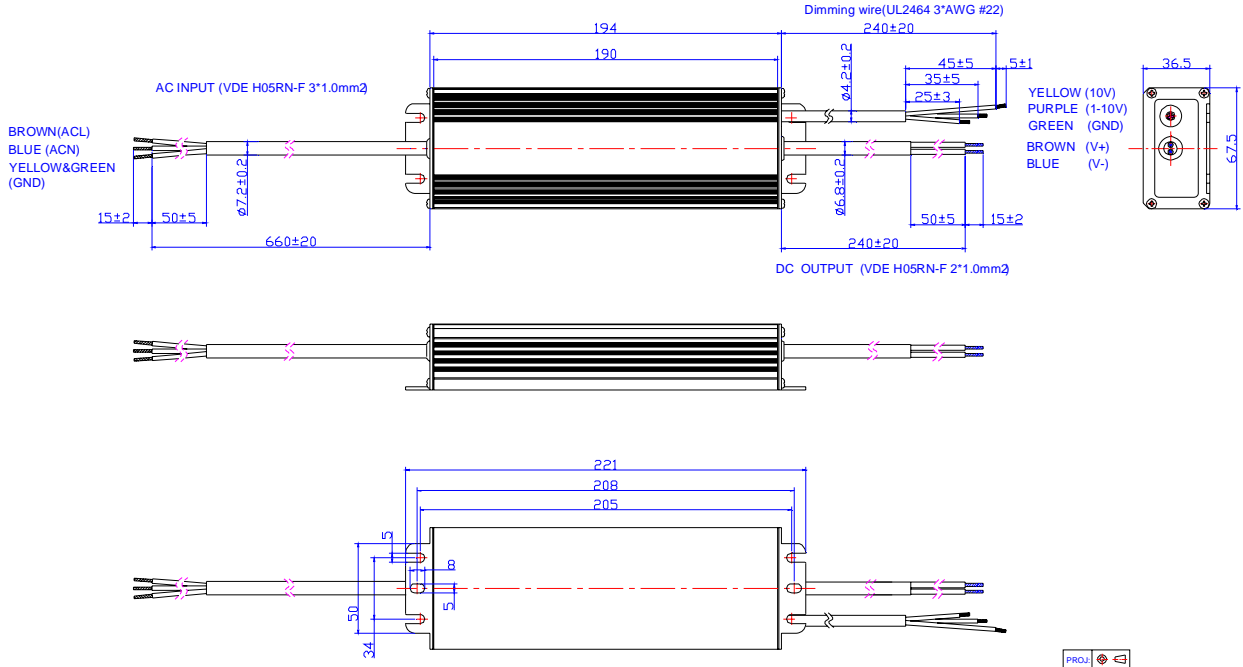

EUC-100SxxxSV

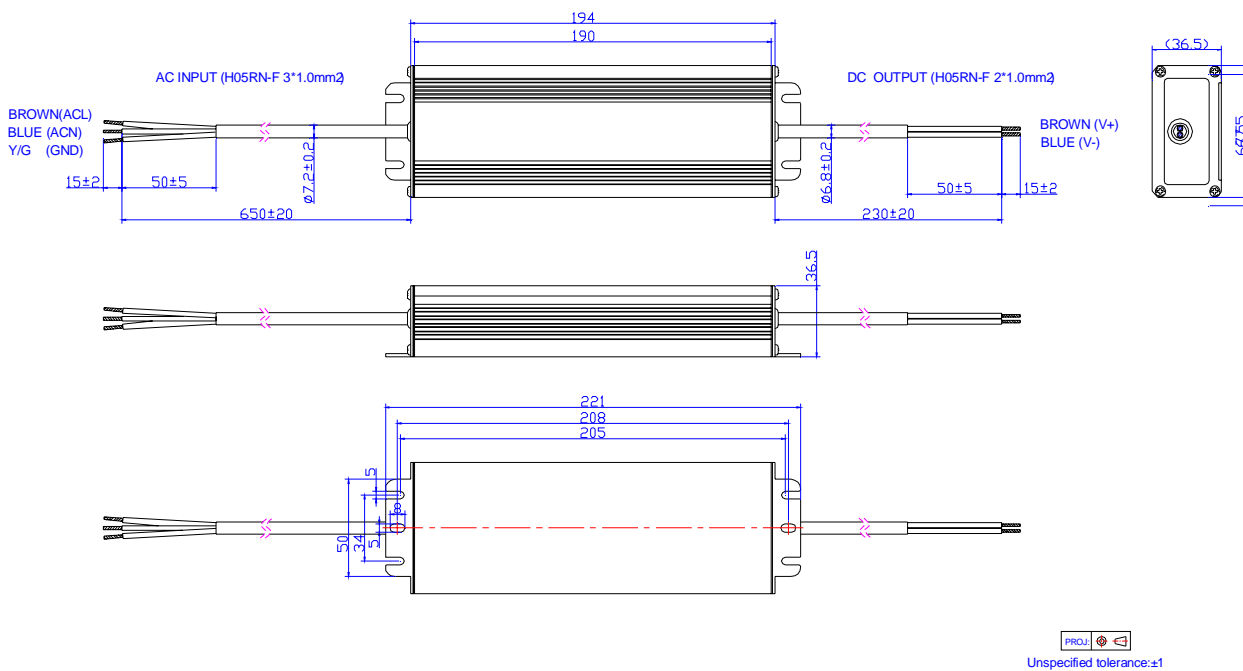

RoHS Compliance

Our products comply with the European Directive 2011/65/EC, calling for the elimination of lead and other hazardous substances from electronic products.

Revision History

Change Date	Rev.	Description of Change		
		Item	From	To
2010-03-23	A	Add Leakage Current in Input Specifications	/	Max. 1 Ma At 277Vac 50Hz input
		Change the Max. value of Operating Temperature	+70 °C	+65 °C
		Change the Max. Ambient Temperature in Derating Curve	+70 °C	+65 °C
		Change the MTBF data and testing condition	450,000 hours / Measured at EUC-100S140DV(SV)	350,000 hours / Measured at EUC-100S105DV(SV)
		Change the Life Time testing condition	Measured at EUC-100S140DV(SV)	Measured at EUC-100S105DV(SV)
		Add one note in Dimming Control	/	7. Do not connect the GND of dimming to the output; otherwise, the LED driver can not work normally.
		Change the dimming control line in Mechanical Outline	/	/
2010-05-31	B	Add star rank for recommended models	/	☆: Popular model.
2010-10-22	C	Update the part of dimming control	/	/
2010-10-18	D	Add another dimming version with pull-down resistor	/	/
2011-01-14	E	Change popular models	/	/
		Update MTBF & Life Time Date	For One Model	For Two Models
2011-09-07	F	Dimming Control	/	/
2012-02-07	G	Turn-on Delay Time at 110 Vac	1.0 s	1.5 s
2012-06-11	H	Mechanical outline	/	Updated
		Life time Curve	/	Added
2012-07-17	I	Max Case Temperature	/	Updated
		Surge Immunity Test: AC Power Line	line to line 2 kV, line to earth 4 kV	line to line 4 kV, line to earth 6 kV
2012-07-24	J	External resistor in pull-up resistor	/	Updated
2012-09-21	K	Inrush Current(I ² t)	/	Added
		MTBF, Life time	/	Typical Value added
		Life time Curve	/	Updated
		Min PF, THD Max	/	Added
2013-03-25	L	Efficiency of Model 4900mA	/	1% lower
		Turn-on delay time @120Vac	Typ 0.6s; Max1.5s	Typ 1.2s; Max2.0s
		Turn-on delay time @220Vac	Typ 0.6s; Max1.0s	Typ 0.6s; Max1.2s
		PF Curve	/	Added
		THD Curve	/	Added
		OTP	/	Updated
		Life time and Life time Curve	/	Updated
		Mechanical outline	/	Updated

