

XSA-305 Xicato Modular Passive Star LED Cooler ø111mm

Features & Benefits

- The XSA-305 Xicato modular passive LED cooler is specifically designed for luminaires using Xicato LED modules. Mechanical compatibility with direct mounting of the LED modules to the LED cooler and thermal performance matching the lumen packages.
- For spot and downlight designs from 4,900 to 9,800 lumen
- Thermal resistance Rth 1.0°C/W
- Modular design with mounting holes foreseen for direct mounting of Xicato XIM, XTM and XCA LED modules.
- Diameter 111mm - Standard height 80mm
Other heights on request
- Extruded from highly conductive aluminum
- Optional accessory cover cap XSA-315

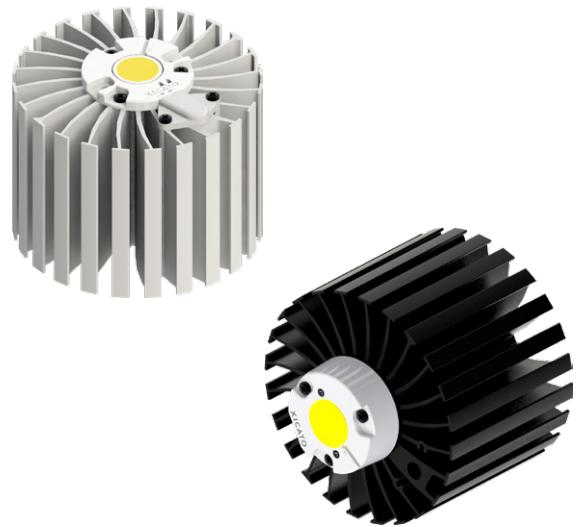

Order Information

Xicato[®]

Example : XSA-305-B

XSA-305- **1**

1 Anodising Color

B - Black
C - Clear

Simple mounting with M3 screws
Recommended screw force 6lb/in

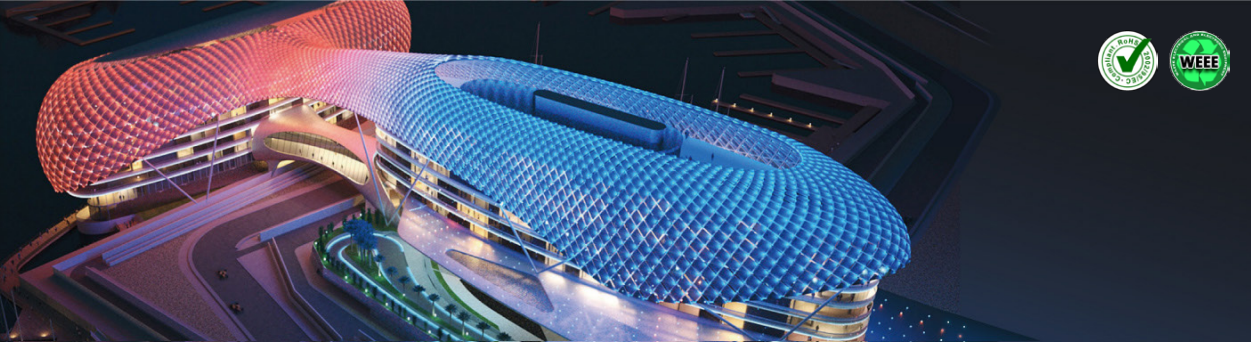

XSA-305 Xicato Modular Passive Star LED Cooler ø111mm

Product Details

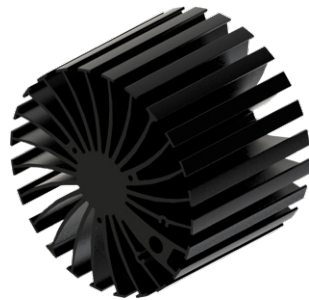

Model n°

XSA-305

Dimension (mm) ^{*1}	ø111 x h80
Volume (mm ³)	247420
Cooling Surface (mm ²)	184709
Weight (gr)	640
Thermal Resistance (°C/W) ^{*2}	1.0
Power Pd (W) ^{*3}	51
Heat Sink Material	AL6063-T5

^{*1} 3D files are available in ParaSolid, STP and IGS on request

^{*2} The thermal resistance Rth is determined with a calibrated heat source of 30mm x 30mm central placed on the heat sink, Tamb 40° and an open environment. Reference data @ heat sink to ambient temperature rise Ths-amb 50°C
 The thermal resistance of a LED cooler is not a fix value and will vary with the applied dissipated power Pd

^{*3} Dissipated power Pd. Reference data @ heat sink to ambient temperature rise Ths-amb 50°C
 The maximal dissipated power needs to be verified in function of required case temperature Tc or junction temperature Tj and related to the estimated ambient temperature where the light fixture will be placed
 Please be aware the dissipated power Pd is not the same as the electrical power Pe of a LED module

To calculate the dissipated power please use the following formula: $Pd = Pe \times (1 - \eta_L)$

Pd - Dissipated power

Pe - Electrical power

η_L = Light efficiency of the LED module

Notes:

- MechaTronix reserves the right to change products or specifications without prior notice.
- Mentioned models are an extraction of full product range.
- For specific mechanical adaptations please contact MechaTronix.

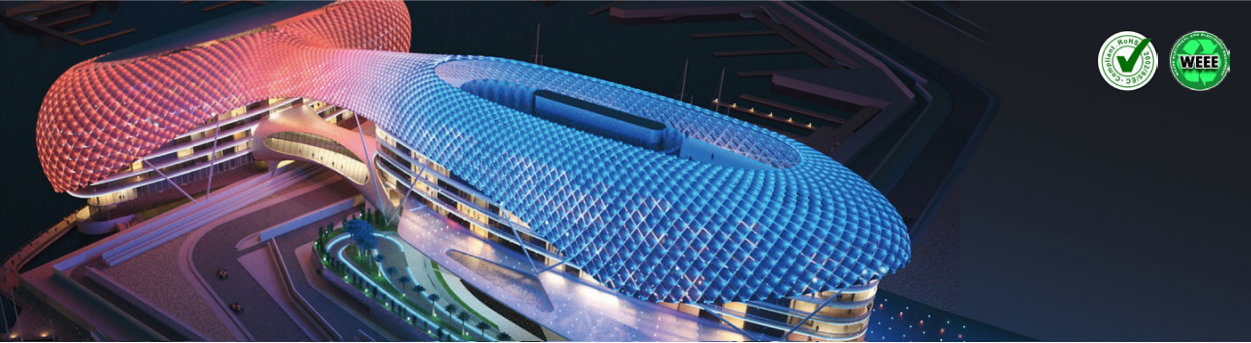

XSA-305 Xicato Modular Passive Star LED Cooler ø111mm

Mounting Instructions



Xicato is changing the way the world looks at light – and enabling everyone to experience it. Xicato believes that with better light, shoppers will buy more, diners will order more and guests will be happier and feel more comfortable. In turn, for owners, operators and managers of environments, better lighting will contribute to high sales, margins and brand perception.

Mounting indicator marks overview

MechaTronix recommends the use of a high thermal conductive interface between the LED module and the LED cooler. Either thermal grease, a thermal pad or a phase change thermal pad thickness 0.1-0.15mm is recommended. Thermal pads or phase change thermal pads can be pre-applied from MechaTronix.

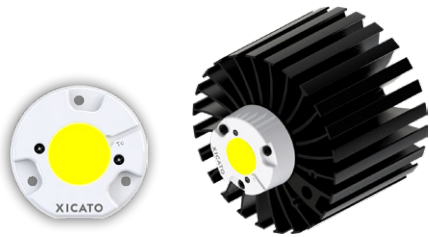
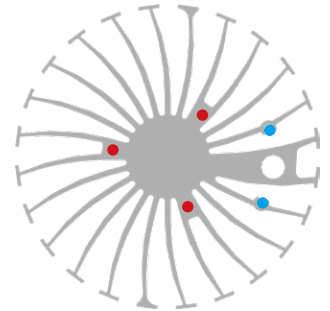

Xicato XIM LED modules

Model names

- XIM09xxxx
- XIM19xxxx

Mounting

- Direct mounting with 3 screws M3 x 20mm
Red indicator marks
- Optional accessory cover cap with 2 self tapping screws M3 x 6mm
Blue indicator marks

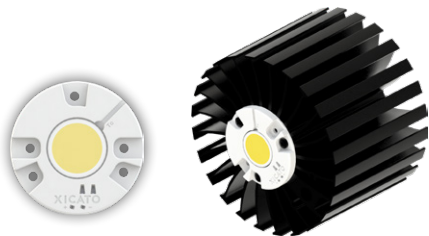

Xicato XTM LED modules

Model names

- XTM09xxxx
- XTM19xxxx

Mounting

- Direct mounting with 3 screws M3 x 8mm
Red indicator marks
- Optional accessory cover cap with 2 self tapping screws M3 x 6mm
Blue indicator marks

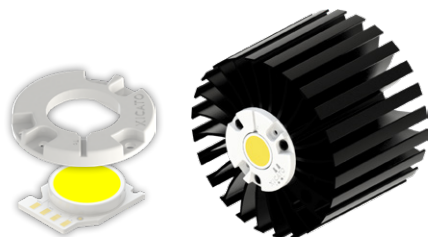

Xicato XCA LED Core Array

Model names

- XCA09xxxx
- XCA19xxxx

Mounting

- With Xicato XSA-401 LED holder
Mounting with 3 screws M3 x 8mm
Red indicator marks
- Optional accessory cover cap with 2 self tapping screws M3 x 6mm
Blue indicator marks

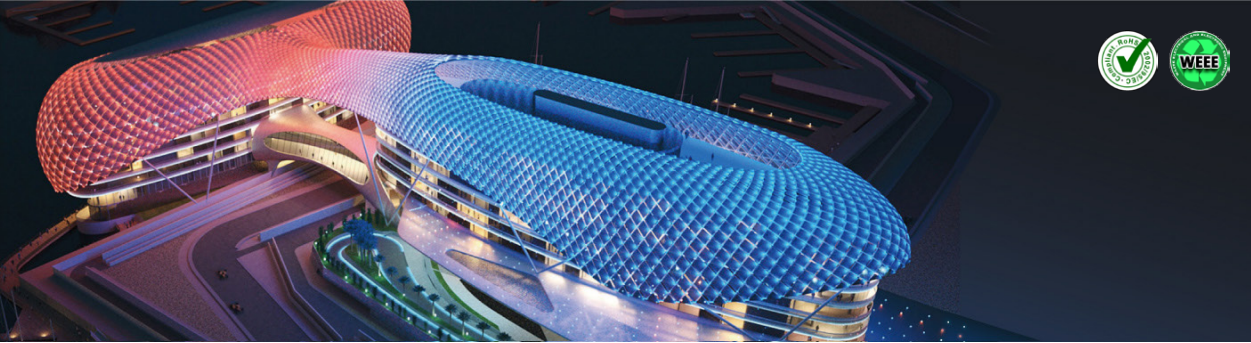

XSA-305 Xicato Modular Passive Star LED Cooler $\phi 111\text{mm}$

Drawings & Dimensions

Example: XSA-305

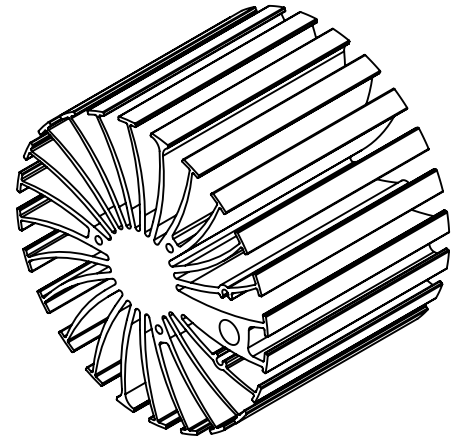
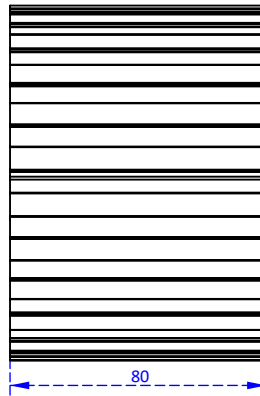
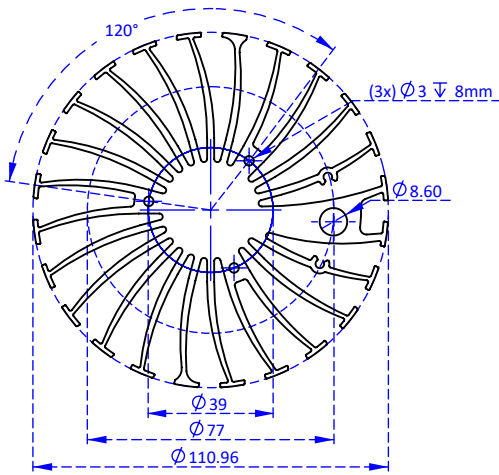

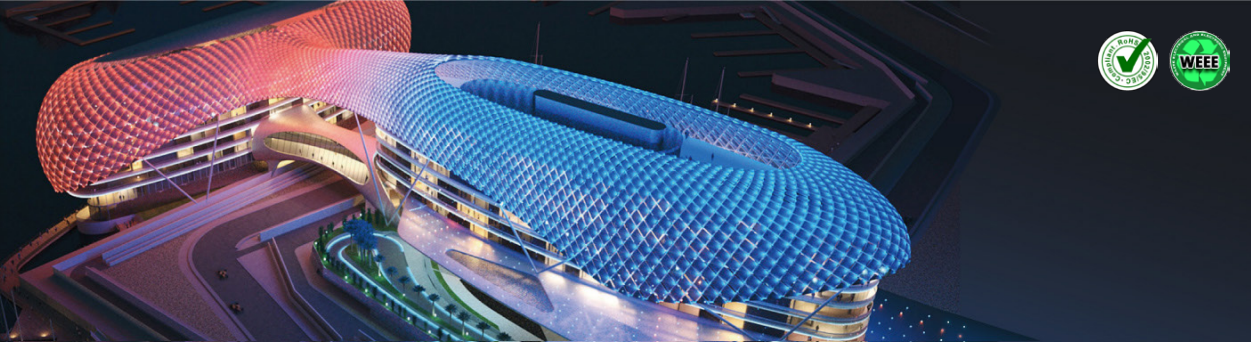

XSA-305 Xicato Modular Passive Star LED Cooler ø111mm

Thermal Data

The thermal performance of a LED cooler, expressed as Thermal Resistance R_{th} in K/W (or °C/W) tells you how many degrees Kelvin (or Celsius) the base of the LED cooler will incline per Watt of dissipated power P_d .

This dissipated power P_d is the heat loss a LED package or LED COB/LOB will create besides the efficient light generation.

Typically for white LED packages the efficiency varies with the color CCT and the CRI – values here below can be taken as a rule of thumb for white LED packages (phosphor corrected blue light)

CCT 4000 - 7000 and CRI 70 - 80 → 35% efficiency → 65% heat loss

CCT 2700 - 3000 and CRI 85 - 97 → 30% efficiency → 70% heat loss

For other LED packages like horticulture specific wave lengths or UV, we recommend you to look up the thermal efficiency in the datasheet or contact the supplier.

Keep in mind that for horticulture LED packages, example 660nm Deep Red, the thermal losses are drastically lower and can be as low as 40%, meaning you could almost use double the electrical power P_e on the same LED cooler for the same temperature rise ΔT .

Next the Thermal Resistance R_{th} is not a fix value – the nominal value we declare corresponds with a 50°C temperature rise – The table below explains the thermal resistance R_{th} for various dissipated power values.

In this way you can completely predict the temperature you are going to get in your LED luminaire.

Difficulties figuring it out – just let us know and our engineers will do the math for you.

$P_d = P_e \times (1-\eta_L)$			LED Light efficiency, η_L (%)			Heat sink to ambient thermal resistance R_{hs-amb} (°C/W)	Heat sink to ambient temperature rise T_{hs-amb} (°C)
			17%	20%	25%	XSA-305	XSA-305
Dissipated Power P_d (W)	10	Electrical Power P_e (W)	12.0	12.5	13.3	1.3	13
	15		18.1	18.8	20.0	1.2	18
	20		24.1	25.0	26.7	1.15	23
	25		30.1	31.3	33.3	1.08	27
	30		36.1	37.5	40.0	1.07	32
	35		42.2	43.8	46.7	1.03	36
	40		48.2	50.0	53.3	1.0	40
	50		60.2	62.5	66.7	0.98	49
	60		72.3	75.0	80.0	0.95	57

▼ Heat sink to ambient temperature rise T_{hs-amb} (°C)

— XSA-305

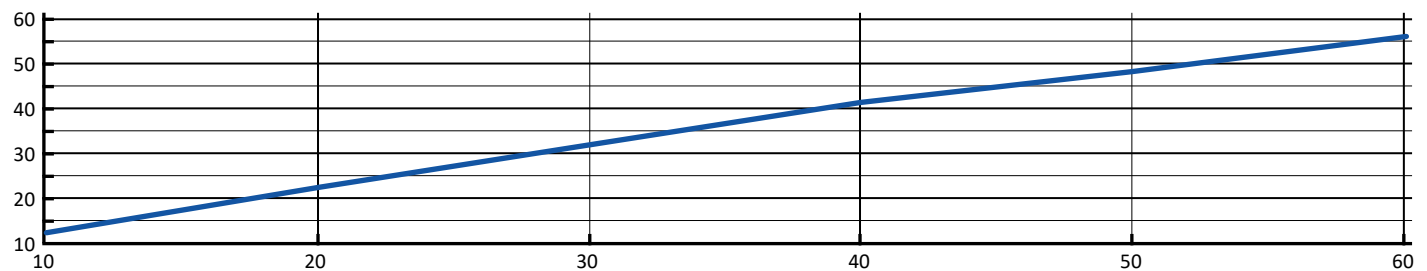

► Dissipated Power P_d (W)