



## IR Receiver Modules for Remote Control Systems



### FEATURES

- Very low supply current
- Photo detector and preamplifier in one package
- Internal filter for PCM frequency
- Supply voltage: 2.5 V to 5.5 V
- Improved immunity against ambient light
- Insensitive to supply voltage ripple and noise
- Material categorization:  
for definitions of compliance please see [www.vishay.com/doc?99912](http://www.vishay.com/doc?99912)



### DESIGN SUPPORT TOOLS

[click logo to get started](#)



### MECHANICAL DATA

#### Pinning for TSOP348.., TSOP344..:

1 = OUT, 2 = GND, 3 = V<sub>S</sub>

#### Pinning for TSOP322.., TSOP324..:

1 = OUT, 2 = V<sub>S</sub>, 3 = GND

### DESCRIPTION

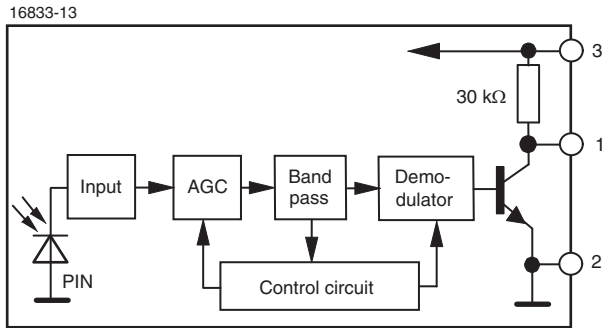
The TSOP322.., TSOP348.., TSOP324.. and TSOP344.. series are miniaturized IR receiver modules for infrared remote control systems. A PIN diode and a preamplifier are assembled on lead frame, the epoxy package contains an IR filter.

The demodulated output signal can be directly connected to a microprocessor for decoding.

The TSOP324.., TSOP344.. series devices are optimized to suppress almost all spurious pulses from energy saving lamps like CFLs. The AGC4 used in the TSOP324.., TSOP344.. may suppress some data signals. The TSOP322.., TSOP348.. series are provided primarily for compatibility with old AGC2 designs. New designs should prefer the TSOP324.., TSOP344.. series containing the newer AGC4.

These components have not been qualified according to automotive specifications.

PARTS TABLE					
AGC		LEGACY, FOR LONG BURST REMOTE CONTROLS (AGC2)		RECOMMENDED FOR LONG BURST CODES (AGC4)	
Carrier frequency	30 kHz	TSOP34830	TSOP32230	TSOP34430	TSOP32430
	33 kHz	TSOP34833	TSOP32233	TSOP34433	TSOP32433
	36 kHz	TSOP34836	TSOP32236	TSOP34436 <sup>(1)(2)(3)</sup>	TSOP32436 <sup>(1)(2)(3)</sup>
	38 kHz	TSOP34838	TSOP32238	TSOP34438 <sup>(4)(5)</sup>	TSOP32438 <sup>(4)(5)</sup>
	40 kHz	TSOP34840	TSOP32240	TSOP34440	TSOP32440
	56 kHz	TSOP34856	TSOP32256	TSOP34456 <sup>(6)(7)</sup>	TSOP32456 <sup>(6)(7)</sup>
Package	Mold				
Pinning	1 = OUT, 2 = GND, 3 = V <sub>S</sub>	1 = OUT, 2 = V <sub>S</sub> , 3 = GND	1 = OUT, 2 = GND, 3 = V <sub>S</sub>	1 = OUT, 2 = V <sub>S</sub> , 3 = GND	
Dimensions (mm)	6.0 W x 6.95 H x 5.6 D				
Mounting	Leaded				
Application	Remote control				
Best choice for	<sup>(1)</sup> RC-5 <sup>(2)</sup> RC-6 <sup>(3)</sup> Panasonic <sup>(4)</sup> NEC <sup>(5)</sup> Sharp <sup>(6)</sup> r-step <sup>(7)</sup> Thomson RCA				

**BLOCK DIAGRAM**

**APPLICATION CIRCUIT**

**ABSOLUTE MAXIMUM RATINGS**

PARAMETER	TEST CONDITION	SYMBOL	VALUE	UNIT
Supply voltage		$V_S$	-0.3 to +6	V
Supply current		$I_S$	3	mA
Output voltage		$V_O$	-0.3 to $(V_S + 0.3)$	V
Output current		$I_O$	5	mA
Junction temperature		$T_j$	100	°C
Storage temperature range		$T_{stg}$	-25 to +85	°C
Operating temperature range		$T_{amb}$	-25 to +85	°C
Power consumption	$T_{amb} \leq 85\text{ °C}$	$P_{tot}$	10	mW
Soldering temperature	$t \leq 10\text{ s}$ , 1 mm from case	$T_{sd}$	260	°C

**Note**

- Stresses beyond those listed under “Absolute Maximum Ratings” may cause permanent damage to the device. This is a stress rating only and functional operation of the device at these or any other conditions beyond those indicated in the operational sections of this specification is not implied. Exposure to absolute maximum rating conditions for extended periods may affect the device reliability

**ELECTRICAL AND OPTICAL CHARACTERISTICS** ( $T_{amb} = 25\text{ °C}$ , unless otherwise specified)

PARAMETER	TEST CONDITION	SYMBOL	MIN.	TYP.	MAX.	UNIT
Supply current	$E_v = 0$ , $V_S = 3.3\text{ V}$	$I_{SD}$	0.27	0.35	0.45	mA
	$E_v = 40\text{ klx}$ , sunlight	$I_{SH}$	-	0.45	-	mA
Supply voltage		$V_S$	2.5	-	5.5	V
Transmission distance	$E_v = 0$ , test signal see Fig. 1, IR diode TSAL6200, $I_F = 150\text{ mA}$	$d$	-	45	-	m
Output voltage low	$I_{OSL} = 0.5\text{ mA}$ , $E_e = 0.7\text{ mW/m}^2$ , test signal see Fig. 1	$V_{OSL}$	-	-	100	mV
Minimum irradiance	Pulse width tolerance: $t_{pi} - 5/f_0 < t_{po} < t_{pi} + 6/f_0$ , test signal see Fig. 1	$E_e\text{ min.}$	-	0.08	0.15	$\text{mW/m}^2$
Maximum irradiance	$t_{pi} - 5/f_0 < t_{po} < t_{pi} + 6/f_0$ , test signal see Fig. 1	$E_e\text{ max.}$	30	-	-	$\text{W/m}^2$
Directivity	Angle of half transmission distance	$\phi_{1/2}$	-	$\pm 45$	-	deg

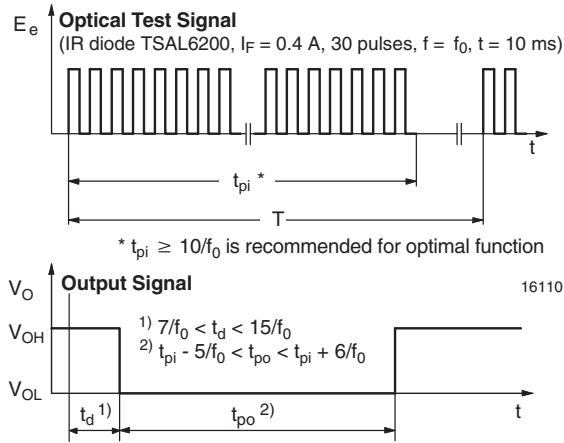
**TYPICAL CHARACTERISTICS** ( $T_{amb} = 25\text{ }^{\circ}\text{C}$ , unless otherwise specified)


Fig. 1 - Output Active Low

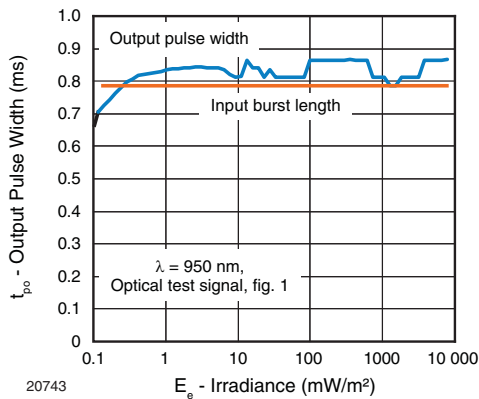


Fig. 2 - Pulse Length and Sensitivity in Dark Ambient

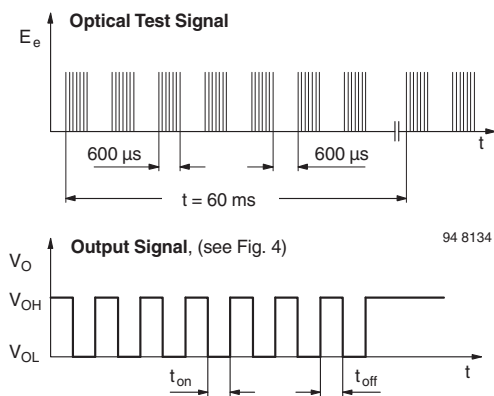


Fig. 3 - Output Function

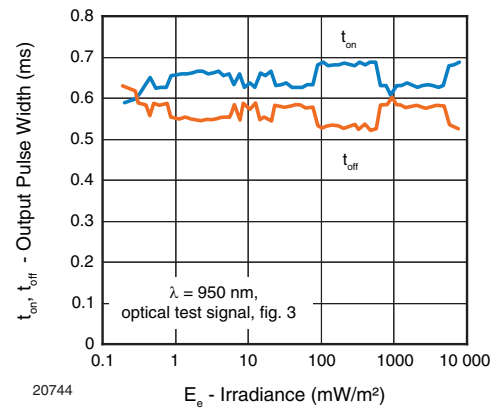


Fig. 4 - Output Pulse Diagram

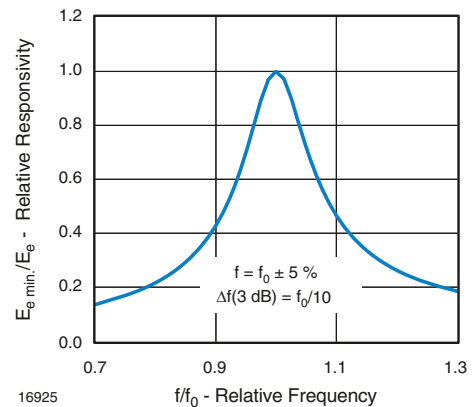


Fig. 5 - Frequency Dependence of Responsivity

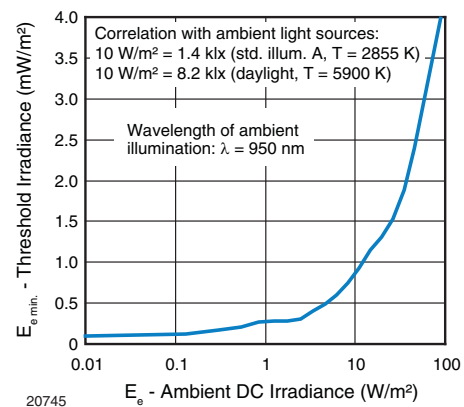


Fig. 6 - Sensitivity in Bright Ambient

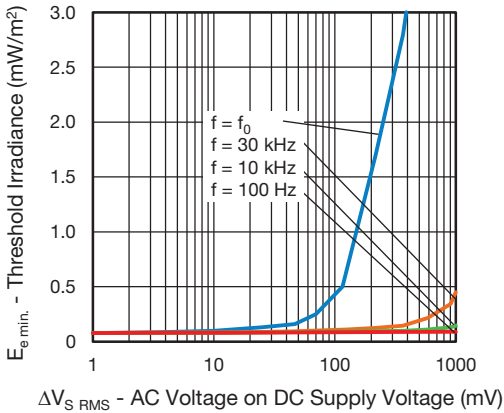


Fig. 7 - Sensitivity vs. Supply Voltage Disturbances

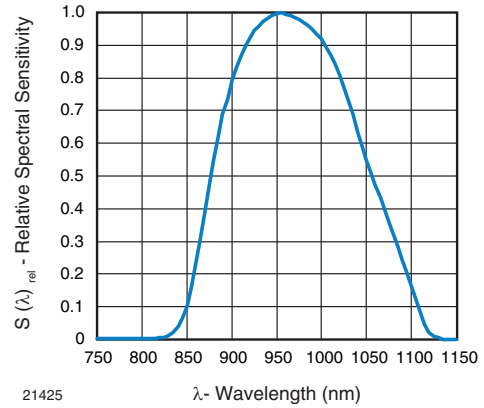


Fig. 10 - Relative Spectral Sensitivity vs. Wavelength

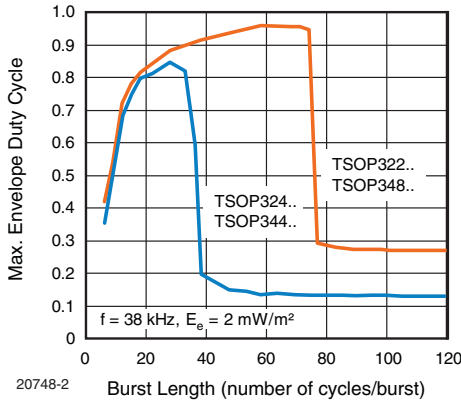


Fig. 8 - Max. Envelope Duty Cycle vs. Burst Length

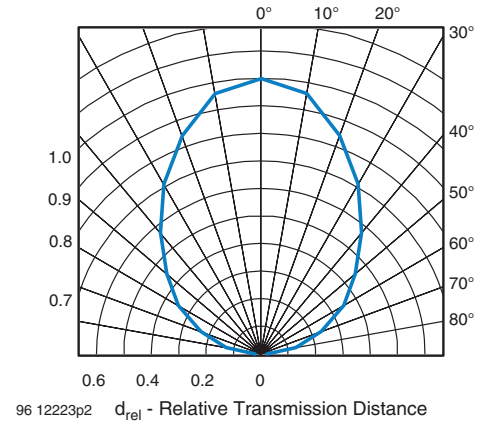


Fig. 11 - Horizontal Directivity

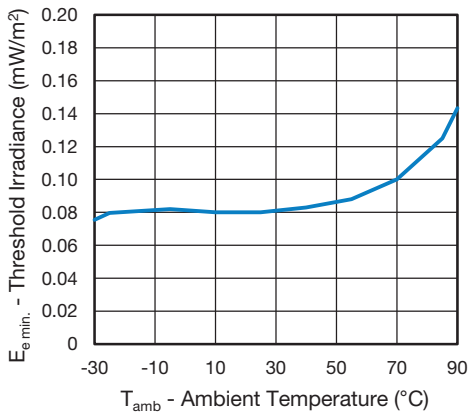


Fig. 9 - Sensitivity vs. Ambient Temperature

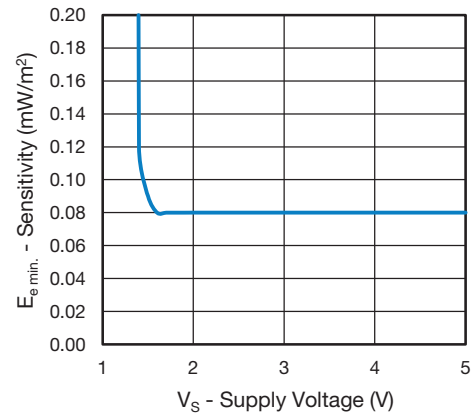


Fig. 12 - Sensitivity vs. Supply Voltage

## SUITABLE DATA FORMAT

This series is designed to suppress spurious output pulses due to noise or disturbance signals. The devices can distinguish data signals from noise due to differences in frequency, burst length, and envelope duty cycle. The data signal should be close to the device's band-pass center frequency (e.g. 38 kHz) and fulfill the conditions in the table below.

When a data signal is applied to the product in the presence of a disturbance, the sensitivity of the receiver is automatically reduced by the AGC to insure that no spurious pulses are present at the receiver's output. Some examples which are suppressed are:

- DC light (e.g. from tungsten bulbs sunlight)
- Continuous signals at any frequency
- Strongly or weakly modulated patterns from fluorescent lamps with electronic ballasts (see Fig. 13 or Fig. 14).

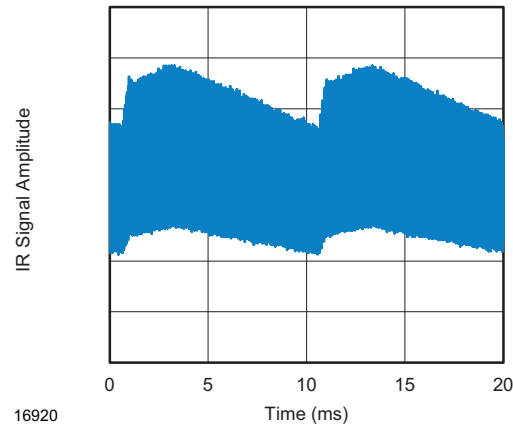


Fig. 13 - IR Disturbance from Fluorescent Lamp With Low Modulation

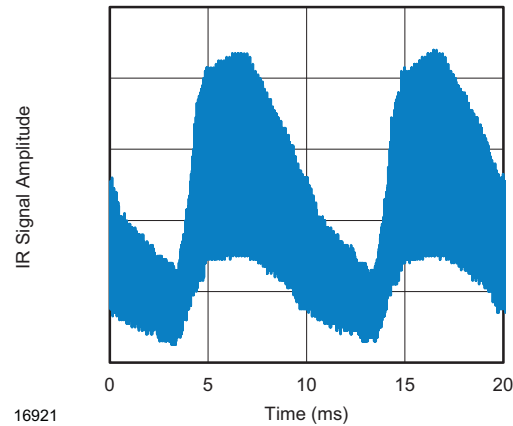


Fig. 14 - IR Disturbance from Fluorescent Lamp With High Modulation

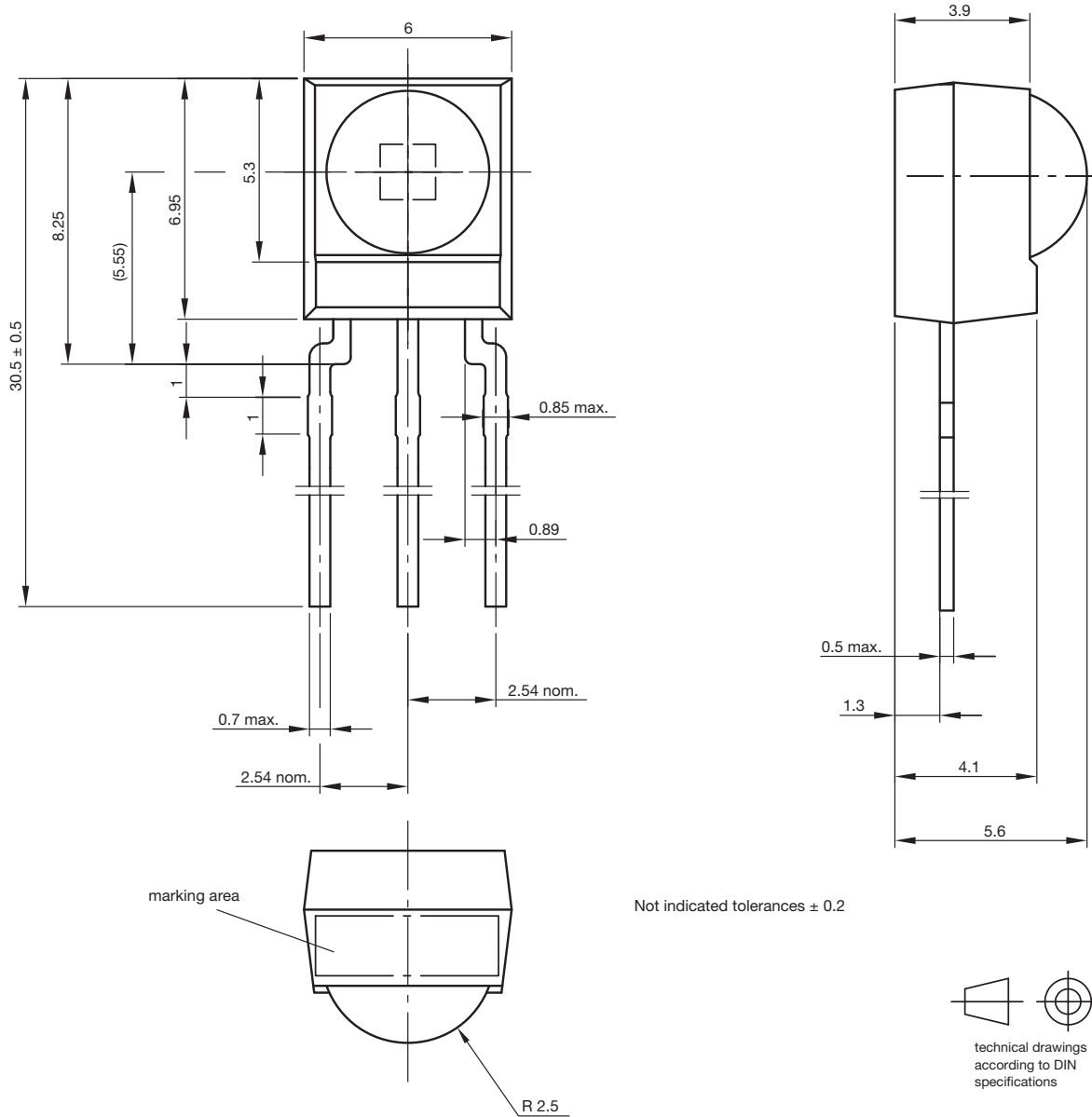
	TSOP322.., TSOP348..	TSOP324.., TSOP344..
Minimum burst length	10 cycles/burst	10 cycles/burst
After each burst of length a minimum gap time is required of	10 to 70 cycles ≥ 10 cycles	10 to 35 cycles ≥ 10 cycles
For bursts greater than a minimum gap time in the data stream is needed of	70 cycles > 4 x burst length	35 cycles > 10 x burst length
Maximum number of continuous short bursts/second	1800	1500
NEC code	Yes	Preferred
RC5/RC6 code	Yes	Preferred
Thomson 56 kHz code	Yes	Preferred
Sharp code	Yes	Preferred
Suppression of interference from fluorescent lamps	Mild disturbance patterns are suppressed (example: signal pattern of Fig. 13)	Complex and critical disturbance patterns are suppressed (example: signal pattern of Fig. 14 or highly dimmed LCDs)

### Notes

- For data formats with short bursts please see the datasheet for TSOP323.., TSOP325.., TSOP343.., TSOP345..
- For Sony 12, 15, and 20 bit IR codes please see the datasheet of TSOP34S40F, TSOP32S40F



## PACKAGE DIMENSIONS in millimeters



Drawing-No.: 6.550-5169.01-4  
Issue: 9; 03.11.10  
13655



## **Disclaimer**

ALL PRODUCT, PRODUCT SPECIFICATIONS AND DATA ARE SUBJECT TO CHANGE WITHOUT NOTICE TO IMPROVE RELIABILITY, FUNCTION OR DESIGN OR OTHERWISE.

Vishay Intertechnology, Inc., its affiliates, agents, and employees, and all persons acting on its or their behalf (collectively, "Vishay"), disclaim any and all liability for any errors, inaccuracies or incompleteness contained in any datasheet or in any other disclosure relating to any product.

Vishay makes no warranty, representation or guarantee regarding the suitability of the products for any particular purpose or the continuing production of any product. To the maximum extent permitted by applicable law, Vishay disclaims (i) any and all liability arising out of the application or use of any product, (ii) any and all liability, including without limitation special, consequential or incidental damages, and (iii) any and all implied warranties, including warranties of fitness for particular purpose, non-infringement and merchantability.

Statements regarding the suitability of products for certain types of applications are based on Vishay's knowledge of typical requirements that are often placed on Vishay products in generic applications. Such statements are not binding statements about the suitability of products for a particular application. It is the customer's responsibility to validate that a particular product with the properties described in the product specification is suitable for use in a particular application. Parameters provided in datasheets and / or specifications may vary in different applications and performance may vary over time. All operating parameters, including typical parameters, must be validated for each customer application by the customer's technical experts. Product specifications do not expand or otherwise modify Vishay's terms and conditions of purchase, including but not limited to the warranty expressed therein.

Except as expressly indicated in writing, Vishay products are not designed for use in medical, life-saving, or life-sustaining applications or for any other application in which the failure of the Vishay product could result in personal injury or death. Customers using or selling Vishay products not expressly indicated for use in such applications do so at their own risk. Please contact authorized Vishay personnel to obtain written terms and conditions regarding products designed for such applications.

No license, express or implied, by estoppel or otherwise, to any intellectual property rights is granted by this document or by any conduct of Vishay. Product names and markings noted herein may be trademarks of their respective owners.