

NFM3DCC222R1H3#

"#" indicates a package specification code.



< List of part numbers with package codes >
NFM3DCC222R1H3L

Shape

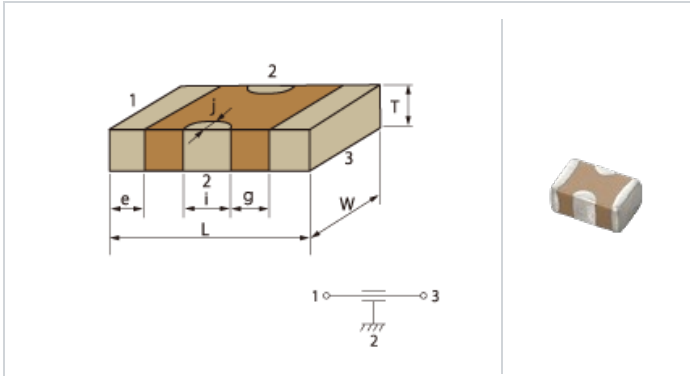

L size	3.2 ±0.2mm
W size	1.25 ±0.2mm
T size	0.7 ±0.2mm
External terminal width e	0.3±0.2mm
External terminal size i	1.1±0.3mm
External terminal size j	0.25±0.2mm
Distance between external terminals g	0.4mm min.
Size code in inch(mm)	1205 (3212M)

References

Packaging	Specifications	Minimum quantity
L	φ 180mm Embossed taping	4000

Mass (typ.)	
1 piece	18mg
φ 180mm Reel	121g

Specifications

Capacitance	2200pF +50/-20%
Rated voltage	50Vdc
Operating temperature range	-55 to 125°C
Rated Current	300mA
DC Resistance(max.)	300mΩ

⚠ Attention

- 1.This datasheet is downloaded from the website of Murata Manufacturing Co., Ltd. Therefore, it's specifications are subject to change or our products in it may be discontinued without advance notice. Please check with our sales representatives or product engineers before ordering.
- 2.This datasheet has only typical specifications because there is no space for detailed specifications. Therefore, please review our product specifications or consult the approval sheet for product specifications before ordering.