



**SEMIPACK® 1**

## Rectifier Diode Modules

### SKKD 101/16

#### Features

- Heat transfer through aluminium oxide ceramic isolated metal baseplate
- UL recognized, file no. E63532

#### Typical Applications\*

- Non-controllable rectifiers for AC/AC converters
- Line rectifiers for transistorized AC motor controllers
- Field supply for DC motors

Absolute Maximum Ratings				
Symbol	Conditions		Values	Unit
<b>Rectifier Diode</b>				
$I_{FAV}$	sin. 180°	$T_c = 85\text{ °C}$	134	A
		$T_c = 100\text{ °C}$	101	A
$I_{FRMS}$	continuous operation		210	A
$I_{FSM}$	10 ms	$T_j = 25\text{ °C}$	2500	A
		$T_j = 130\text{ °C}$	2000	A
$i^2t$	10 ms	$T_j = 25\text{ °C}$	31250	A <sup>2</sup> s
		$T_j = 130\text{ °C}$	20000	A <sup>2</sup> s
$V_{RSM}$			1700	V
$V_{RRM}$			1600	V
$T_j$			-40 ... 130	°C
<b>Module</b>				
$T_{stg}$			-40 ... 125	°C
$V_{isol}$	a.c.; 50 Hz; r.m.s.	1 min	3000	V
		1 s	3600	V

Characteristics						
Symbol	Conditions		min.	typ.	max.	Unit
<b>Diode</b>						
$V_F$	$T_j = 25\text{ °C}, I_F = 300\text{ A}$		1.45	1.60		V
$V_{(TO)}$	$T_j = 130\text{ °C}$		0.75	0.87		V
$r_T$	$T_j = 130\text{ °C}$		2.20	2.45		mΩ
$I_{RD}$	$T_j = 130\text{ °C}, V_{RRM}$				3	mA
$R_{th(j-c)}$	cont.	per chip			0.19	K/W
		per module			0.095	K/W
$R_{th(j-c)}$	sin. 180°	per chip			0.2	K/W
		per module			0.1	K/W
<b>Module</b>						
$R_{th(c-s)}$	chip			0.22		K/W
	module			0.11		K/W
$M_s$	to heatsink M5		4.25		5.75	Nm
$M_t$	to terminals M5		2.55		3.45	Nm
$a$					5 * 9,81	m/s <sup>2</sup>
$w$				75		g

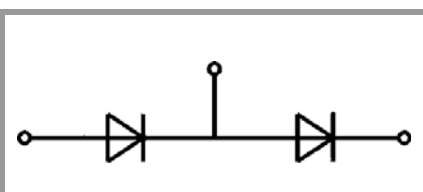

**SKKD**

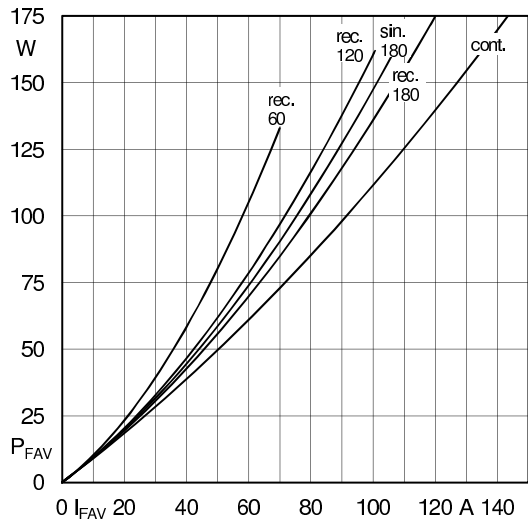

Fig. 11L: Power dissipation per diode vs. forward current

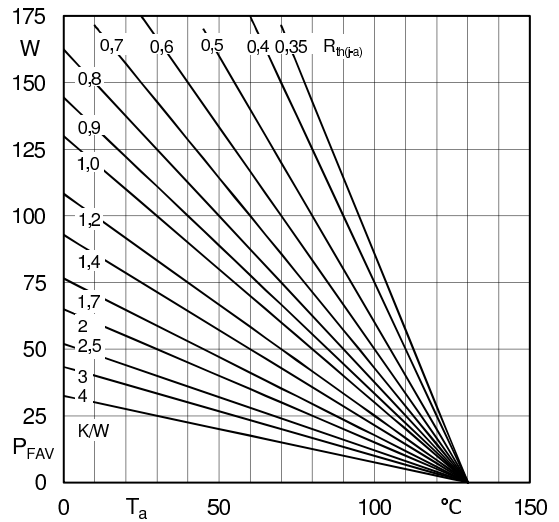

Fig. 11R: Power dissipation per diode vs. ambient temperature

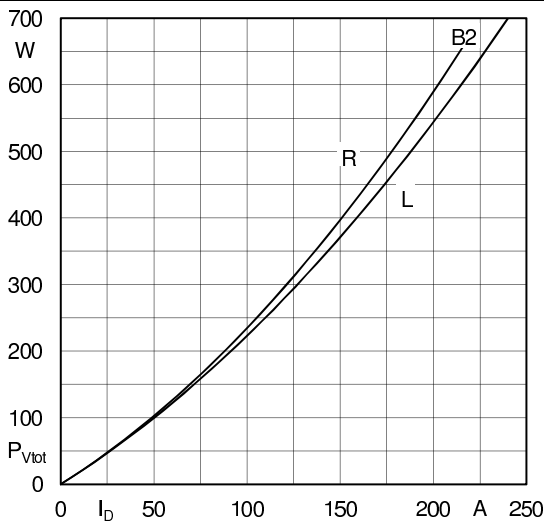

Fig. 12L: Power dissipation of two modules vs. direct current

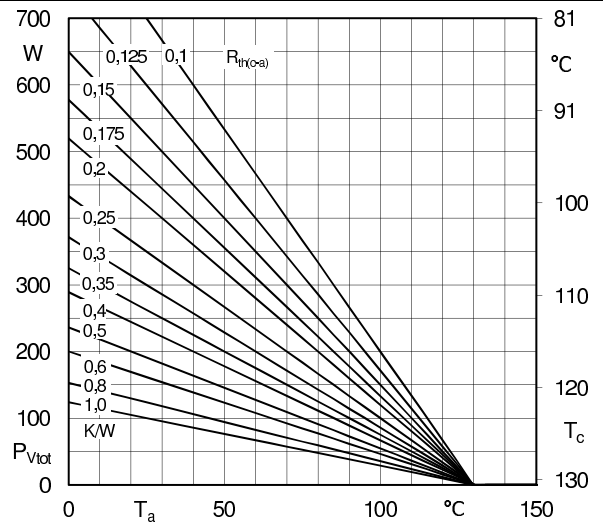

Fig. 12R: Power dissipation of two modules vs. case temperature

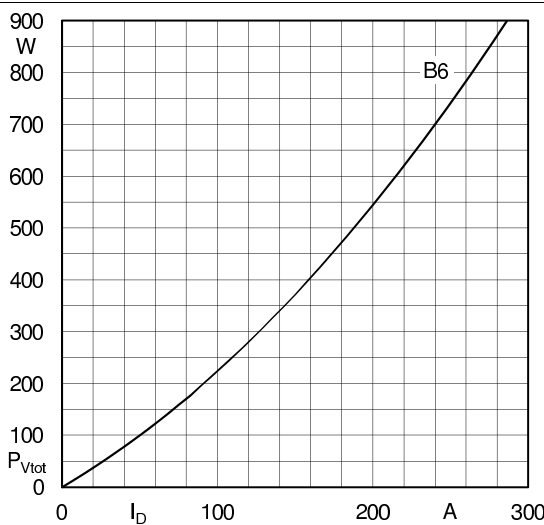

Fig. 13L: Power dissipation of three modules vs. direct current

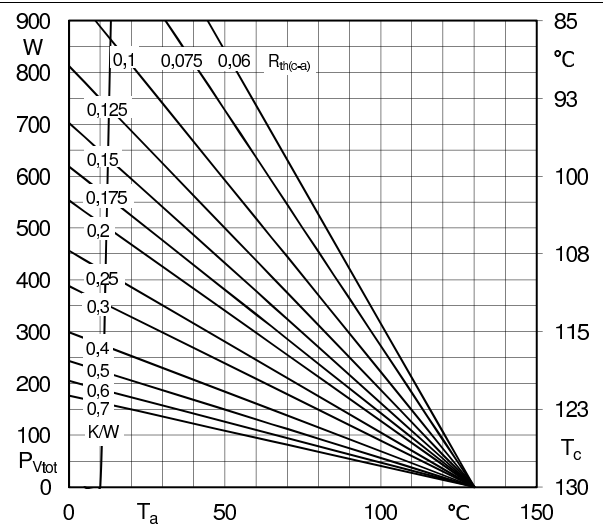

Fig. 13R: Power dissipation of three modules vs. case temperature

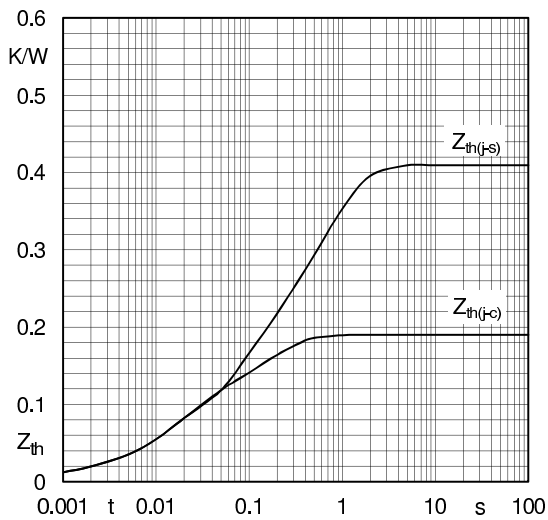

Fig. 14: Transient thermal impedance vs. time

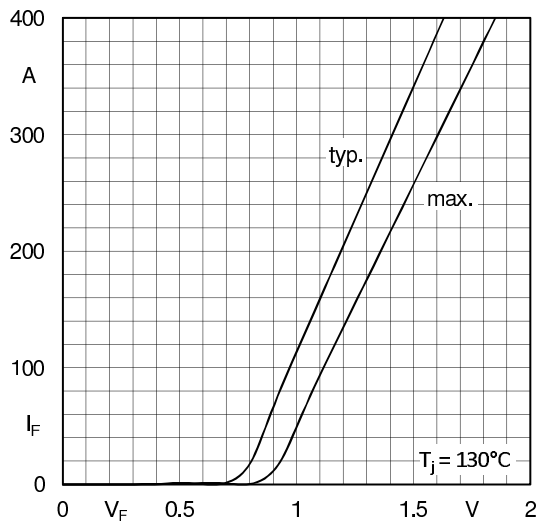

Fig. 15: Forward characteristics

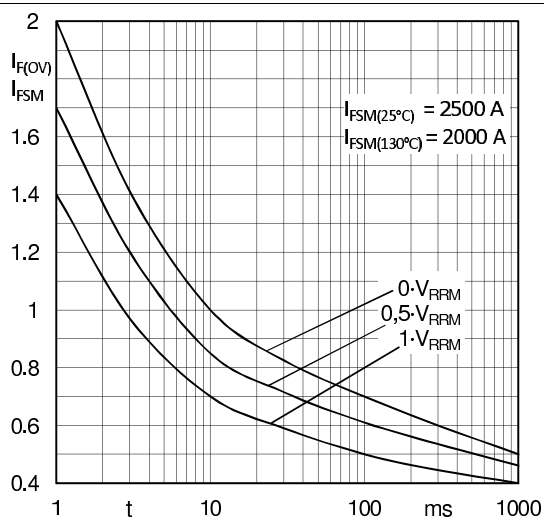
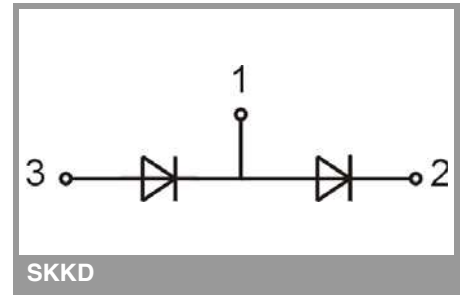
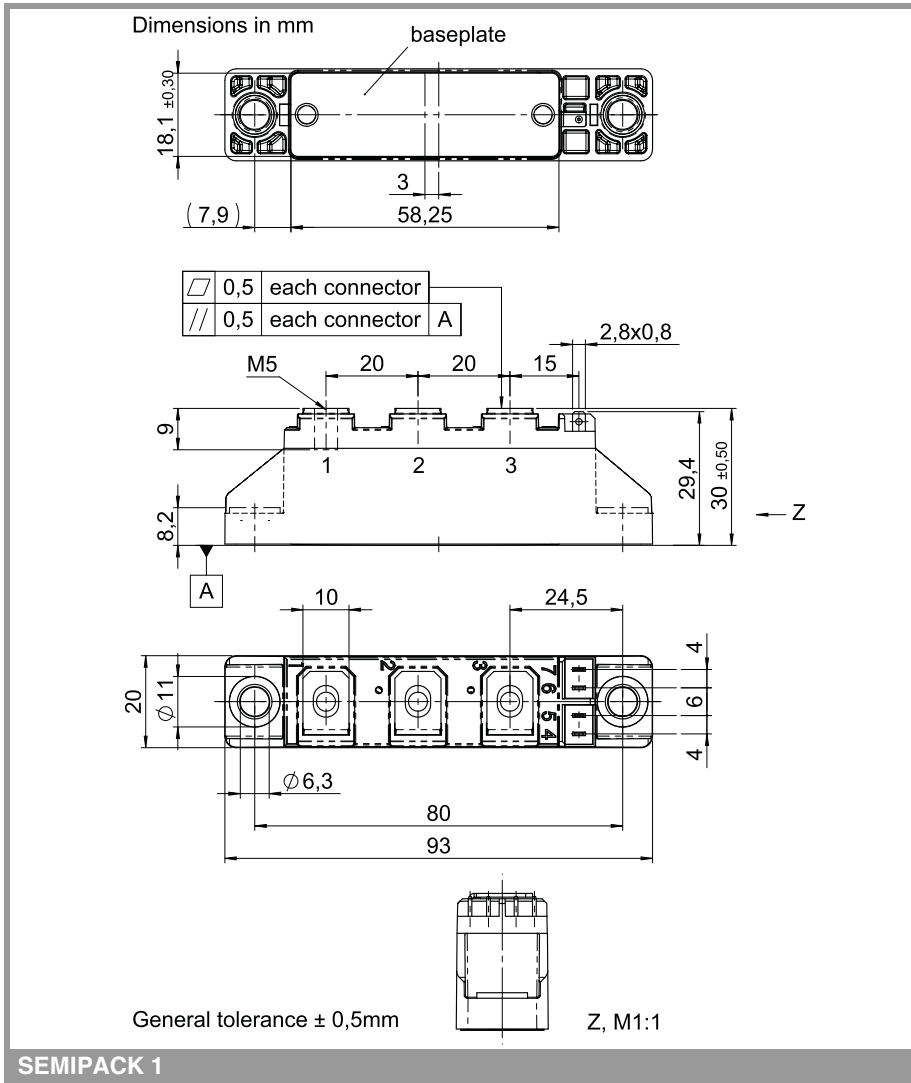

Fig. 16: Surge overload current vs. time



This is an electrostatic discharge sensitive device (ESDS), international standard IEC 60747-1, chapter IX.

### \*IMPORTANT INFORMATION AND WARNINGS

The specifications of SEMIKRON products may not be considered as guarantee or assurance of product characteristics ("Beschaffenheitsgarantie"). The specifications of SEMIKRON products describe only the usual characteristics of products to be expected in typical applications, which may still vary depending on the specific application. Therefore, products must be tested for the respective application in advance. Application adjustments may be necessary. The user of SEMIKRON products is responsible for the safety of their applications embedding SEMIKRON products and must take adequate safety measures to prevent the applications from causing a physical injury, fire or other problem if any of SEMIKRON products become faulty. The user is responsible to make sure that the application design is compliant with all applicable laws, regulations, norms and standards. Except as otherwise explicitly approved by SEMIKRON in a written document signed by authorized representatives of SEMIKRON, SEMIKRON products may not be used in any applications where a failure of the product or any consequences of the use thereof can reasonably be expected to result in personal injury. No representation or warranty is given and no liability is assumed with respect to the accuracy, completeness and/or use of any information herein, including without limitation, warranties of non-infringement of intellectual property rights of any third party. SEMIKRON does not assume any liability arising out of the applications or use of any product; neither does it convey any license under its patent rights, copyrights, trade secrets or other intellectual property rights, nor the rights of others. SEMIKRON makes no representation or warranty of non-infringement or alleged non-infringement of intellectual property rights of any third party which may arise from applications. Due to technical requirements our products may contain dangerous substances. For information on the types in question please contact the nearest SEMIKRON sales office. This document supersedes and replaces all information previously supplied and may be superseded by updates. SEMIKRON reserves the right to make changes.