

# RMP84

## miniature relays

version AC



version DC



- Cadmium - free contacts • Height 25,5 mm
- 5000 V / 8 mm reinforced insulation
- For plug-in sockets
- Accessories: sockets and modules
- AC and DC coils
- WT (mechanical indicator + lockable front test button)
- standard features of relays
- Recognitions, certifications, directives: RoHS,

### Contact data

Number and type of contacts		2 CO
Contact material		<b>AgNi</b>
Rated / max. switching voltage	AC	250 V / 440 V
Min. switching voltage		12 V 10 mA
Rated load	AC1	8 A / 250 V AC
Min. switching current		10 mA 12 V
Max. inrush current		16 A 20 ms
Rated current		8 A
Max. breaking capacity	AC1	2 000 VA
Min. breaking capacity		0,12 W 10 mA / 12 V
Contact resistance		≤ 100 mΩ 1 A / 6 V DC
Max. operating frequency		
• at rated load	AC1	360 cycles/hour
• no load		18 000 cycles/hour

### Coil data

Rated voltage	50 Hz AC	<b>24</b> , 115, <b>230</b> V
	DC	<b>12</b> , <b>24</b> , 48, 110 V
Must release voltage		AC: ≥ 0,15 U <sub>n</sub> DC: ≥ 0,1 U <sub>n</sub>
Operating range of supply voltage		see Tables 1, 2
Rated power consumption	AC	0,75 VA
	DC	0,4 ... 0,48 W

### Insulation according to EN 60664-1

Insulation rated voltage		440 V AC
Rated surge voltage		4 000 V 1,2 / 50 μs
Overvoltage category		III
Insulation pollution degree		3
Insulation resistance		1 000 MΩ 500 V DC
Dielectric strength		
• between coil and contacts		5 000 V AC type of insulation: reinforced
• contact clearance		1 000 V AC type of clearance: micro-disconnection
• pole - pole		2 500 V AC type of insulation: basic
Contact - coil distance		
• clearance		≥ 8 mm
• creepage		≥ 8 mm

### General data

Operating / release time (typical values)		15 ms / 8 ms
Electrical life	• resistive AC1	
(number of cycles)		> 3 x 10 <sup>4</sup> AC coils, 8 A, 250 V AC, ON for 5 s / OFF for 5 s
		> 10 <sup>4</sup> DC coils, 8 A, 250 V AC, ON for 5 s / OFF for 5 s
		> 5 x 10 <sup>4</sup> 8 A, 250 V AC, 70 °C, ON for 1 s / OFF for 9 s
Mechanical life (cycles)		> 10 <sup>6</sup> AC coils
		> 5 x 10 <sup>6</sup> DC coils
Dimensions (L x W x H)		29 x 13 x 25,5 mm
Weight		16 g
Ambient temperature	• storage	-40...+70 °C
(non-condensation and/or icing)	• operating	-40...+70 °C
Cover protection category		IP 40 EN 60529
Environmental protection		RTII EN 61810-7
Relative humidity		5...85%
Shock resistance		10 g
Vibration resistance	(NO/NC)	10 g / 5 g length direction: 10 g / 2 g  10...150 Hz
Solder bath temperature		max. 270 °C
Soldering time		max. 5 s

The data in bold type relate to the standard versions of the relays. The data don't include the power of electronic indicating circuit when the relay picks-up. Operating temperature for relays mounted in sockets on 35 mm rail mount: -40...+55 °C. The distance between the relays mounted side by side: min. 5 mm for versions AC; min. 1,5 mm for versions DC.

# RMP84

## miniature relays

### Dimensions

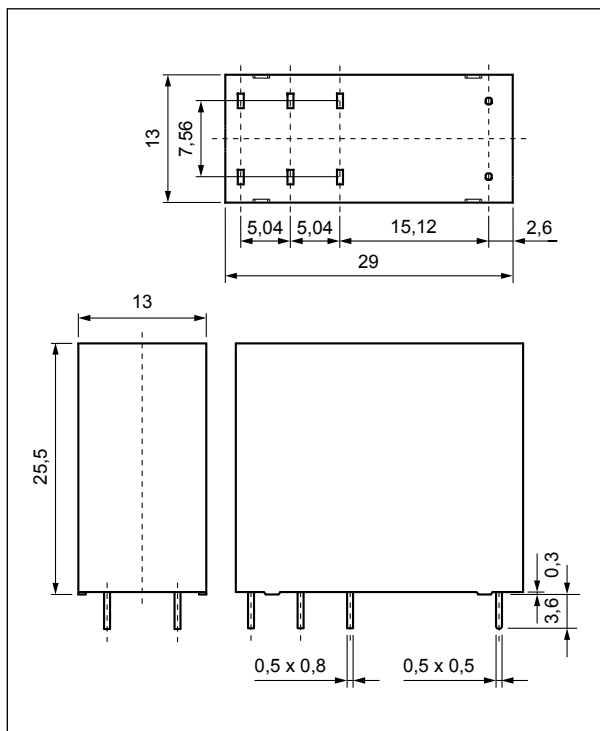

### Connection diagram (pin side view)

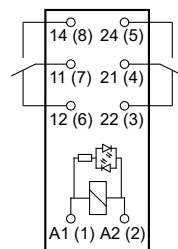

2 CO

Terminal (pin)	A1(1); A2(2)	22(3); 21(4); 24(5); 12(6); 11(7); 14(8)
[mm]	0,5 x 0,5	0,5 x 0,8
Drilling hole:	• for sockets $\varnothing 1,5 + 0,1$ mm	

### Test buttons type T



**orange**  
– AC coils

**blue**  
– DC coils

**Note:** Normally open contacts may be closed with the blocking function of the test button of the T type (it shall be bent by 90° to vertical position). When the button is drawn back, the normally open contacts are opened.

### GZF80, GZMB80, EC 50, GD50

Plug-in sockets  
for relays  
RMP84, RMP85  
- see pages 5-6

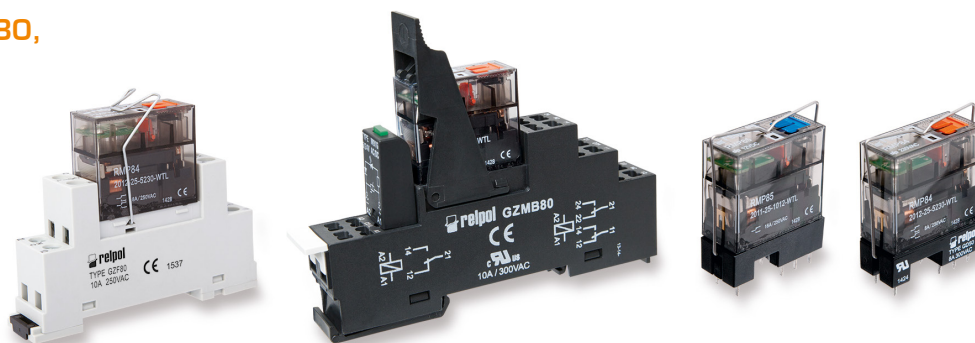

**Electrical life at AC resistive load.**  
Switching frequency: 360 cycles/hour

Fig. 1

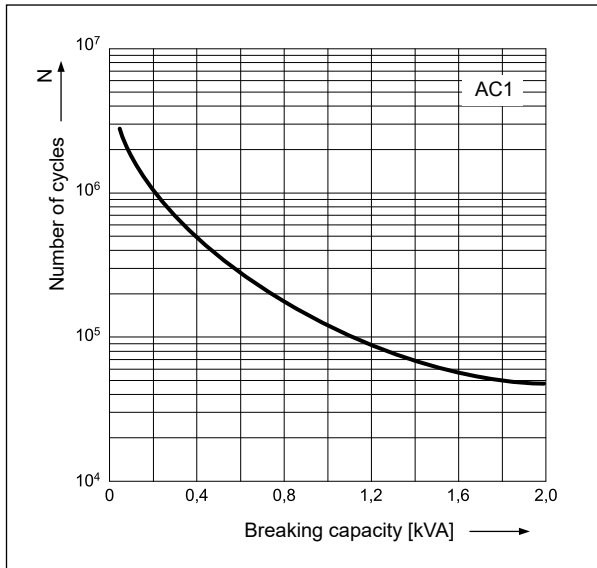

**Max. AC 50 Hz resistive load breaking capacity**

Fig. 2

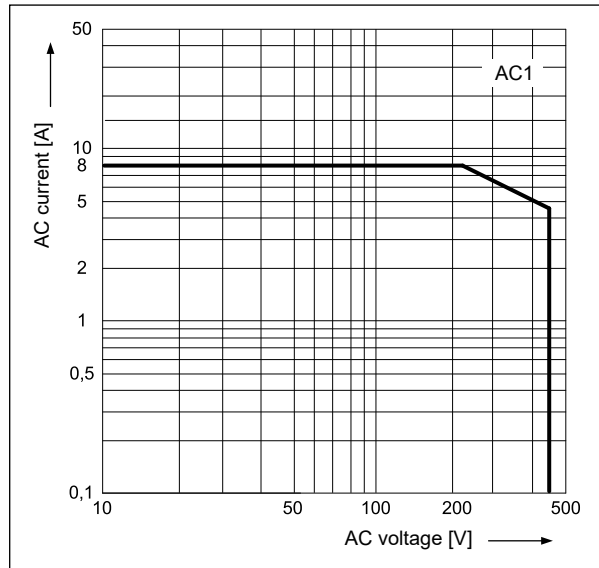

## Mounting, sockets and accessories for relays

Relays **RMP84** ④ are designed for mounting in plug-in sockets.

Sockets for RMP84	Accessories			Additional features
	Retainer / retractor clips	Spring wire clips	Description plates	
<b>Screw terminals sockets</b> , 35 mm rail mount (acc. to EN 60715) or on panel mounting (one M3 screw)				
GZF80	–	GZ80-1001	–	–
<b>Spring terminals sockets</b> , 35 mm rail mount (acc. to EN 60715)				
GZMB80 ④	GZMB80-0025	GZM80-0025	TR	modules ⑤
<b>Sockets for PCB</b>				
EC 50	–	MH25-2	–	–
GD50	–	MH25-2	–	–

④ The distance between the relays mounted side by side: min. 5 mm for versions AC; min. 1,5 mm for versions DC.

⑤ Sockets GZMB80: wire connection - see page 5.

⑥ Signalling / protecting modules type M... - see page 7.

# RMP84

## miniature relays

**Coil data - DC voltage version**

Table 1

Coil code	Rated voltage V DC	Coil resistance at 23 °C Ω	Acceptable resistance	Coil operating range V DC ⑥	
				min. (0...+70 °C)	max. (0...+70 °C)
<b>1012</b>	<b>12</b>	<b>360</b>	<b>± 10%</b>	<b>8,4</b>	<b>18,0</b>
<b>1024</b>	<b>24</b>	<b>1 440</b>	<b>± 10%</b>	<b>16,8</b>	<b>36,0</b>
1048	48	5 760	± 15%	33,6	72,0
1110	110	25 200	± 15%	77,0	165,0

The data in bold type relate to the standard versions of the relays. ⑥ The max. allowable voltage is coil overdrive voltage, it is the instantaneous max. voltage which the relay coil could endure in very short time. Relays with 48 V DC and 110 V DC coils shall be absolutely protected against any possibility of operation at voltages higher than the rated voltage.

**Coil data - AC 50 Hz voltage version**

Table 2

Coil code	Rated voltage V AC	Coil resistance at 23 °C Ω	Acceptable resistance	Coil operating range V AC 50 Hz	
				min. (0...+70 °C)	max. (0...+70 °C)
<b>5024</b>	<b>24</b>	<b>350</b>	<b>± 10%</b>	<b>18,0</b>	<b>26,4</b>
5115	115	8 100	± 15%	86,3	126,5
<b>5230</b>	<b>230</b>	<b>32 500</b>	<b>± 15%</b>	<b>172,5</b>	<b>253,0</b>

The data in bold type relate to the standard versions of the relays.

### Ordering codes

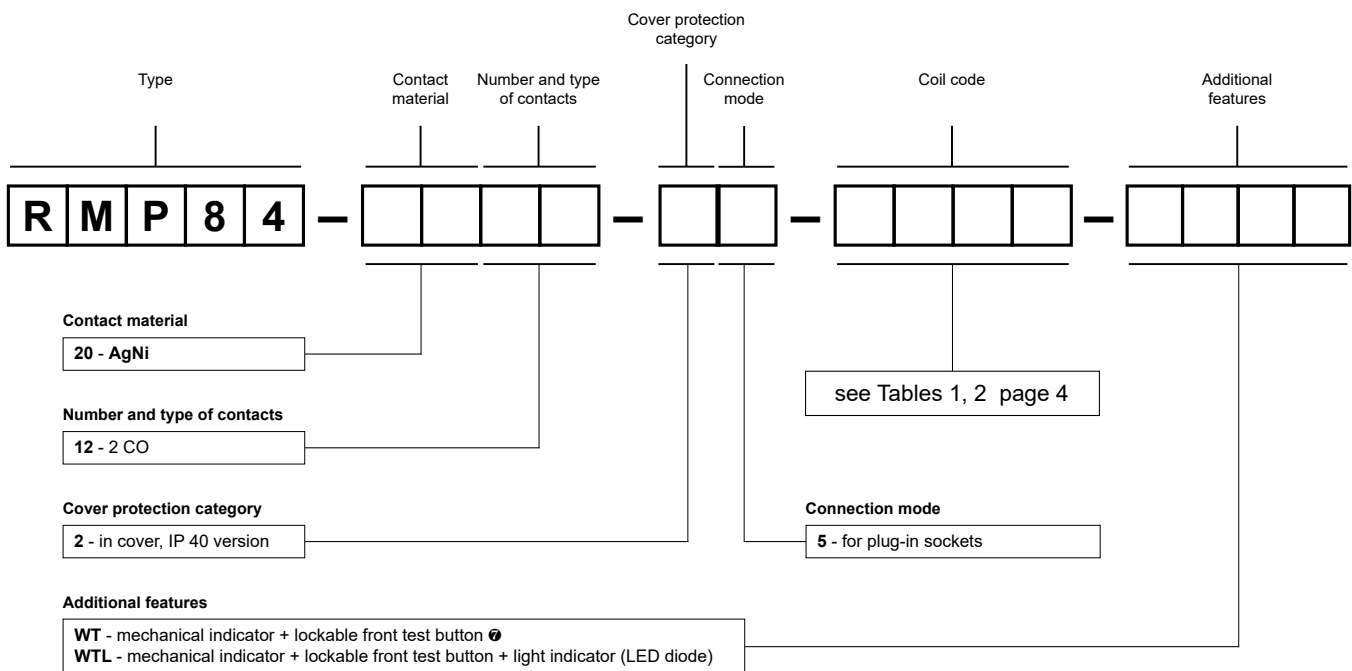

⑦ WT - standard features of relays. Test buttons type T - see page 2.

Examples of ordering code:

**RMP84-2012-25-1024-WT**

relay **RMP84**, for plug-in sockets, two changeover contacts, contact material AgNi, coil voltage 24 V DC, with mechanical indicator and lockable front test button, in cover IP 40

**RMP84-2012-25-5230-WTL**

relay **RMP84**, for plug-in sockets, two changeover contacts, contact material AgNi, coil voltage 230 V AC 50 Hz, with mechanical indicator and lockable front test button and light indicator (LED diode), in cover IP 40

# Plug-in sockets and accessories

## GZF80

For RM84, RM85, RM85 inrush, RM85 105 °C sensitive, RM87L, RM87L sensitive, RM87P, RM87P sensitive, RMP84, RMP85

Screw terminals  
Max. tightening moment for the terminal: 0,5 Nm  
35 mm rail mount  
acc. to EN 60715  
or on panel mounting  
67,2 x 15,5 x 36,5 mm  
Two poles, 5 mm pinout  
10 A, 250 V AC

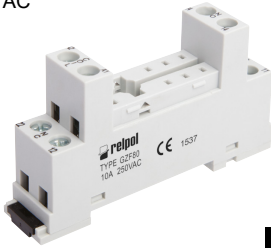

### Connection diagrams ③

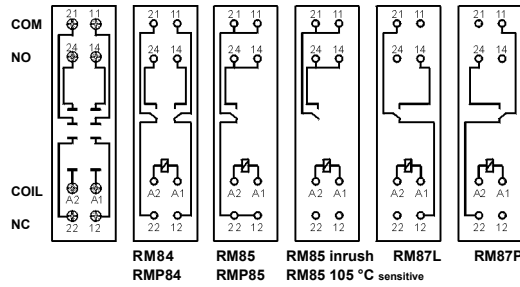

### Dimensions

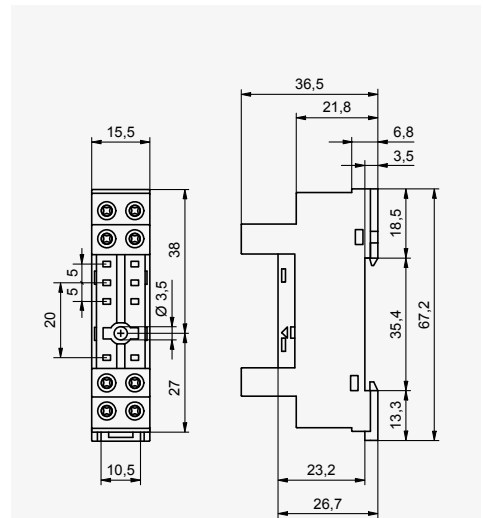

### Accessories ①

GZM80-0041 GZ80-1001

## GZMB80

For RM84, RM85, RM85 inrush, RM85 105 °C sensitive, RM87L, RM87L sensitive, RM87P, RM87P sensitive, RMP84, RMP85

Spring terminals  
Max. cross section of the cables:  
1 x 0,2...1,5 mm<sup>2</sup>  
(1 x 24...16 AWG)  
Stripping length: 9...11 mm

35 mm rail mount  
acc. to EN 60715  
97 x 16 x 45,2(69/78 ④) mm ②  
Two poles, 5 mm pinout  
10 A, 300 V AC

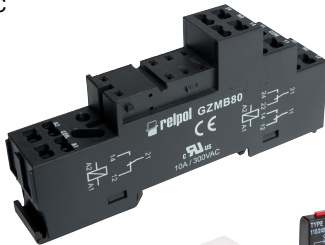

### Connection diagrams ③

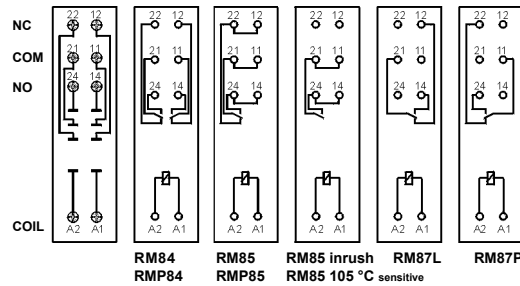

### Dimensions

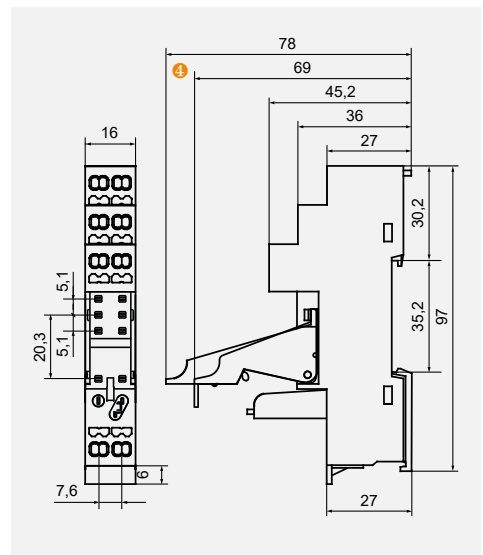

The drawings present the sequence of operations in course of inserting wires to the spring terminal, and the recommended screwdriver to be used for opening of case springs, comply with the DIN 5264 FORM "A".

### Wire connection

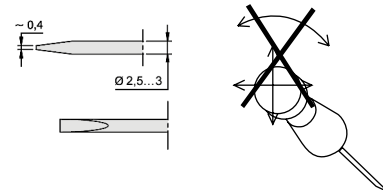

① Mounting and sub-assemblies of accessories in the socket - see page 6. Signalling / protecting modules type M... - see page 7. ② In the bracket the height of socket with retainer / retractor clip is shown. ③ For RM85..., RMP85: loads above 12 A (GZT80, GZM80) or 10 A (GZS80, GZF80, GZMB80) require bridging pairs of terminals: 11 with 21, 12 with 22, 14 with 24 - see catalog "Relays" and www.repol.com.pl ④ Height of set: 69 mm (GZMB80-0040) or 78 mm (GZMB80-0025).

### PRECAUTIONS:

1. Ensure that the parameters of the product described in its specification provide a safety margin for the appropriate operation of the device or system and never use the product in circumstances which exceed the parameters of the product. 2. Never touch any live parts of the device. 3. Ensure that the product has been connected correctly. An incorrect connection may cause malfunction, excessive heating or risk of fire. 4. In case of any risk of any serious material loss or death or injuries of humans or animals, the devices or systems shall be designed so to equip them with double safety system to guarantee their reliable operation.



## Mounting and sub-assemblies of the relay and accessories in the socket

Retainer / retractor clip

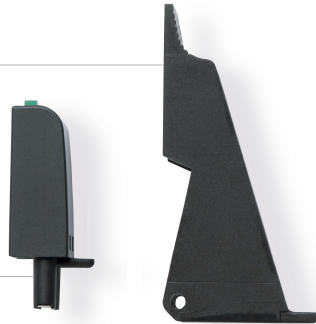

Signalling / protecting module type M...



Electromagnetic relay

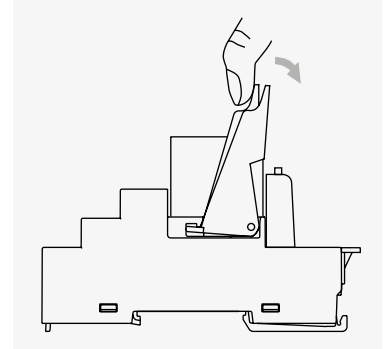

Removing the relay from the socket with a retractor / retractor clip

Description plate



Spring terminals plug-in socket

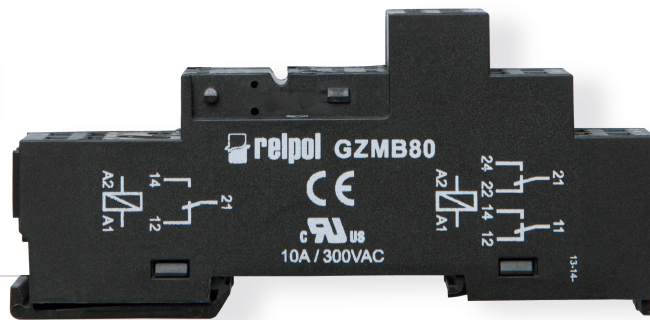

### EC 50

For RM84, RM85, RM85 inrush, RM85 105 °C sensitive, RM87L, RM87L sensitive, RM87P, RM87P sensitive, RM83, RMP84, RMP85

For PCB  
31,3 x 12,7 x 9 mm  
Two poles, 5 mm pinout  
12 A, 250 V AC

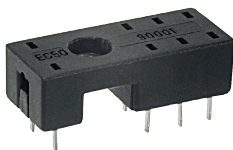

#### Pinout

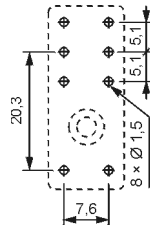

#### Dimensions

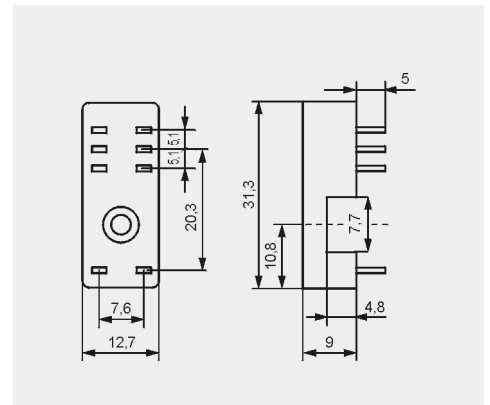

#### Accessories

### GD50

For RM84, RM85, RM85 inrush, RM85 105 °C sensitive, RM87L, RM87L sensitive, RM87P, RM87P sensitive, RM83, RMP84, RMP85

For PCB  
31,5 x 13 x 9 mm  
Two poles, 5 mm pinout  
8 A, 300 V AC



#### Pinout

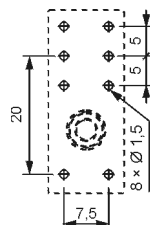

#### Dimensions

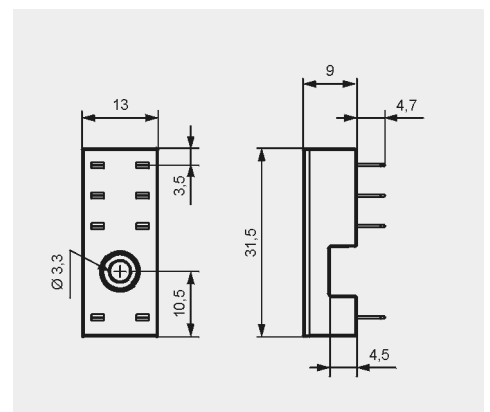

#### Accessories

## Signalling / protecting modules type M...

### For sockets type:

GZT80, GZM80, GZS80, GZMB80, GZT92, GZM92, GZS92, ES 32, GZT2, GZM2, GZMB2, GZT3, GZM3, GZT4, GZM4, GZMB4

Modules type M... are parallelly connected with relay coil.

Polarity P: -A1/+A2. Polarity N: +A1/-A2.

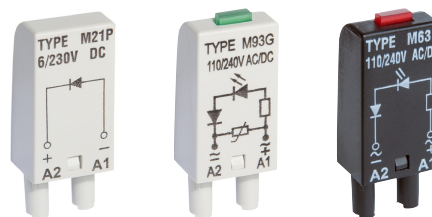

Modules type M...	Layout	Voltage	Type of module ① ②
<b>Module D (polarization P)</b> It limits overvoltage on DC coils.		6/230 V DC	M21P
<b>Module D (polarization N)</b> It limits overvoltage on DC coils.		6/230 V DC	M21N
<b>Module LD (polarization P)</b> It limits overvoltage on DC coils. Coil energizing indication.		6/24 V DC 24/60 V DC 110/230 V DC	M31R, M31G M32R, M32G M33R, M33G
<b>Module LD (polarization N)</b> It limits overvoltage on DC coils. Coil energizing indication.		6/24 V DC 24/60 V DC 110/230 V DC	M41R, M41G M42R, M42G M43R, M43G
<b>Module RC</b> It protects against EMC disturbance. It limits overvoltage.		6/24 V AC/DC 24/60 V AC/DC 110/240 V AC/DC	M51 M52 M53
<b>Module L</b> Coil energizing indication.		6/24 V AC/DC 24/60 V AC/DC 110/240 V AC/DC	M61R, M61G M62R, M62G M63R, M63G
<b>Module LV</b> It limits overvoltage on AC and DC coils. Coil energizing indication.		6/24 V AC/DC 24/60 V AC/DC 110/240 V AC/DC	M91R, M91G M92R, M92G M93R, M93G
<b>Module V</b> It limits overvoltage on AC coils. No indication.		6/24 V AC 110/130 V AC 220/240 V AC	M71 M72 M73
<b>Module R</b> It limits harmful voltage on AC coils induced in long lines which causes unwanted making of the relay.		110/240 V AC	M103

① M...R - LED red, M...G - LED green

② When ordering modules indicate their color: gray or black.

