



**RAYSTAR**

# 曜凌光電股份有限公司

住址: 42878 台中市大雅区科雅路 25 號 5F WEB: <http://www.Raystar-Optronics.com>  
5F., No.25, Keya Rd., Daya Dist., Taichung E-mail: [sales@raystar-optronics.com](mailto:sales@raystar-optronics.com)  
City 428, Taiwan Tel:886-4-2565-0761 Fax : 886-4-2565-0760

## RFH700U-AIW-LNN

---

### SPECIFICATION

CUSTOMER:

<b>APPROVED BY</b>	
<b>PCB VERSION</b>	
<b>DATE</b>	

FOR CUSTOMER USE ONLY

<b>SALES BY</b>	<b>APPROVED BY</b>	<b>CHECKED BY</b>	<b>PREPARED BY</b>

Release DATE:

TFT Display Inspection Specification: <https://www.raystar-optronics.com/download/products.htm>

Precaution in use of TFT module: <https://www.raystar-optronics.com/download/declaration.htm>

---

## Revision History

VERSION	DATE	REVISED PAGE NO.	Note
0	2015/07/20		First issue
A	2016/01/21		Modify Static electricity test
B	2016/08/11		Modify Vibration test
C	2016/10/08		Modify Summary

RAYSTAR OPTRONICS

# Contents

1. Module Classification Information
2. Summary
3. General Specification
4. Interface
5. Contour Drawing
6. Absolute Maximum Ratings
7. Electrical Characteristics
8. AC Characteristics
9. Optical Characteristics
10. Reliability
11. Other

## 1. Module Classification Information

R	F	H	70	0U	-	A	I	W	-	L	N	N
1	2	3	4	5	-	6	7	8	-	9	10	11

Item	Description	
1	R : Raystar Optronics Inc.	
2	Display Type : F→TFT Type, J→ Custom TFT	
3	Solution: A: 128x160    B:320x234    C:320x240    D:480x234    E:480x272 F:800x480    G:640x480    H:1024x600    I:320x480    J:240x320 K:1280x800    L:240x400    M:1024x768    N:128x128    O:480x800 P:640x320    Q:800x600    S:480x128    T:800x320	
4	Display Size : 7.0" TFT	
5	Version Code.	
6	Model Type: A : TFT LCD E : TFT+FR+CONTROL BOARD J : TFT+FR+A/D BOARD N : TFT+FR+A/D BOARD+CONTROL BOARD S : TFT+FR+POWER BOARD (DC TO DC) 1 : TFT+CONTROL BOARD	6 : TFT+FR H : TFT+D/V BOARD I : TFT+FR+D/V BOARD B : TFT+POWER BD
7	Polarizer Type, Temperature range, View direction	I→Transmissive, W. T, 6:00 ; C→Transmissive, N. T, 6:00 L→Transmissive, W.T,12:00 ; F→Transmissive, N.T,12:00 Y→Transmissive,W.T, IPS TFT ; A→Transmissive, N.T, IPS TFT Z→Transmissive, W.T, O-TFT R→Transmissive, Super W.T, O-TFT N→Transmissive, Super W.T, 6:00; Q→Transmissive, Super W.T, 12:00 V→Transmissive, Super W.T, VA TFT
8	Backlight	W : LED, White                                    H : LED, High Light White F : CCFL, White
9	Driver Method	D: Digital    A: Analog    L : LVDS    M:MIPI
10	Interface	N : without control board    A : 8Bit    B : 16Bit S:SPI Interface    R: RS232    U:USB    I: I2C
11	TS	N : Without TS    S : resistive touch panel C : capacitive touch panel capacitive touch panel (G-F-F) G : capacitive touch panel(G-G)

## 2.Summary

TFT 7.0”is a TN transmissive type color active matrix TFT liquid crystal display that use amorphous silicon TFT as switching devices. This module is a composed of a TFT\_LCD module, It is usually designed for industrial application and this module follows RoHs.

RAYSTAR OPTRONICS

---

### 3.General Specifications

- Size: 7.0 inch
- Dot Matrix: 1024 x RGBx600(TFT) dots
- Module dimension: 164.9(W) x 100(H) x 4.8(D) mm
- Active area: 154.2144 x 85.92 mm
- Dot pitch: 0.1506 x 0.1432 mm
- LCD type: TFT, Normally White, Transmissive
- View Direction: 12 o'clock
- Gray Scale Inversion Direction: 6 o'clock
- Backlight Type: LED, Normally White
- With /Without TP: Without TP
- Interface: LVDS
- Surface treatment: Hard Coating
- Surface: Glare

\*Color tone slight changed by temperature and driving voltage.

## 4.Interface

### 4.1. LCM PIN Definition

FPC Connector is used for the module electronics interface. The recommended model is FH12A-40S-0.5SH manufactured by Hirose.

Pin No.	Symbol	I/O	Function	Remark
1	VCOM	P	Common Voltage	
2	VDD	P	Power Voltage for digital circuit	
3	VDD	P	Power Voltage for digital circuit	
4	NC	---	No connection	
5	Reset	I	Global reset pin	
6	STBYB	I	Standby mode, Normally pulled high STBYB = "1", normal operation STBYB = "0", timing controller, source driver will turn off, all output are High-Z.	
7	GND	P	Ground	
8	RXIN0-	I	- LVDS differential data input	
9	RXIN0+	I	+ LVDS differential data input	
10	GND	P	Ground	
11	RXIN1-	I	- LVDS differential data input	
12	RXIN1+	I	+ LVDS differential data input	
13	GND	P	Ground	
14	RXIN2-	I	- LVDS differential data input	
15	RXIN2+	I	+ LVDS differential data input	
16	GND	P	Ground	
17	RXCLKIN-	I	- LVDS differential clock input	
18	RXCLKIN+	I	+ LVDS differential clock input	
19	GND	P	Ground	
20	RXIN3-	I	- LVDS differential data input	
21	RXIN3+	I	+ LVDS differential data input	
22	GND	P	Ground	
23	NC	---	No connection	

24	NC	---	No connection	
25	GND	P	Ground	
26	NC	---	No connection	
27	DIMO	O	Backlight CABC controller signal output	
28	SELB	I	6bit/8bit mode select	Note1
29	AVDD	P	Power for Analog Circuit	
30	GND	P	Ground	
31	LED-	P	LED Cathode	
32	LED-	P	LED Cathode	
33	L/R	I	Horizontal inversion	Note3
34	U/D	I	Vertical inversion	Note3
35	VGL	P	Gate OFF Voltage	
36	CABCEN1	I	CABC H/W enable	Note2
37	CABCEN0	I	CABC H/W enable	Note2
38	VGH	P	Gate ON Voltage	
39	LED+	P	LED Anode	
40	LED+	P	LED Anode	

I: input, O: output, P: Power

Note1: If LVDS input data is 6 bits ,SELB must be set to High;

If LVDS input data is 8 bits ,SELB must be set to Low.

Note2: When CABC\_EN="00", CABC OFF.

When CABC\_EN="01", user interface image.

When CABC\_EN="10", still picture.

When CABC\_EN="11", moving image.

When CABC off, don't connect DIMO, else connect it to backlight.

Note3: When L/R="0", set right to left scan direction.

When L/R="1", set left to right scan direction.

When U/D="0", set top to bottom scan direction.

When U/D="1", set bottom to top scan direction.



# 5. Contour Drawing

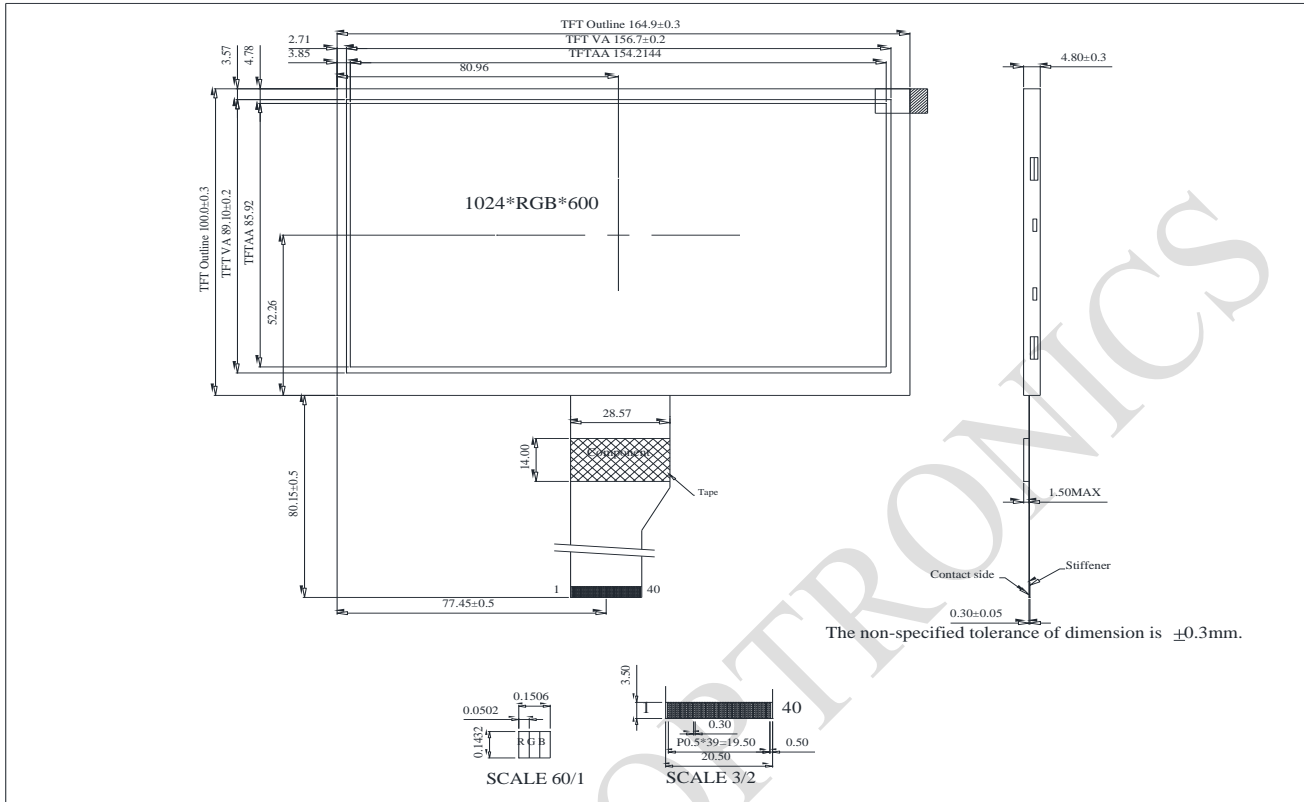

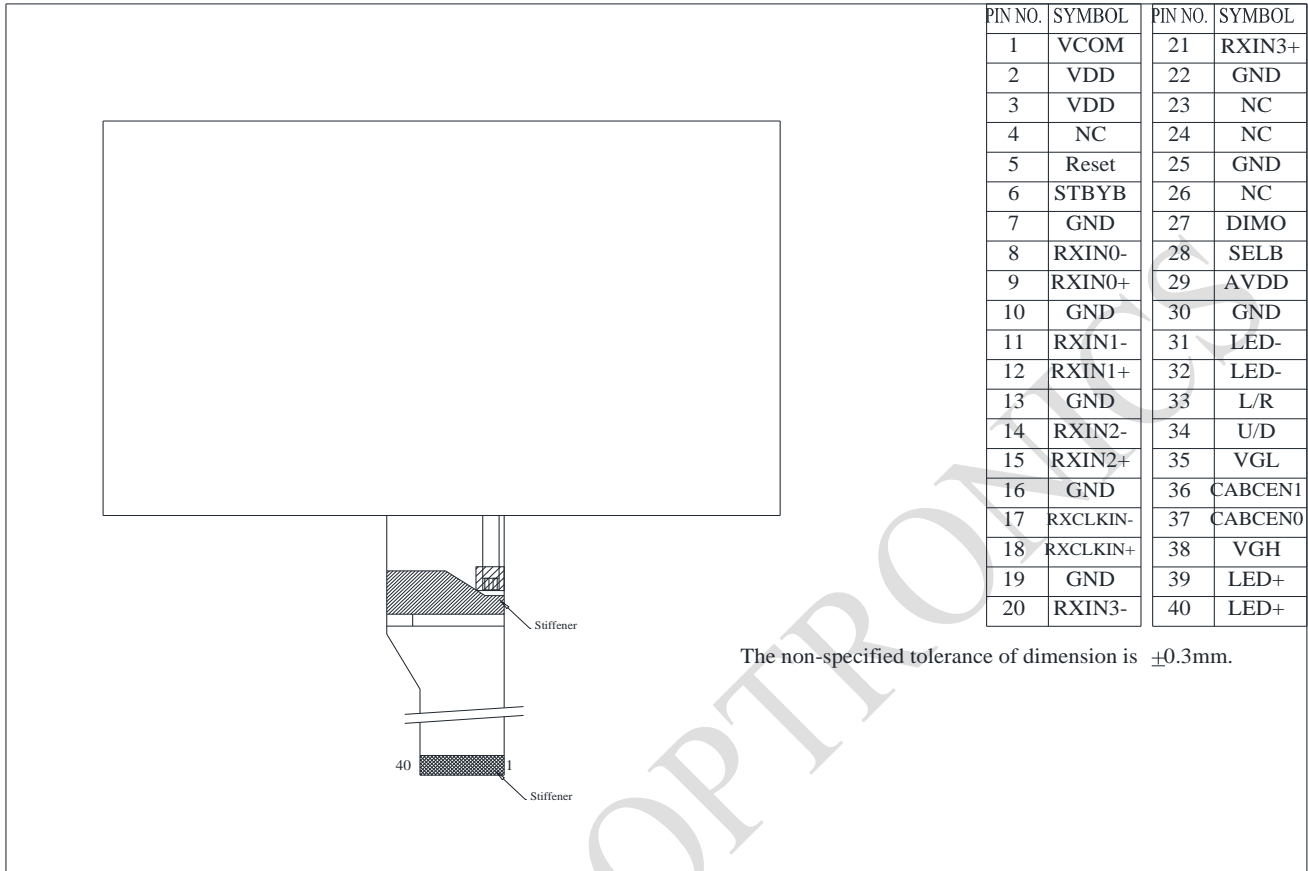

PIN NO.	SYMBOL	PIN NO.	SYMBOL
1	VCOM	21	RXIN3+
2	VDD	22	GND
3	VDD	23	NC
4	NC	24	NC
5	Reset	25	GND
6	STBYB	26	NC
7	GND	27	DIMO
8	RXIN0-	28	SELB
9	RXIN0+	29	AVDD
10	GND	30	GND
11	RXIN1-	31	LED-
12	RXIN1+	32	LED-
13	GND	33	L/R
14	RXIN2-	34	U/D
15	RXIN2+	35	VGL
16	GND	36	CABCEN1
17	RXCLKIN-	37	CABCEN0
18	RXCLKIN+	38	VGH
19	GND	39	LED+
20	RXIN3-	40	LED+

The non-specified tolerance of dimension is  $\pm 0.3\text{mm}$ .

RAYSTAR OPTRO

## 6. Absolute Maximum Ratings

Item	Symbol	Min	Typ	Max	Unit
Operating Temperature	TOP	-20	—	+70	°C
Storage Temperature	TST	-30	—	+80	°C

Note: Device is subject to be damaged permanently if stresses beyond those absolute maximum ratings listed above

- Temp.  $\leq 60^{\circ}\text{C}$ , 90% RH MAX. Temp.  $> 60^{\circ}\text{C}$ , Absolute humidity shall be less than 90% RH at  $60^{\circ}\text{C}$

RAYSTAR OPTRONICS

## 7. Electrical Characteristics

### 7.1. Typical Operation Conditions

( Note 1)

Item	Symbol	Values			Unit	Remark
		Min.	Typ.	Max.		
Power voltage	DVDD	3.0	3.3	3.6	V	Note 2
	AVDD	10.8	11	11.2	V	
	VGH	19.7	20	20.3	V	
	VGL	-6.5	-6.8	-7.1	V	
Input signal voltage	VCOM	3.3	3.8	4.3	V	Note 4
Input logic high voltage	VIH	0.7 DVDD	-	DVDD	V	Note 3
Input logic low voltage	VIL	0	-	0.3 DVDD	V	

Note 1: Be sure to apply DVDD and VGL to the LCD first, and then apply VGH.

Note 2: DVDD setting should match the signals output voltage (refer to Note 3) of customer's system board.

Note 3: LVDS, Reset.

Note 4: Typ. VCOM is only a reference value, it must be optimized according to each LCM.

Be sure to use VR;

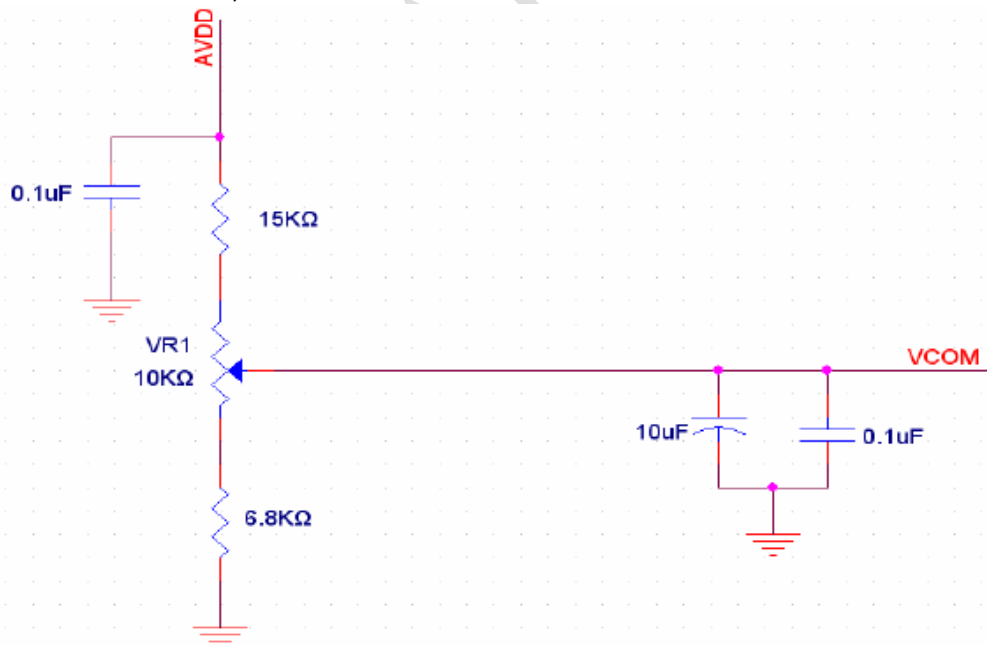

**7.2. Current Consumption**

Item	Symbol	Values			Unit	Remark
		Min.	Typ.	Max.		
Current for Driver	IGH	-	0.26	1	mA	VGH =20V
	IGL	-	0.26	1	mA	VGL = -6.8V
	IDVDD	-	35	60	mA	DVDD =3.3V
	IAVDD	-	20	30	mA	AVDD =11V

**7.3. Backlight Driving Conditions**

Item	Symbol	Values			Unit	Remark
		Min.	Typ.	Max.		
Voltage for LED backlight	VL	8.4	9.9	10.2	V	Note 1
Current for LED backlight	IL	--	265	--	mA	
LED life time	-	-	15,000	-	Hr	Note 2

Note 1: The LED Supply Voltage is defined by the number of LED at Ta=25°C and IL =265mA.

Note 2: The “LED life time” is defined as the module brightness decrease to 50% original brightness at Ta=25°C and IL =265mA. The LED lifetime could be decreased if operating IL is larger than 265mA.

# 8.Operation Specifications

## 8.1. Power Sequence

### a. Power on:

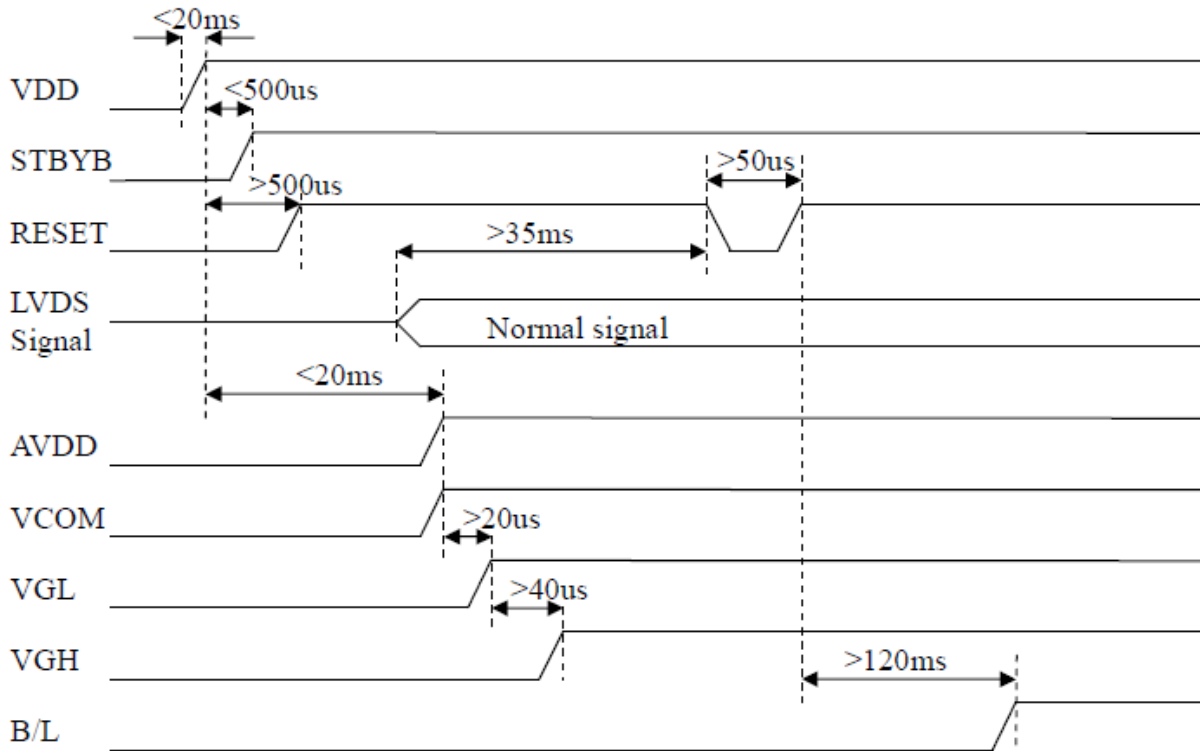

### b. Power off:

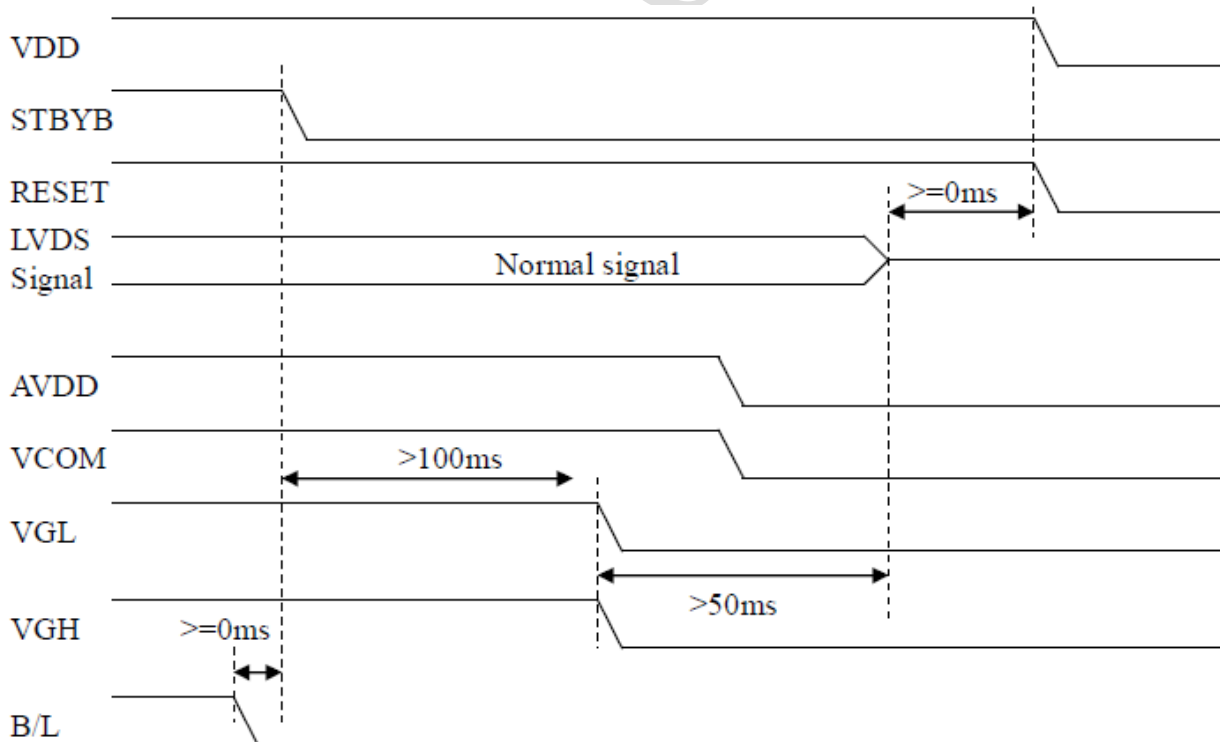

## 8.2. Timing Characteristics

### AC Electrical Characteristics

Parameter	Symbol	Values			Unit	Remark
		Min.	Typ.	Max.		
Clock frequency	R <sub>x</sub> FCLK	40.8	51.2	67.2	MHz	
Input data skew margin	T <sub>RSKM</sub>	500	-	-	ps	
Clock high time	TLVCH	-	4/(7* R <sub>x</sub> FCLK)	-	ns	
Clock low time	TLVCL	-	3/(7* R <sub>x</sub> FCLK)	-	ns	

### Input Clock and Data Timing Diagram

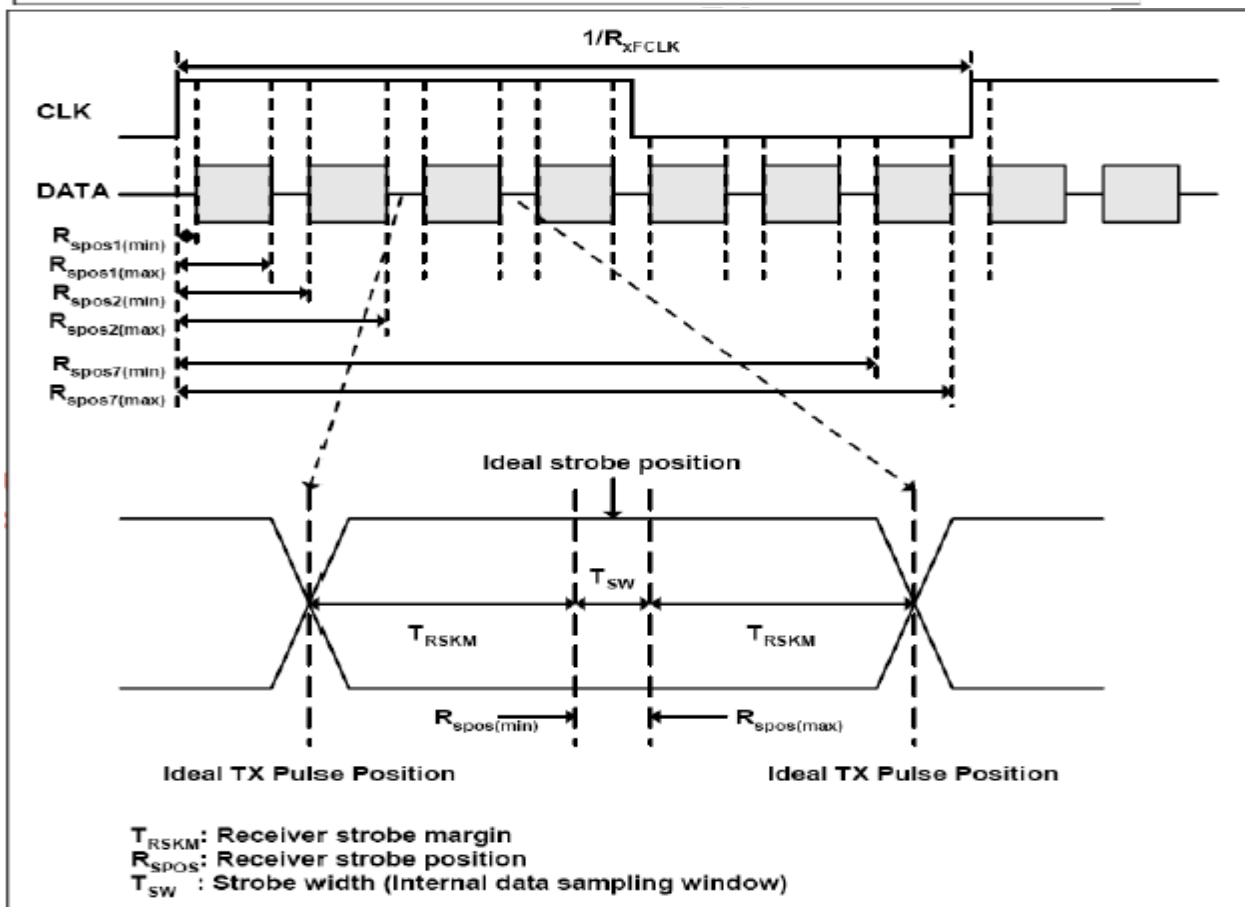
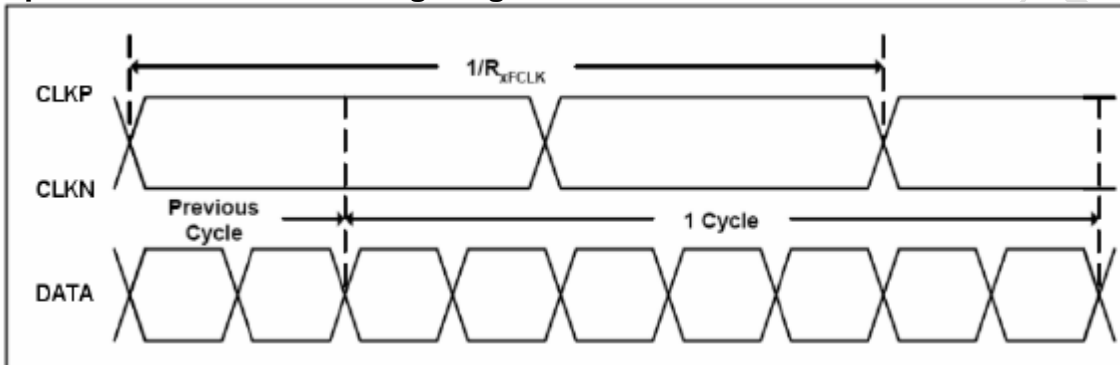

**DC Electrical Characteristics**

Parameter	Symbol	Value			Unit	Remark
		Min.	Typ.	Max.		
Differential input high Threshold voltage	$R_{xVTH}$	-	-	+0.1	V	$R_{xVCM}=1.2$ V
Differential input low Threshold voltage	$R_{xVTL}$	-0.1	-	-	V	
Input voltage range (singled-end)	$R_{xVIN}$	0	-	2.4	V	
Differential input common mode voltage	$R_{xVCM}$	$ VID /2$	-	$2.4- VID /2$	V	
Differential voltage	$ VID $	0.2	-	0.6	V	
Differential input leakage current	$R_{VxIz}$	-10	-	+10	$\mu A$	

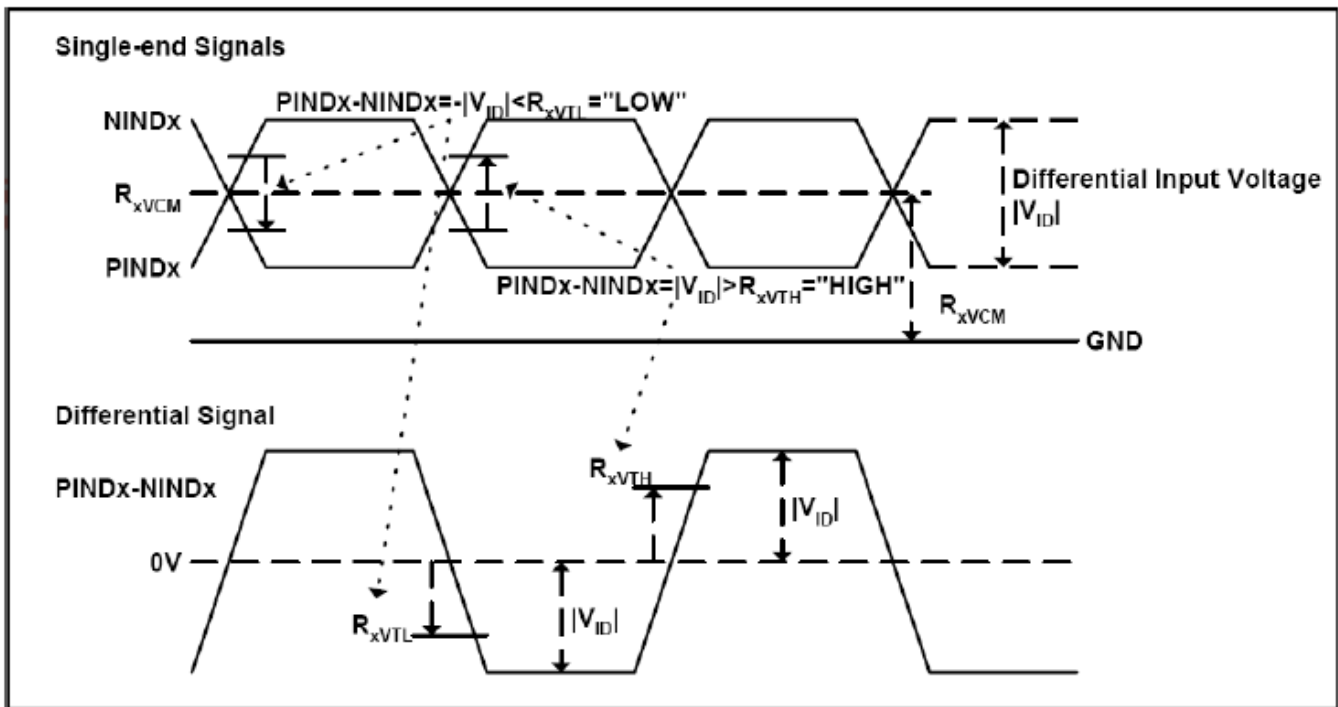



**Timing**

Item	Symbol	Values			Unit	Remark
		Min.	Typ.	Max.		
Clock Frequency	fclk	40.8	51.2	67.2	MHz	Frame rate =60Hz
Horizontal display area	thd	1024			DCLK	
HS period time	th	1114	1344	1400	DCLK	
HS Blanking	thb	90	320	376	DCLK	
Vertical display area	tvd	600			H	
VS period time	tv	610	635	800	H	
VS Blanking	thb	10	35	200	H	

RAYSTAR OPTRONICS

**Data Input Format**  
**6bit LVDS input**

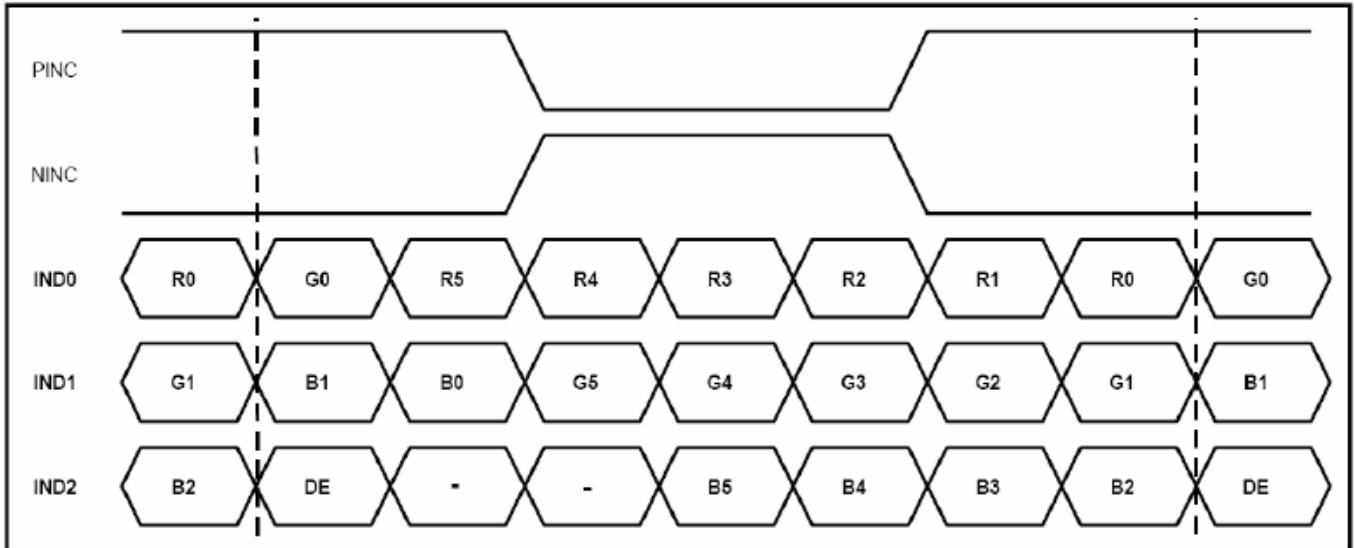

**8bit LVDS input**

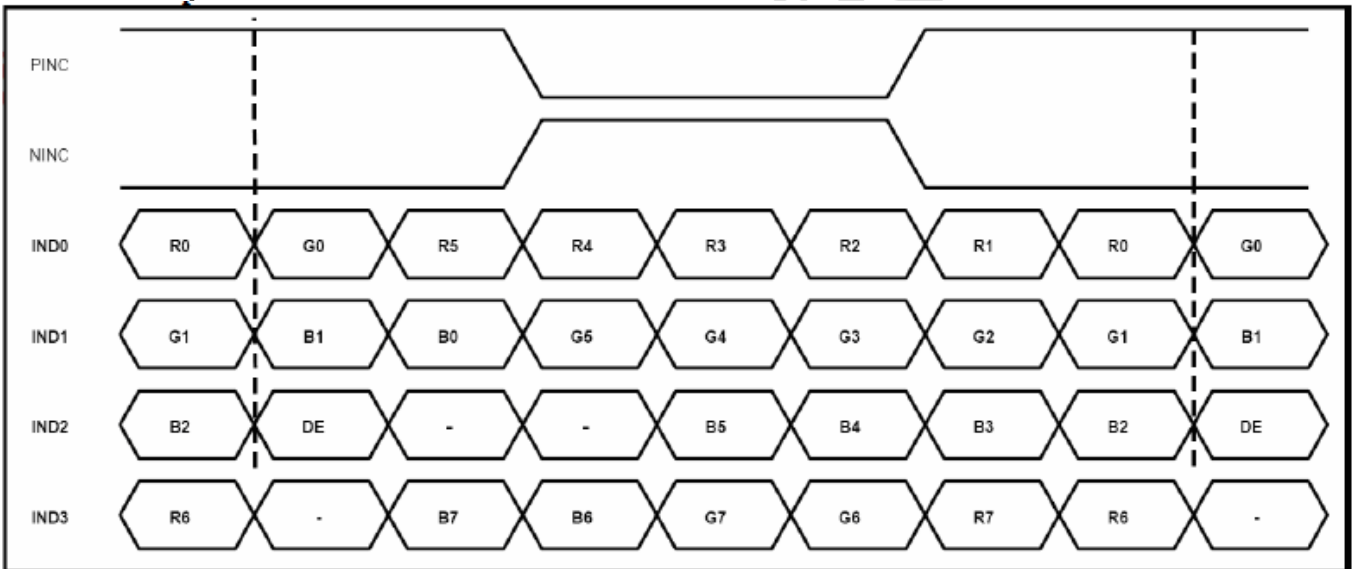

Note: Support DE timing mode only, SYNC mode not supported.

## 9. Optical Characteristics

Item	Symbol	Condition.	Min	Typ.	Max.	Unit	Remark	
Response time	$T_r$	$\theta=0^\circ$ 、 $\Phi=0^\circ$	-	10	20	.ms	Note 3	
	$T_f$		-	15	30	.ms		
Contrast ratio	CR	At optimized viewing angle	500	800	-	-	Note 4	
Color Chromaticity	White	$W_x$	$\theta=0^\circ$ 、 $\Phi=0^\circ$	0.26	0.31	0.36	-	Note 2,5,6
		$W_y$		0.28	0.33	0.38	-	
Viewing angle (Gray Scale Inversion Direction)	Hor.	$\Theta_R$	CR $\cong$ 10	65	75	-	Deg.	Note 1
		$\Theta_L$		65	75	-		
	Ver.	$\Phi_T$		60	70	-		
		$\Phi_B$		65	75	-		
Brightness	-	-	400	500	-	cd/m <sup>2</sup>	Center of display	

$T_a=25\pm 2^\circ\text{C}$ ,

Note 1: Definition of viewing angle range

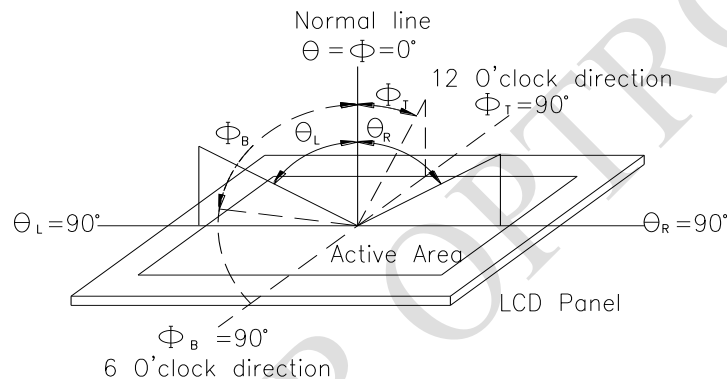

Fig. 9.1. Definition of viewing angle

Note 2: Test equipment setup:

After stabilizing and leaving the panel alone at a driven temperature for 10 minutes, the measurement should be executed. Measurement should be executed in a stable, windless, and dark room. Optical specifications are measured by Topcon BM-7 or BM-5 luminance meter 1.0° field of view at a distance of 50cm and normal direction.

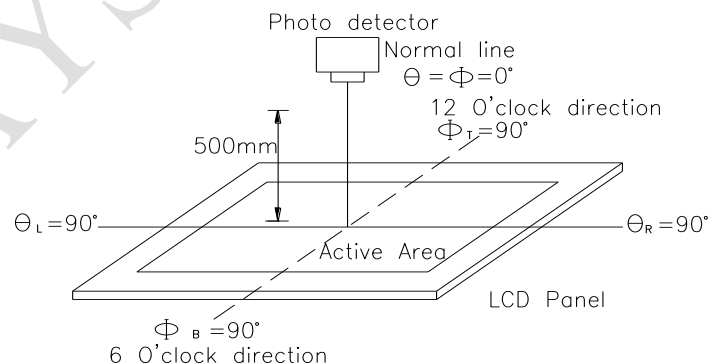
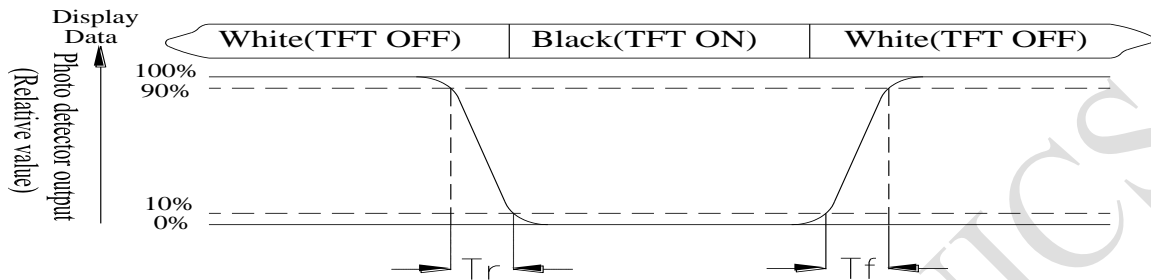

Fig. 9.2. Optical measurement system setup

Note 3: Definition of Response time:

The response time is defined as the LCD optical switching time interval between “White” state and “Black” state. Rise time,  $T_r$ , is the time between photo detector output intensity changed from 90% to 10%. And fall time,  $T_f$ , is the time between photo detector output intensity changed from 10% to 90%



Note 4: Definition of contrast ratio:

The contrast ratio is defined as the following expression.

$$\text{Contrast ratio (CR)} = \frac{\text{Luminance measured when LCD on the "White" state}}{\text{Luminance measured when LCD on the "Black" state}}$$

Note 5: White  $V_i = V_{i50} \pm 1.5V$

Black  $V_i = V_{i50} \pm 2.0V$

“±” means that the analog input signal swings in phase with VCOM signal.

“±” means that the analog input signal swings out of phase with VCOM signal.

The 100% transmission is defined as the transmission of LCD panel when all the input terminals of module are electrically opened.

Note 6: Definition of color chromaticity (CIE 1931)

Color coordinates measured at the center point of LCD

Note 7: Measured at the center area of the panel when all the input terminals of LCD panel are electrically opened.

# 10. Reliability

Content of Reliability Test (Wide temperature, -20°C~70°C)

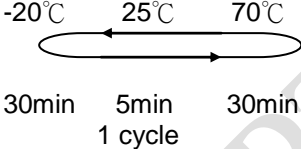
Environmental Test			
Test Item	Content of Test	Test Condition	Note
High Temperature storage	Endurance test applying the high storage temperature for a long time.	80°C 200hrs	2
Low Temperature storage	Endurance test applying the low storage temperature for a long time.	-30°C 200hrs	1,2
High Temperature Operation	Endurance test applying the electric stress (Voltage & Current) and the thermal stress to the element for a long time.	70°C 200hrs	—
Low Temperature Operation	Endurance test applying the electric stress under low temperature for a long time.	-20°C 200hrs	1
High Temperature/ Humidity Operation	The module should be allowed to stand at 60°C,90%RH max	60°C,90%RH 96hrs	1,2
Thermal shock resistance	The sample should be allowed stand the following 10 cycles of operation  <div style="text-align: center;">  <p>-20°C      25°C      70°C</p> <p>30min    5min    30min</p> <p>1 cycle</p> </div>	-20°C/70°C 10 cycles	—
Vibration test	Endurance test applying the vibration during transportation and using.	Total fixed amplitude : 3 1.5mm Vibration Frequency : 10~55Hz One cycle 60 seconds to 3 directions of X,Y,Z for Each 15 minutes	3
Static electricity test	Endurance test applying the electric stress to the terminal.	VS=±600V(contact) ,±800v(air), RS=330Ω CS=150pF 10 times	—

Note1: No dew condensation to be observed.

Note2: The function test shall be conducted after 4 hours storage at the normal Temperature and humidity after remove from the test chamber.

Note3: The packing have to including into the vibration testing.

**LCM Sample Estimate Feedback Sheet**

**Module Number :** \_\_\_\_\_

**1 、 Panel Specification :**

1. Panel Type :	<input type="checkbox"/> Pass	<input type="checkbox"/> NG , _____
2. View Direction :	<input type="checkbox"/> Pass	<input type="checkbox"/> NG , _____
3. Numbers of Dots :	<input type="checkbox"/> Pass	<input type="checkbox"/> NG , _____
4. View Area :	<input type="checkbox"/> Pass	<input type="checkbox"/> NG , _____
5. Active Area :	<input type="checkbox"/> Pass	<input type="checkbox"/> NG , _____
6. Operating Temperature :	<input type="checkbox"/> Pass	<input type="checkbox"/> NG , _____
7. Storage Temperature :	<input type="checkbox"/> Pass	<input type="checkbox"/> NG , _____
8. Others :	_____	

**2 、 Mechanical Specification :**

1. PCB Size :	<input type="checkbox"/> Pass	<input type="checkbox"/> NG , _____
2. Frame Size :	<input type="checkbox"/> Pass	<input type="checkbox"/> NG , _____
3. Material of Frame :	<input type="checkbox"/> Pass	<input type="checkbox"/> NG , _____
4. Connector Position :	<input type="checkbox"/> Pass	<input type="checkbox"/> NG , _____
5. Fix Hole Position :	<input type="checkbox"/> Pass	<input type="checkbox"/> NG , _____
6. Backlight Position :	<input type="checkbox"/> Pass	<input type="checkbox"/> NG , _____
7. Thickness of PCB :	<input type="checkbox"/> Pass	<input type="checkbox"/> NG , _____
8. Height of Frame to PCB :	<input type="checkbox"/> Pass	<input type="checkbox"/> NG , _____
9. Height of Module :	<input type="checkbox"/> Pass	<input type="checkbox"/> NG , _____
10. Others :	<input type="checkbox"/> Pass	<input type="checkbox"/> NG , _____

**3 、 Relative Hole Size :**

1. Pitch of Connector :	<input type="checkbox"/> Pass	<input type="checkbox"/> NG , _____
2. Hole size of Connector :	<input type="checkbox"/> Pass	<input type="checkbox"/> NG , _____
3. Mounting Hole size :	<input type="checkbox"/> Pass	<input type="checkbox"/> NG , _____
4. Mounting Hole Type :	<input type="checkbox"/> Pass	<input type="checkbox"/> NG , _____
5. Others :	<input type="checkbox"/> Pass	<input type="checkbox"/> NG , _____

**4 、 Backlight Specification :**

1. B/L Type :	<input type="checkbox"/> Pass	<input type="checkbox"/> NG , _____
2. B/L Color :	<input type="checkbox"/> Pass	<input type="checkbox"/> NG , _____
3. B/L Driving Voltage (Reference for LED Type) :	<input type="checkbox"/> Pass	<input type="checkbox"/> NG , _____
4. B/L Driving Current :	<input type="checkbox"/> Pass	<input type="checkbox"/> NG , _____
5. Brightness of B/L :	<input type="checkbox"/> Pass	<input type="checkbox"/> NG , _____
6. B/L Solder Method :	<input type="checkbox"/> Pass	<input type="checkbox"/> NG , _____
7. Others :	<input type="checkbox"/> Pass	<input type="checkbox"/> NG , _____

>> **Go to page 2** <<

**Module Number :** \_\_\_\_\_

**5 · Electronic Characteristics of Module :**

1.Input Voltage :	<input type="checkbox"/> Pass	<input type="checkbox"/> NG , _____
2.Supply Current :	<input type="checkbox"/> Pass	<input type="checkbox"/> NG , _____
3.Driving Voltage for LCD :	<input type="checkbox"/> Pass	<input type="checkbox"/> NG , _____
4.Contrast for LCD :	<input type="checkbox"/> Pass	<input type="checkbox"/> NG , _____
5.B/L Driving Method :	<input type="checkbox"/> Pass	<input type="checkbox"/> NG , _____
6.Negative Voltage Output :	<input type="checkbox"/> Pass	<input type="checkbox"/> NG , _____
7.Interface Function :	<input type="checkbox"/> Pass	<input type="checkbox"/> NG , _____
8.LCD Uniformity :	<input type="checkbox"/> Pass	<input type="checkbox"/> NG , _____
9.ESD test :	<input type="checkbox"/> Pass	<input type="checkbox"/> NG , _____
10.Others :	<input type="checkbox"/> Pass	<input type="checkbox"/> NG , _____

**6 · Summary :**
**Sales signature :** \_\_\_\_\_

**Customer Signature :** \_\_\_\_\_

**Date :**    /    /    \_\_\_\_\_