

APPROVAL SHEET

WLPN242410 Series Shielded SMD Power Inductors

*Contents in this sheet are subject to change without prior notice.

Features

1. Close magnetic loop with magnetic resin shielded.
2. Low profile, High inductance.

Applications

1. General propose power inductor in DC power system.
2. Inductor in DC/DC converter.
3. Low profile for portable and wearable device.
4. LC filter in Audio D class Amplifier.

Shape and Dimension

Unit: mm

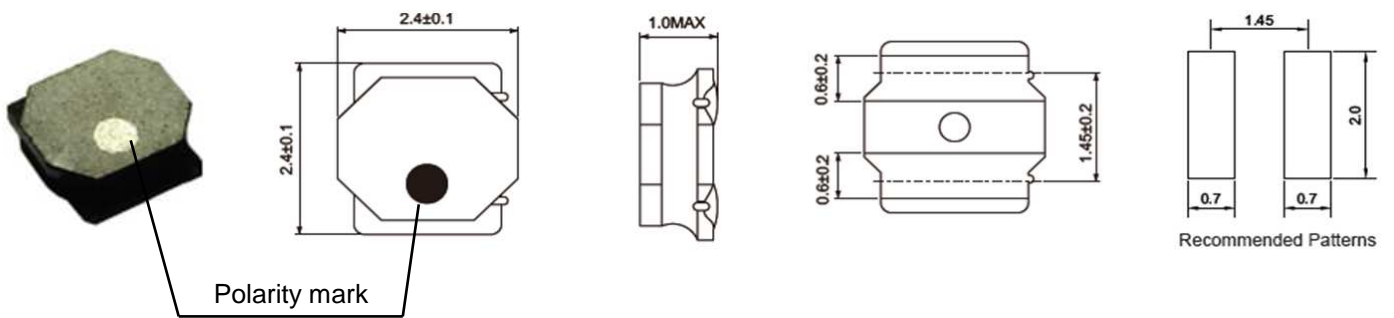

Ordering Information

WL	PN	2424	10	N	R68	P	B
Product Code WL: Inductor	Series Shielded SMD Power Inductors	Dimensions 2.4 * 2.4 mm	Thickness 1.0 mm	Tolerance M: ± 20% N: ± 30%	Value R68 = 0.68uH 2R2 = 2.2uH 100 = 10uH	Packing Code P=7" Reeled (Embossed Tape)	B:STD

Electrical Characteristics

WLPN242410 Series	L (μ H)	Inductance Tolerance	Test Freq (KHz)	DCR ($\Omega \pm 20\%$)	SRF (MHz)Min	Rated Current (mA) Max	
						Saturation Current Idc1	Temperature Rise Current Idc2
WLPN242410NR68PB	0.68	$\pm 30\%$	100	0.06	120	2200	1570
WLPN242410N1R0PB	1.0	$\pm 30\%$	100	0.07	106	1800	1410
WLPN242410M1R5PB	1.5	$\pm 20\%$	100	0.11	94	1550	1160
WLPN242410M2R2PB	2.2	$\pm 20\%$	100	0.15	77	1290	970
WLPN242410M3R3PB	3.3	$\pm 20\%$	100	0.22	56	1000	770
WLPN242410M4R7PB	4.7	$\pm 20\%$	100	0.29	50	880	670
WLPN242410M6R8PB	6.8	$\pm 20\%$	100	0.41	43	750	570
WLPN242410M100PB	10	$\pm 20\%$	100	0.69	32	550	450
WLPN242410M150PB	15	$\pm 20\%$	100	1.02	27	470	370

1. Test Frequency: 100KHz.
2. Test Equipment:
Inductance: Chroma3302+1320+16502 or equivalent.
DCR: Chroma16502 or equivalent.
SRF: HP4291B or equivalent.
3. Saturation Current Idc1: The value of current causes a 30% inductance reduction from initial value.
4. Temperature rise current Idc2: The value of current causes a 40°C temperature rise.
5. Rated Current: Either Idc1 or Idc2 whichever is smaller.
6. Operating Temperature Range:-25°C to +120°C (Including self-temperature rise).
7. Storage Temp. Range : -40°C to +85°C.
8. MSL : Level 1.

Structural Drawing

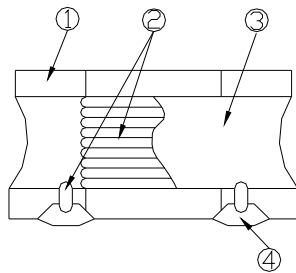

- ① Ferrite core : Ni-Zn ferrite.
- ② Winding wire : Polyurethane-copper wire.
- ③ Over-coating resin : Epoxy resin, containing ferrite powder.
- ④ Electrode : External electrode (substrate) Cu.
External electrode (top surface solder coating) Sn-Ag-Cu.

Characteristic Curve

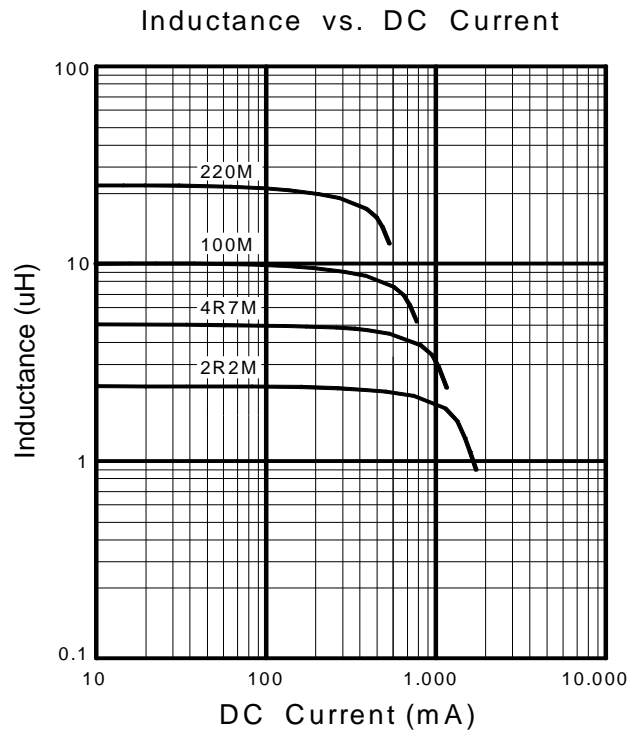

Core Chipping:

The appearance standard of the chipping size in top side, of bottom side ferrite core is following dimension.

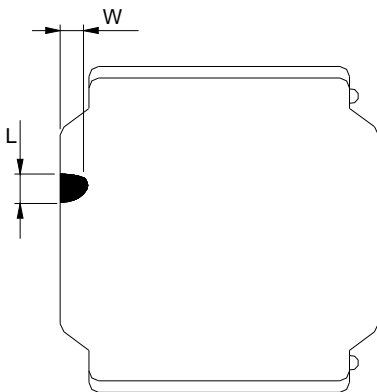

L	W
0.5mmMax.	0.5mmMax.

Exposed wire tolerance limit of coating resin part on product side
Size of exposed wire occurring to coating resin is specified below.

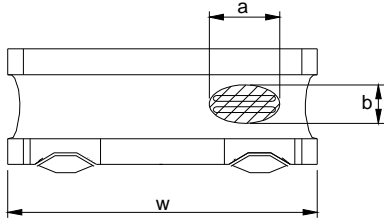

- ① Width direction (dimension a): Acceptable when $a \leq w/2$
 Nonconforming when $a > w/2$
- ② Length direction (dimension b): Dimension b is not specified.
- ③ When total area of exposed wire occurring to each sides is not greater than 50% of coating resin area, that is acceptable.

Reflow Profile Chart (Reference):

Typical RoHS Reflow Profile

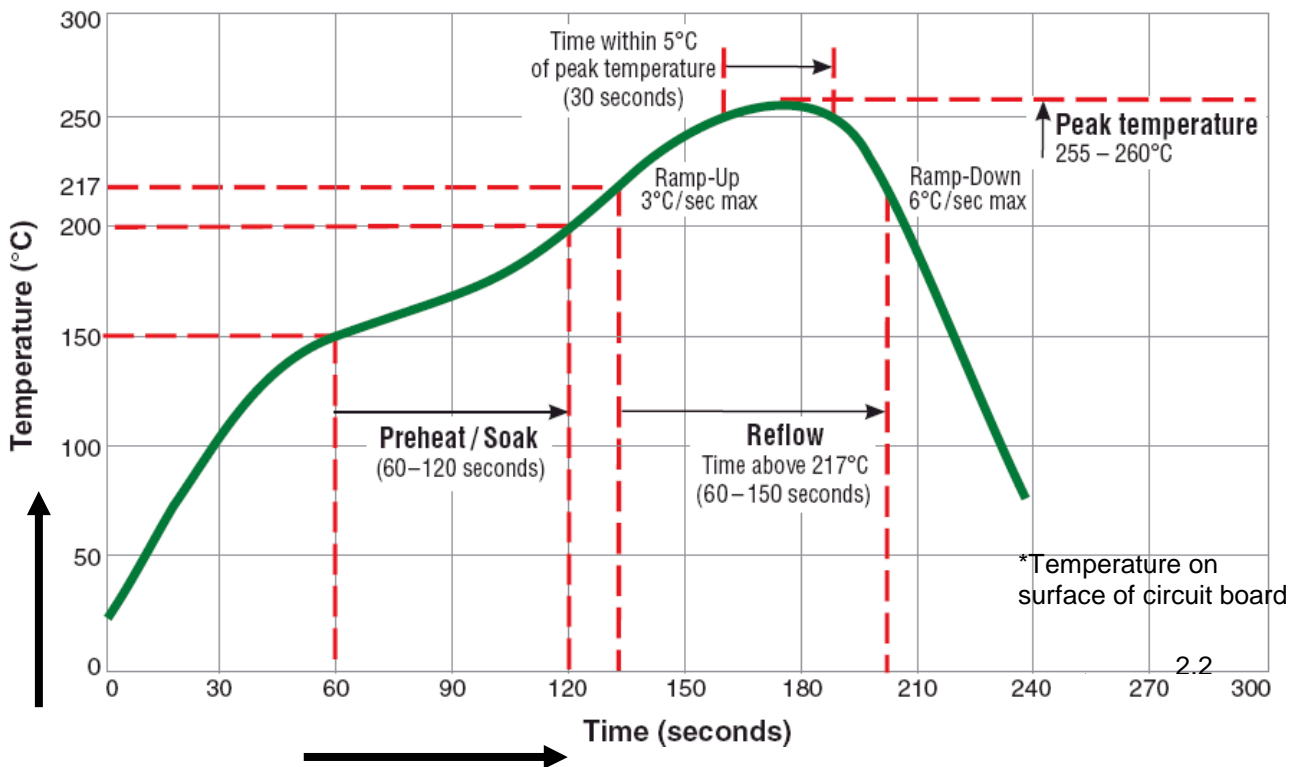

(Table 1)

The products may be exposed to reflow soldering process of above profile up to two times.

Mechanical Performance /Environmental Test Performance Specifications: (WLPN242410 series)

No.	Item	Test condition	Requirements								
1	Resistance to Deflection.	No damage.	<p>The test samples shall be soldered to the test board by the reflow soldering conditions show in Table 1. As illustrated below, apply force in the direction of the Arrow indicating until deflection of the test board Reaches to 2 mm.</p> <p>Test board size :100x40x10 Test board material I: glass epoxy-resin Solder cream thickness:0.1 Unit: mm</p>								
2	Adhesion of Terminal Electrode.	Shall not come off PC board.	<p>The test samples shall be soldered to the test board by the reflow soldering conditions shown in Table 1.</p> <p>Applied force: 10 N to X and Y directions Duration: 5 s. Solder cream thickness:0.1 mm. (Refer to recommended Land Pattern Dimensions Defined in "Precaution")</p>								
3	Body strength.	No damage.	<p>Applied force :20 N. Duration :10 s.</p>								
4	Resistance to Vibration.	△L/L:within±10% No abnormality observed In appearance.	<p>The test samples shall be soldered to the test board by the reflow soldering conditions shown in Table 1.Then it shall be submitted to below test conditions.</p> <table border="1"> <tr> <td>Frequency range</td> <td>10Hz~55Hz</td> </tr> <tr> <td>Total Amplitude</td> <td>1.5mm(May not exceed acceleration 196 m/S²)</td> </tr> <tr> <td>Sweeping Method</td> <td>10Hz to 55Hz to 10 Hz for 1 min.</td> </tr> <tr> <td>Time</td> <td>For 2 hours on each X, Y, and Z axis.</td> </tr> </table>	Frequency range	10Hz~55Hz	Total Amplitude	1.5mm(May not exceed acceleration 196 m/S ²)	Sweeping Method	10Hz to 55Hz to 10 Hz for 1 min.	Time	For 2 hours on each X, Y, and Z axis.
Frequency range	10Hz~55Hz										
Total Amplitude	1.5mm(May not exceed acceleration 196 m/S ²)										
Sweeping Method	10Hz to 55Hz to 10 Hz for 1 min.										
Time	For 2 hours on each X, Y, and Z axis.										
5	Resistance to Soldering heat (Reflow).	△L/L:within±10% No abnormality observed In appearance.	<p>The test sample shall be exposed to reflow oven at 230±5 deg C for 40 seconds, with peak temperature at 260±5 deg C for 5 seconds, 2 times.</p> <p>Test board thickness: 1.0 mm. Test board material: glass epoxy-resin.</p>								

6	Solder ability.	At least 90% of surface of terminal electrode is covered by new solder.	The test samples shall be dipped in flux, and then Immersed in molten solder as shown in below table. Flux: Methanol solution containing rosin 25%.												
			<table border="1"> <tr> <td>Solder Temperature</td> <td>245±deg C</td> </tr> <tr> <td>Time</td> <td>5±1.0 S.</td> </tr> <tr> <td>Immersing Speed</td> <td>25 mm/s</td> </tr> </table>	Solder Temperature	245±deg C	Time	5±1.0 S.	Immersing Speed	25 mm/s						
Solder Temperature	245±deg C														
Time	5±1.0 S.														
Immersing Speed	25 mm/s														
7	Temperature Characteristics.	△L/L:within±20% No abnormality observed in appearance.	Measurement of inductance shall be taken at temperature range within -25 deg C to +85 deg C. With reference to inductance value at +20 deg C, change rate shall be calculated.												
8	Thermal shock.	△L/L:within±10% No abnormality observed in appearance.	The test samples shall be soldered to test board by the reflow soldering conditions shown in Table 1. The test samples shall be placed at specified shown in below table in sequence. The temperature cycle shall be repeated 100 cycles.												
			<p>Conditions of steps for 1 cycle</p> <table border="1"> <thead> <tr> <th>Step</th> <th>Temperature</th> <th>Time(min)</th> </tr> </thead> <tbody> <tr> <td>1</td> <td>-40±3 deg C</td> <td>30±3</td> </tr> <tr> <td>2</td> <td>Room Temp</td> <td>3 maximum</td> </tr> <tr> <td>3</td> <td>85±2 deg C</td> <td>30±3</td> </tr> <tr> <td>4</td> <td>Room Temp</td> <td>3 maximum</td> </tr> </tbody> </table>	Step	Temperature	Time(min)	1	-40±3 deg C	30±3	2	Room Temp	3 maximum	3	85±2 deg C	30±3
Step	Temperature	Time(min)													
1	-40±3 deg C	30±3													
2	Room Temp	3 maximum													
3	85±2 deg C	30±3													
4	Room Temp	3 maximum													
9	Low Temperature life Test.	△L/L:within±10% No abnormality observed in appearance.	The test samples shall be soldered to the test board by the reflow soldering conditions shown in Table 1. After that, the test samples shall be placed at test conditions as shown in below table.												
			<table border="1"> <tr> <td>Temperature</td> <td>-40±2 deg C</td> </tr> <tr> <td>Time</td> <td>500 +24/-0 h</td> </tr> </table>	Temperature	-40±2 deg C	Time	500 +24/-0 h								
Temperature	-40±2 deg C														
Time	500 +24/-0 h														
10	Loading at high temperature life test.	△L/L:within±10% No abnormality observed in appearance.	The test samples shall be soldered to the test board by the reflow soldering conditions shown in Table 1. The test samples shall be placed in thermostatic oven set at specified temperature and applied the rated current continuously as shown in below table.												
			<table border="1"> <tr> <td>Temperature</td> <td>85±2 deg C</td> </tr> <tr> <td>Applied current</td> <td>Rated current (Refer to Page 2)</td> </tr> <tr> <td>Time</td> <td>500+24/-0 h</td> </tr> </table>	Temperature	85±2 deg C	Applied current	Rated current (Refer to Page 2)	Time	500+24/-0 h						
Temperature	85±2 deg C														
Applied current	Rated current (Refer to Page 2)														
Time	500+24/-0 h														
11	Damp heat life test.	△L/L:within±10% No abnormality observed in appearance.	The test samples shall be soldered to the test board by the reflow soldering conditions shown in Table 1. The test samples shall be placed in thermostatic oven set at specified temperature and humidity as shown in below table.												
			<table border="1"> <tr> <td>Temperature</td> <td>60±2 deg C</td> </tr> <tr> <td>Humidity</td> <td>90~95%RH</td> </tr> <tr> <td>Time</td> <td>500+24/-0 h</td> </tr> </table>	Temperature	60±2 deg C	Humidity	90~95%RH	Time	500+24/-0 h						
Temperature	60±2 deg C														
Humidity	90~95%RH														
Time	500+24/-0 h														
12	Loading under Damp heat life test.	△L/L:within±10% No abnormality observed in appearance.	The test samples shall be soldered to the test board by the reflow soldering conditions shown in Table 1. The test samples shall be placed in thermostatic oven set at specified temperature and humidity and applied the rated current continuously as shown in below table.												
			<table border="1"> <tr> <td>Temperature</td> <td>60±2 deg C</td> </tr> <tr> <td>Humidity</td> <td>90~95%RH</td> </tr> <tr> <td>Applied current</td> <td>Rated current (Refer to Page 2)</td> </tr> <tr> <td>Time</td> <td>500+24/-0 h</td> </tr> </table>	Temperature	60±2 deg C	Humidity	90~95%RH	Applied current	Rated current (Refer to Page 2)	Time	500+24/-0 h				
Temperature	60±2 deg C														
Humidity	90~95%RH														
Applied current	Rated current (Refer to Page 2)														
Time	500+24/-0 h														

Tape & Reel Packaging Dimensions:

Dimensions Unit: mm

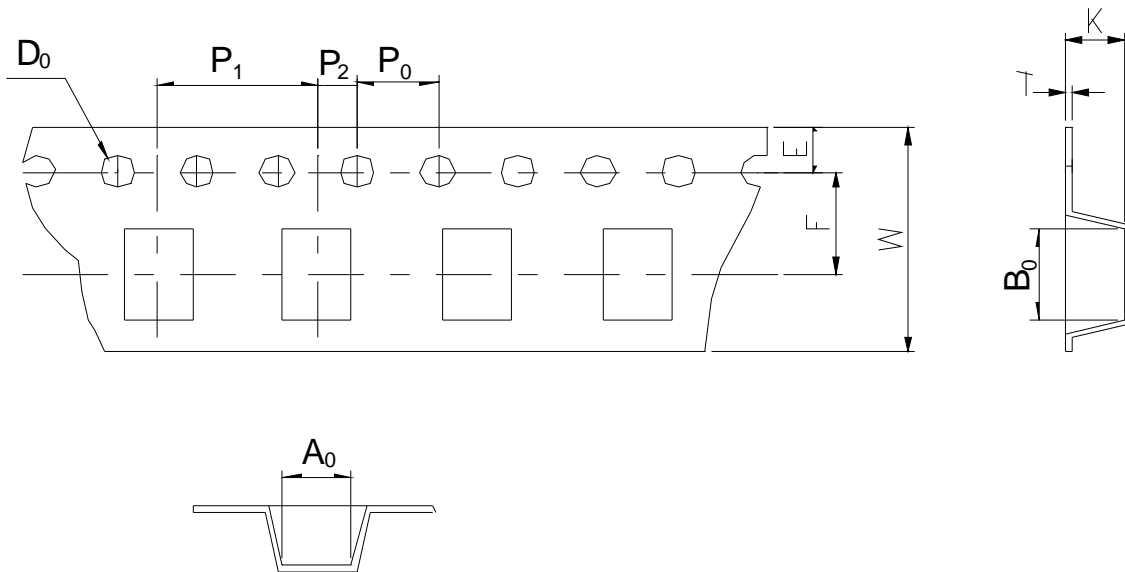

A ₀	B ₀	W	F	E	P ₁	P ₂	P ₀	D ₀	T	K
2.6 ±0.1	2.6 ±0.1	8.0 ±0.2	3.5 ±0.1	1.75 ±0.1	4.0 ±0.1	2.0 ±0.05	4.0± 0.1	Φ1.5 +0.1 -0	0.25 ±0.05	1.3 ±0.1

Direction of rolling

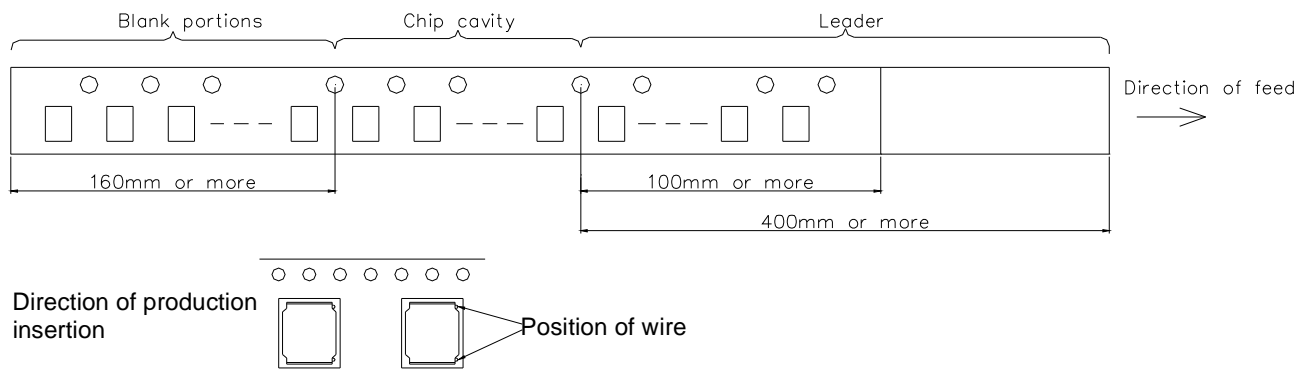

Reel

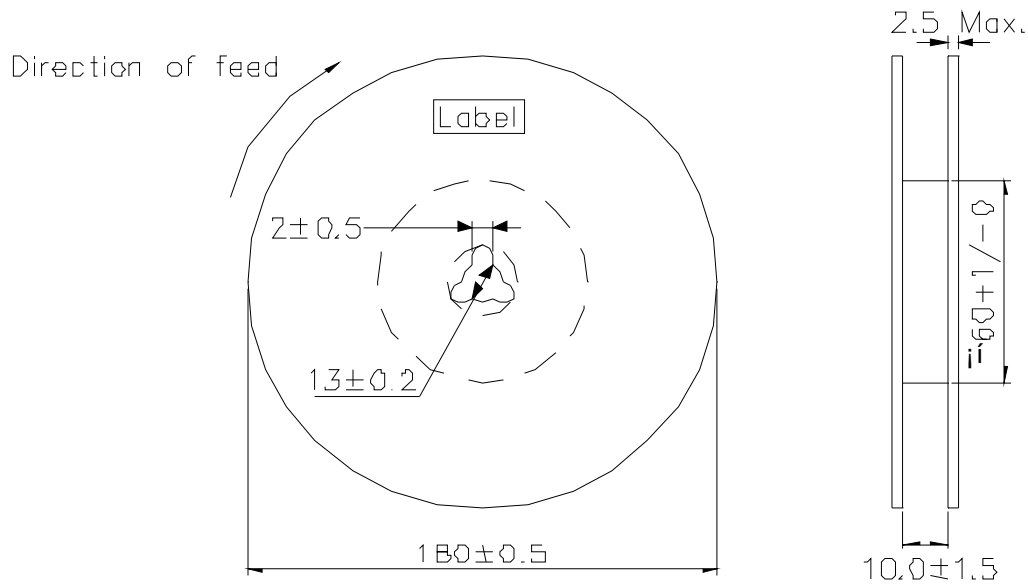

Label position: on the opposite side of sprocket holes side of reel

Top tape strength

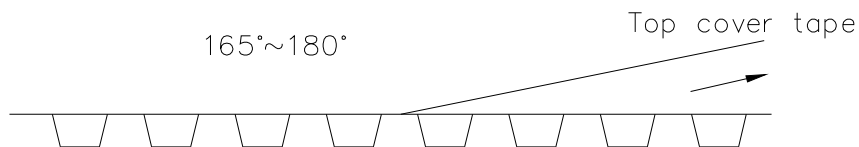

Peel-off strength: 0.1N~0.7N

Peel-off angle: $165^\circ \sim 180^\circ$

Peel-off speed: 300mm/mm

Quantity per reel : 2.5K pcs