

300-mA, Low- I_Q , Low-Dropout Regulator

FEATURES

- **Very Low Dropout:**
 - 37 mV at $I_{OUT} = 50$ mA, $V_{OUT} = 2.8$ V
 - 75 mV at $I_{OUT} = 100$ mA, $V_{OUT} = 2.8$ V
 - 220mV at $I_{OUT} = 300$ mA, $V_{OUT} = 2.8$ V
- **2% Accuracy**
- **Low I_Q : 35 μ A**
- **Fixed-Output Voltage Combinations Possible from 1.2 V to 4.8 V**
- **High PSRR: 68 dB at 1 kHz**
- **Stable with Effective Capacitance of 0.1 μ F⁽¹⁾**
- **Thermal Shutdown and Overcurrent Protection**
- **Packages: SOT23-5 and 1,5mm \times 1,5mm SON-6**

⁽¹⁾ See the [Input and Output Capacitor Requirements](#) in the Application Information section.

APPLICATIONS

- **Wireless Handsets**
- **Smart Phones, PDAs**
- **MP3 Players**
- **ZigBee[®] Networks**
- **Bluetooth[®] Devices**
- **Li-Ion Operated Handheld Products**
- **WLAN and Other PC Add-on Cards**

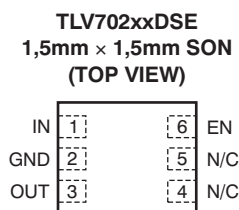
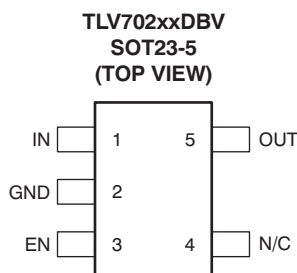

DESCRIPTION

The TLV702xx series of low-dropout (LDO) linear regulators are low quiescent current devices with excellent line and load transient performance. These LDOs are designed for power-sensitive applications. A precision bandgap and error amplifier provides overall 2% accuracy. Low output noise, very high power-supply rejection ratio (PSRR), and low-dropout voltage make this series of devices ideal for a wide selection of battery-operated handheld equipment. All device versions have thermal shutdown and current limit for safety.

Furthermore, these devices are stable with an effective output capacitance of only 0.1 μ F. This feature enables the use of cost-effective capacitors that have higher bias voltages and temperature derating. The devices regulate to specified accuracy with no output load.

The TLV702xxP series also provides an active pulldown circuit to quickly discharge the outputs.

The TLV702xx series of LDO linear regulators are available in SOT23-5 and 1,5mm \times 1,5mm SON-6 packages.

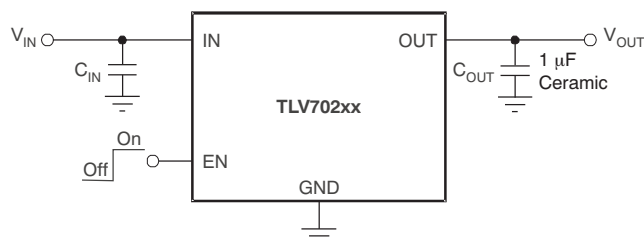

**Typical Application Circuit
(Fixed-Voltage Versions)**



Please be aware that an important notice concerning availability, standard warranty, and use in critical applications of Texas Instruments semiconductor products and disclaimers thereto appears at the end of this data sheet.

Bluetooth is a registered trademark of Bluetooth SIG.

ZigBee is a registered trademark of the ZigBee Alliance.

All other trademarks are the property of their respective owners.



This integrated circuit can be damaged by ESD. Texas Instruments recommends that all integrated circuits be handled with appropriate precautions. Failure to observe proper handling and installation procedures can cause damage.

ESD damage can range from subtle performance degradation to complete device failure. Precision integrated circuits may be more susceptible to damage because very small parametric changes could cause the device not to meet its published specifications.

ORDERING INFORMATION⁽¹⁾

| PRODUCT | V _{OUT} ⁽²⁾ |
|-------------------|---|
| TLV702xx(x)Pyyyyz | <p>XX(X) is the nominal output voltage. For output voltages with a resolution of 100 mV, two digits are used in the ordering number; otherwise, three digits are used (for example, 28 = 2.8 V; 475 = 4.75 V).</p> <p>P is optional; devices with P have an LDO regulator with an active output discharge.</p> <p>YYY is the package designator.</p> <p>Z is package quantity. Use "R" for reel (3000 pieces), and "T" for tape (250 pieces).</p> |

- (1) For the most current package and ordering information see the Package Option Addendum at the end of this document, or visit the [device product folder](#) at www.ti.com.
- (2) Output voltages from 1.2 V to 4.8 V in 50-mV increments are available. Contact factory for details and availability.

ABSOLUTE MAXIMUM RATINGS

over operating free-air temperature range (unless otherwise noted)⁽¹⁾

| | | VALUE | | UNIT |
|---|---|--------------------|------|------|
| | | MIN | MAX | |
| Voltage ⁽²⁾ | IN | -0.3 | +6.0 | V |
| | EN | -0.3 | +6.0 | V |
| | OUT | -0.3 | +6.0 | V |
| Current (source) | OUT | Internally Limited | | |
| Output short-circuit duration | | Indefinite | | |
| Temperature | Operating virtual junction, T _J | -55 | +150 | °C |
| | Storage, T _{stg} | -55 | +150 | °C |
| Electrostatic Discharge Rating ⁽³⁾ | Human Body Model (HBM) QSS 009-105 (JESD22-A114A) | | 2 | kV |
| | Charge Device Model (CDM) QSS 009-147 (JESD22-C101B.01) | | 500 | V |

- (1) Stresses beyond those listed under *absolute maximum ratings* may cause permanent damage to the device. These are stress ratings only, and functional operation of the device at these or any other conditions beyond those indicated under *recommended operating conditions* is not implied. Exposure to absolute-maximum-rated conditions for extended periods may affect device reliability.
- (2) All voltages are with respect to network ground terminal.
- (3) ESD testing is performed according to the respective JESD22 JEDEC standard.

DISSIPATION RATINGS⁽¹⁾

| PACKAGE | R _{θJA} | T _A < +25°C | T _A = +70°C | T _A = +85°C |
|---------|------------------|------------------------|------------------------|------------------------|
| DBV | 200°C/W | 500mW | 275mW | 200mW |
| DSE | 180°C/W | 555mW | 305mW | 222mW |

- (1) For board details, see the [Thermal Information](#) section.

ELECTRICAL CHARACTERISTICS

At $V_{IN} = V_{OUT(TYP)} + 0.5\text{ V}$ or 2.0 V (whichever is greater); $I_{OUT} = 10\text{ mA}$, $V_{EN} = 0.9\text{ V}$, $C_{OUT} = 1.0\text{ }\mu\text{F}$, and $T_J = -40^\circ\text{C}$ to $+125^\circ\text{C}$, unless otherwise noted. Typical values are at $T_J = +25^\circ\text{C}$.

| PARAMETER | | TEST CONDITIONS | MIN | TYP | MAX | UNIT |
|-----------------------------|--|---|-----|------|----------|---------------------|
| V_{IN} | Input voltage range | | 2.0 | | 5.5 | V |
| V_{OUT} | DC output accuracy | $-40^\circ\text{C} \leq T_J \leq +125^\circ\text{C}$ | -2 | 0.5 | +2 | % |
| $\Delta V_O/\Delta V_{IN}$ | Line regulation | $V_{OUT(NOM)} + 0.5\text{ V} \leq V_{IN} \leq 5.5\text{ V}$, $I_{OUT} = 10\text{ mA}$ | | 1 | 5 | mV |
| $\Delta V_O/\Delta I_{OUT}$ | Load regulation | $0\text{ mA} \leq I_{OUT} \leq 300\text{ mA}$ | | 1 | 15 | mV |
| V_{DO} | Dropout voltage ⁽¹⁾ | $V_{IN} = 0.98 \times V_{OUT(NOM)}$, $I_{OUT} = 50\text{ mA}$, $V_{OUT} = 2.8\text{ V}$ | | 37 | | mV |
| | | $V_{IN} = 0.98 \times V_{OUT(NOM)}$, $I_{OUT} = 100\text{ mA}$, $V_{OUT} = 2.8\text{ V}$ | | 75 | | mV |
| | | $V_{IN} = 0.98 \times V_{OUT(NOM)}$, $I_{OUT} = 300\text{ mA}$, $V_{OUT} = 2.35\text{ V}$ | | 260 | 375 | mV |
| I_{CL} | Output current limit | $V_{OUT} = 0.9 \times V_{OUT(NOM)}$ | 320 | 500 | 860 | mA |
| I_{GND} | Ground pin current | $I_{OUT} = 0\text{ mA}$ | | 35 | 55 | μA |
| | | $I_{OUT} = 300\text{ mA}$, $V_{IN} = V_{OUT} + 0.5\text{ V}$ | | 370 | | μA |
| I_{SHDN} | Ground pin current (shutdown) | $V_{EN} \leq 0.4\text{ V}$, $V_{IN} = 2.0\text{ V}$ | | 400 | | nA |
| | | $V_{EN} \leq 0.4\text{ V}$, $2.0\text{ V} \leq V_{IN} \leq 4.5\text{ V}$, $T_J = -40^\circ\text{C}$ to $+85^\circ\text{C}$ | | 1 | 2 | μA |
| PSRR | Power-supply rejection ratio | $V_{IN} = 2.3\text{ V}$, $V_{OUT} = 1.8\text{ V}$, $I_{OUT} = 10\text{ mA}$, $f = 1\text{ kHz}$ | | 68 | | dB |
| V_N | Output noise voltage | BW = 100 Hz to 100 kHz, $V_{IN} = 2.3\text{ V}$, $V_{OUT} = 1.8\text{ V}$, $I_{OUT} = 10\text{ mA}$ | | 48 | | μV_{RMS} |
| t_{STR} | Startup time ⁽²⁾ | $C_{OUT} = 1.0\text{ }\mu\text{F}$, $I_{OUT} = 300\text{ mA}$ | | 100 | | μs |
| $V_{EN(HI)}$ | Enable pin high (enabled) | | 0.9 | | V_{IN} | V |
| $V_{EN(LO)}$ | Enable pin low (disabled) | | 0 | | 0.4 | V |
| I_{EN} | Enable pin current | $V_{IN} = V_{EN} = 5.5\text{ V}$ | | 0.04 | | μA |
| UVLO | Undervoltage lockout | V_{IN} rising | | 1.9 | | V |
| $R_{DISCHARGE}$ | Active pulldown resistance (TLV702xxP only) | $V_{EN} = 0\text{ V}$ | | 120 | | Ω |
| T_{SD} | Thermal shutdown temperature | Shutdown, temperature increasing | | +165 | | $^\circ\text{C}$ |
| | | Reset, temperature decreasing | | +145 | | $^\circ\text{C}$ |
| T_J | Operating junction temperature | | -40 | | +125 | $^\circ\text{C}$ |

(1) V_{DO} is measured for devices with $V_{OUT(NOM)} \geq 2.35\text{ V}$.

(2) Startup time = time from EN assertion to $0.98 \times V_{OUT(NOM)}$.

FUNCTIONAL BLOCK DIAGRAMS

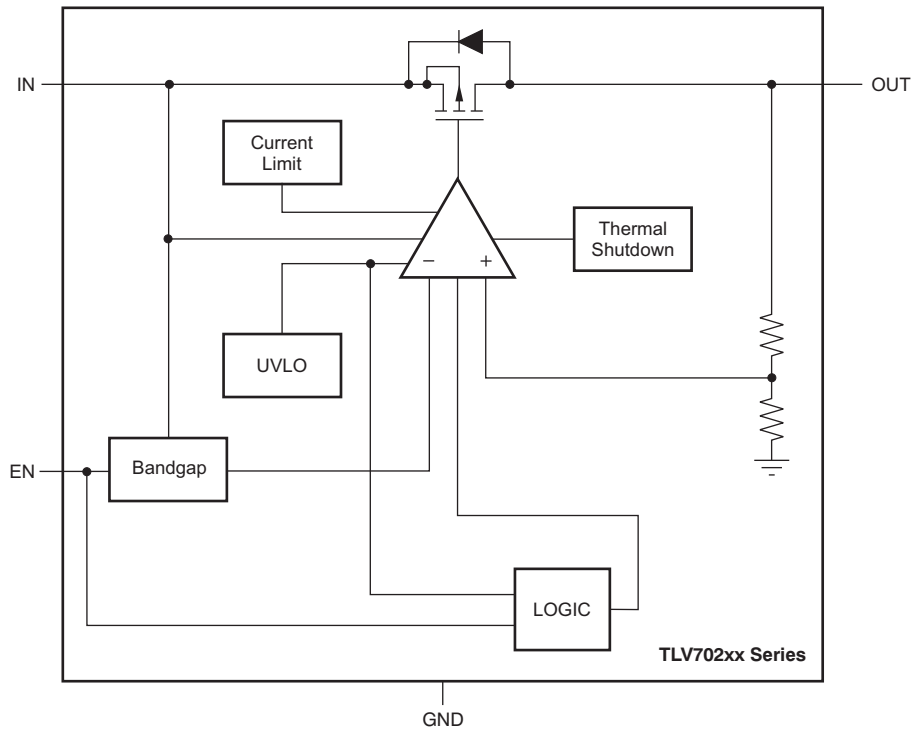

Figure 1. TLV702xx

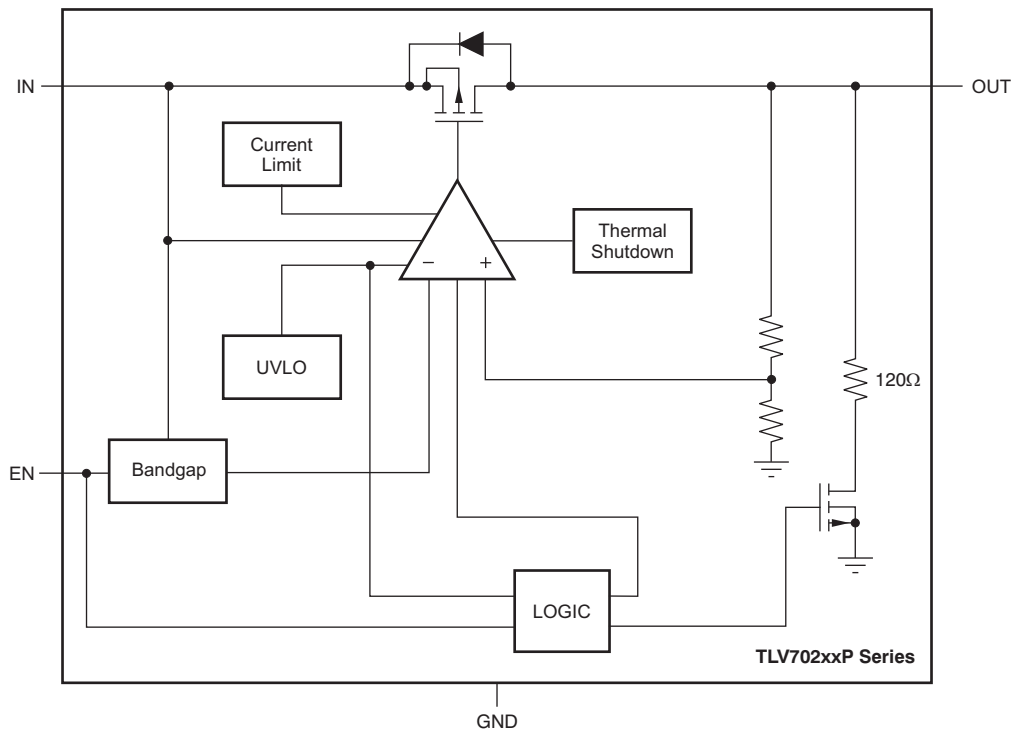
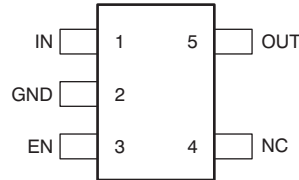

Figure 2. TLV702xxP

PIN CONFIGURATIONS

**DBV PACKAGE
SOT23-5
(TOP VIEW)**



**DSE PACKAGE
1,5mm × 1,5mm SON-6
(TOP VIEW)**

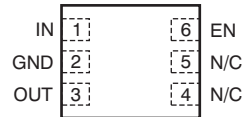

PIN DESCRIPTIONS

| PIN NAME | SOT23-5 DBV | SON-6 DSE | DESCRIPTION |
|----------|-------------|-----------|--|
| IN | 1 | 1 | Input pin. A small 1- μ F ceramic capacitor is recommended from this pin to ground to assure stability and good transient performance. See Input and Output Capacitor Requirements in the <i>Application Information</i> section for more details. |
| GND | 2 | 2 | Ground pin |
| EN | 3 | 6 | Enable pin. Driving EN over 0.9 V turns on the regulator. Driving EN below 0.4 V puts the regulator into shutdown mode and reduces operating current to 1 μ A, nominal. For TLV702xxP, output voltage is discharged through an internal 120- Ω resistor when device is shut down. |
| NC | 4 | 4, 5 | No connection. This pin can be tied to ground to improve thermal dissipation. |
| OUT | 5 | 3 | Regulated output voltage pin. A small 1- μ F ceramic capacitor is needed from this pin to ground to assure stability. See Input and Output Capacitor Requirements in the <i>Application Information</i> section for more details. |

TYPICAL CHARACTERISTICS

Over operating temperature range ($T_J = -40^{\circ}\text{C}$ to $+125^{\circ}\text{C}$), $V_{IN} = V_{OUT(TYP)} + 0.5\text{ V}$ or 2.0 V , whichever is greater; $I_{OUT} = 10\text{ mA}$, $V_{EN} = V_{IN}$, $C_{OUT} = 1.0\text{ }\mu\text{F}$, unless otherwise noted. Typical values are at $T_J = +25^{\circ}\text{C}$.

LINE REGULATION

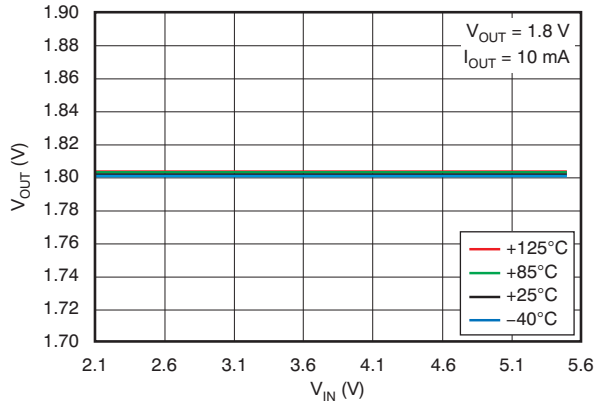

Figure 3.

LINE REGULATION

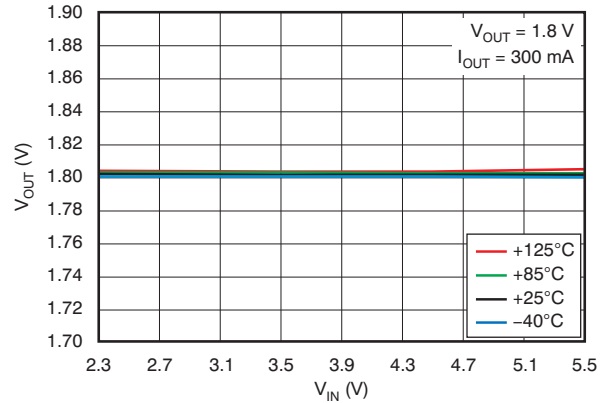

Figure 4.

LOAD REGULATION

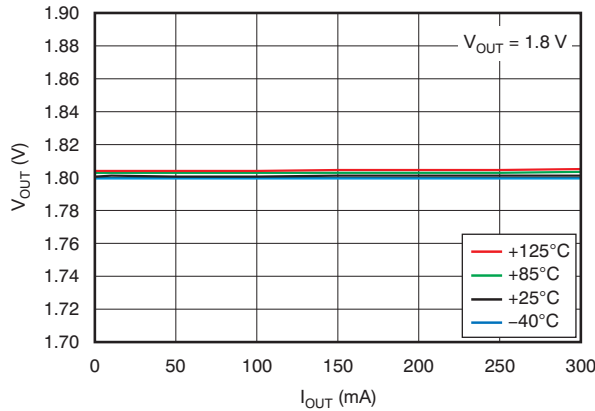

Figure 5.

DROPOUT VOLTAGE vs INPUT VOLTAGE

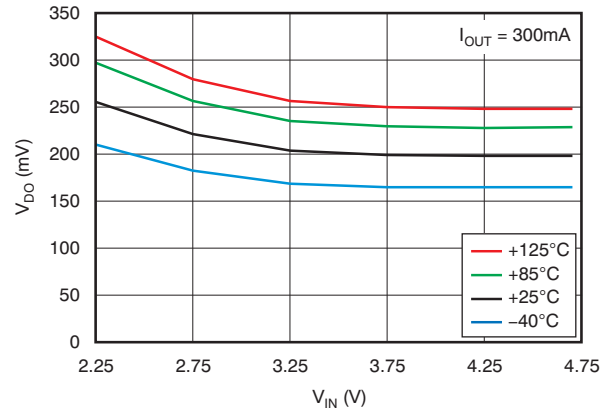

Figure 6.

DROPOUT VOLTAGE vs OUTPUT CURRENT

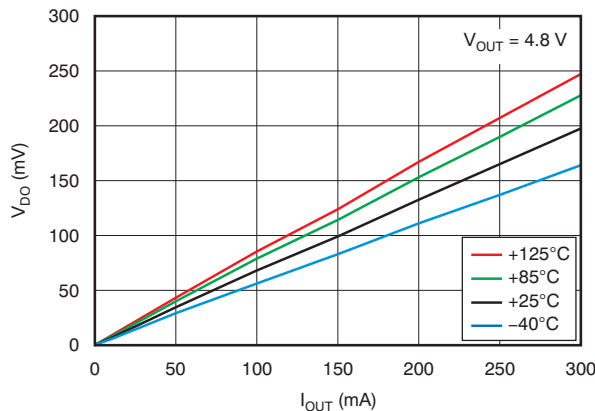

Figure 7.

OUTPUT VOLTAGE vs TEMPERATURE

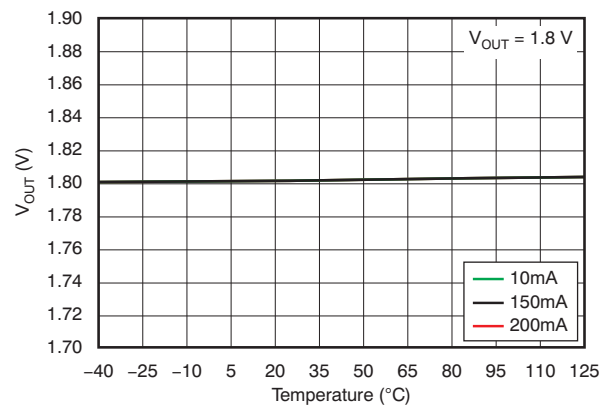

Figure 8.

TYPICAL CHARACTERISTICS (continued)

Over operating temperature range ($T_J = -40^\circ\text{C}$ to $+125^\circ\text{C}$), $V_{IN} = V_{OUT(TYP)} + 0.5\text{ V}$ or 2.0 V , whichever is greater; $I_{OUT} = 10\text{ mA}$, $V_{EN} = V_{IN}$, $C_{OUT} = 1.0\ \mu\text{F}$, unless otherwise noted. Typical values are at $T_J = +25^\circ\text{C}$.

GROUND PIN CURRENT vs INPUT VOLTAGE

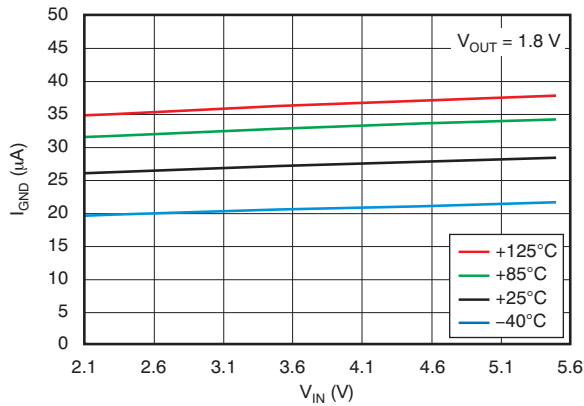

Figure 9.

GROUND PIN CURRENT vs LOAD

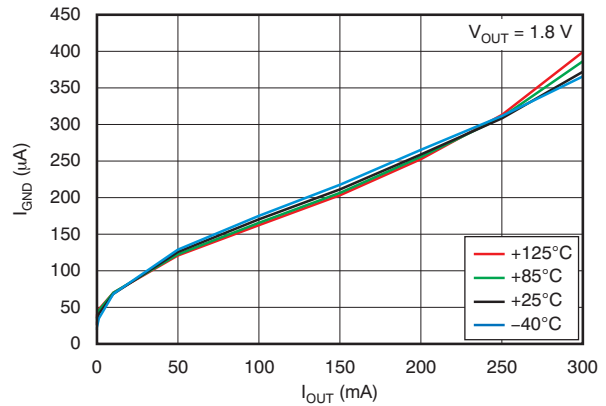

Figure 10.

GROUND PIN CURRENT vs TEMPERATURE

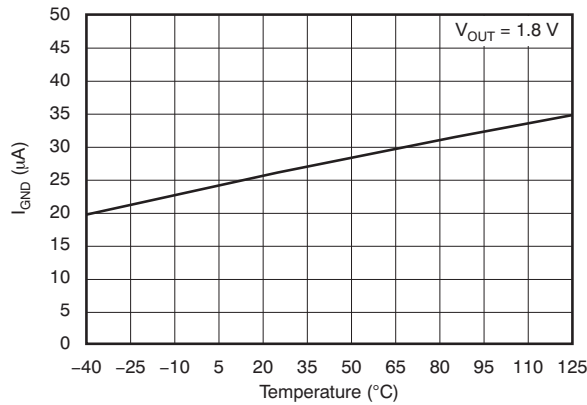

Figure 11.

SHUTDOWN CURRENT vs INPUT VOLTAGE

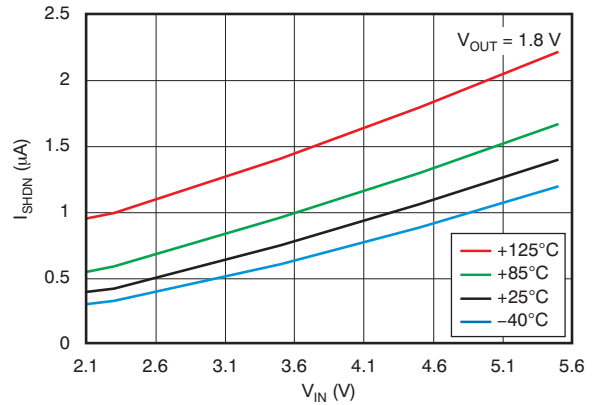

Figure 12.

CURRENT LIMIT vs INPUT VOLTAGE

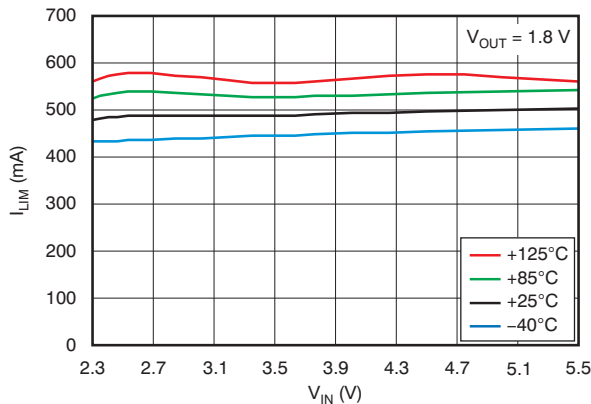

Figure 13.

POWER-SUPPLY RIPPLE REJECTION vs FREQUENCY

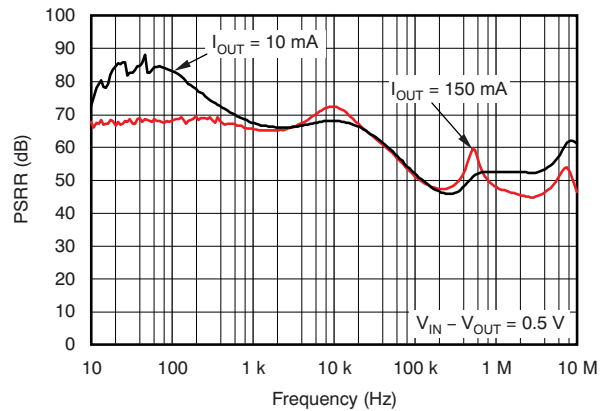

Figure 14.

TYPICAL CHARACTERISTICS (continued)

Over operating temperature range ($T_J = -40^{\circ}\text{C}$ to $+125^{\circ}\text{C}$), $V_{IN} = V_{OUT(TYP)} + 0.5\text{ V}$ or 2.0 V , whichever is greater; $I_{OUT} = 10\text{ mA}$, $V_{EN} = V_{IN}$, $C_{OUT} = 1.0\text{ }\mu\text{F}$, unless otherwise noted. Typical values are at $T_J = +25^{\circ}\text{C}$.

POWER-SUPPLY RIPPLE REJECTION vs INPUT VOLTAGE

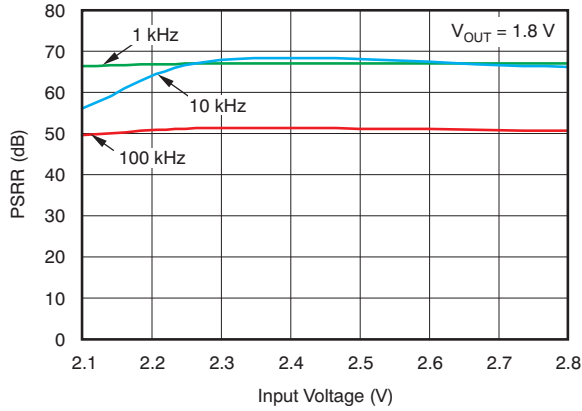

Figure 15.

OUTPUT SPECTRAL NOISE DENSITY vs FREQUENCY

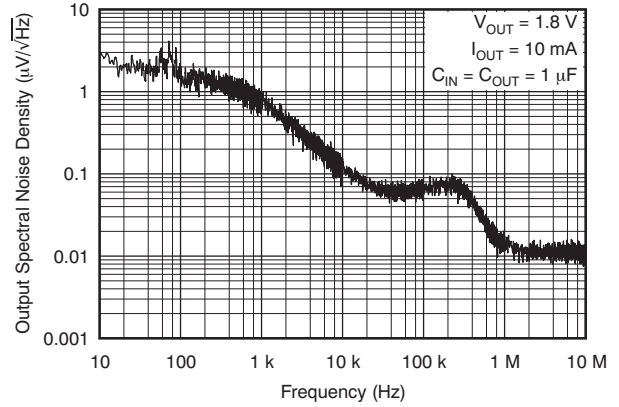

Figure 16.

LOAD TRANSIENT RESPONSE

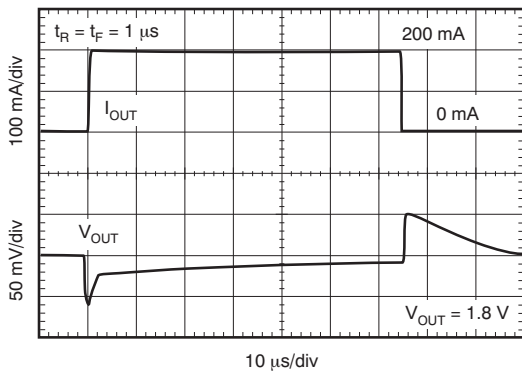

Figure 17.

LOAD TRANSIENT RESPONSE

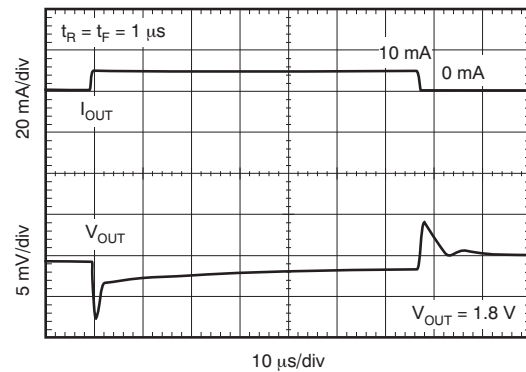

Figure 18.

LOAD TRANSIENT RESPONSE

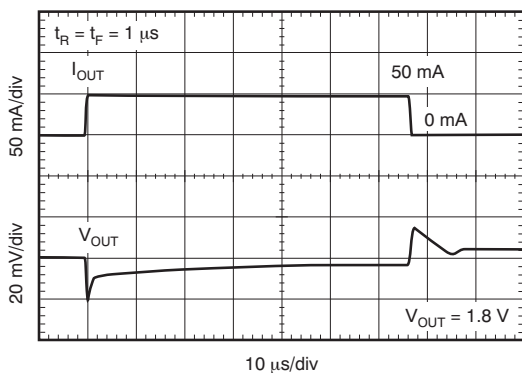

Figure 19.

LOAD TRANSIENT RESPONSE

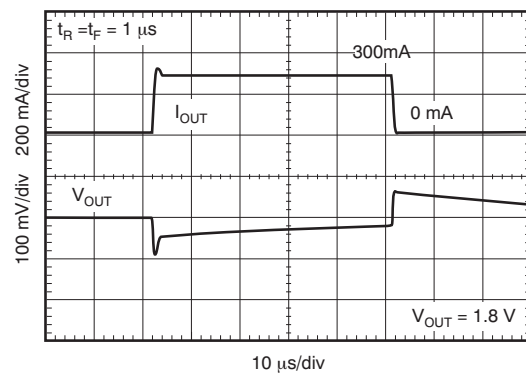

Figure 20.

TYPICAL CHARACTERISTICS (continued)

Over operating temperature range ($T_J = -40^\circ\text{C}$ to $+125^\circ\text{C}$), $V_{IN} = V_{OUT(TYP)} + 0.5\text{ V}$ or 2.0 V , whichever is greater; $I_{OUT} = 10\text{ mA}$, $V_{EN} = V_{IN}$, $C_{OUT} = 1.0\ \mu\text{F}$, unless otherwise noted. Typical values are at $T_J = +25^\circ\text{C}$.

LINE TRANSIENT RESPONSE

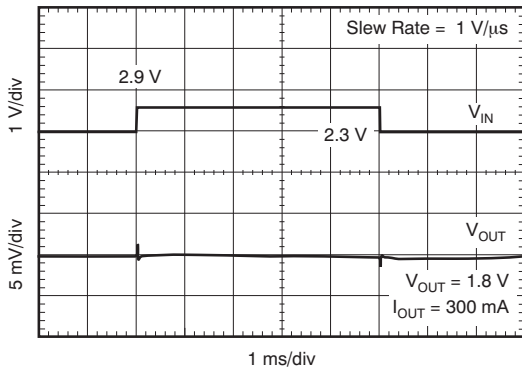

Figure 21.

LINE TRANSIENT RESPONSE

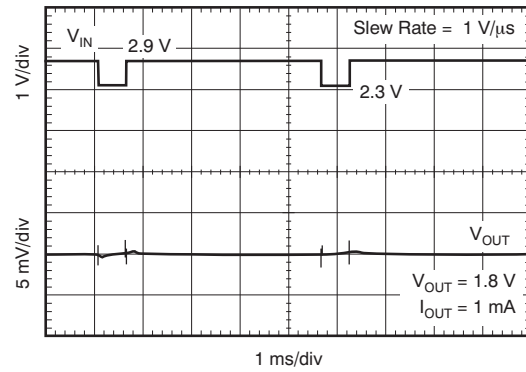

Figure 22.

LINE TRANSIENT RESPONSE

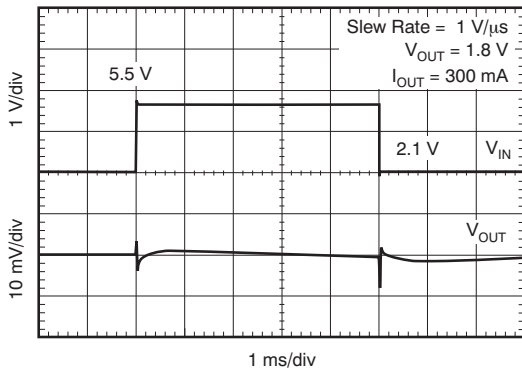

Figure 23.

V_{IN} RAMP UP, RAMP DOWN RESPONSE

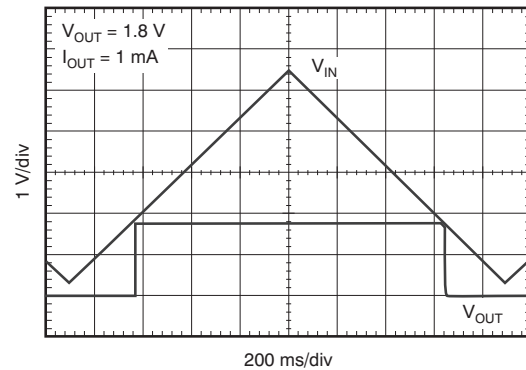

Figure 24.

APPLICATION INFORMATION

The TLV702xx belongs to a new family of next-generation value LDO regulators. These devices consume low quiescent current and deliver excellent line and load transient performance. These characteristics, combined with low noise and very good PSRR with little ($V_{IN} - V_{OUT}$) headroom, make this family of devices ideal for portable RF applications. This family of regulators offers current limit and thermal protection, and is specified from -40°C to $+125^{\circ}\text{C}$.

INPUT AND OUTPUT CAPACITOR REQUIREMENTS

1.0- μF X5R- and X7R-type ceramic capacitors are recommended because these capacitors have minimal variation in value and equivalent series resistance (ESR) over temperature.

However, the TLV702xx is designed to be stable with an *effective capacitance* of 0.1 μF or larger at the output. Thus, the device is stable with capacitors of other dielectric types as well, as long as the effective capacitance under operating bias voltage and temperature is greater than 0.1 μF . This effective capacitance refers to the capacitance that the LDO sees under operating bias voltage and temperature conditions; that is, the capacitance after taking both bias voltage and temperature derating into consideration. In addition to allowing the use of lower-cost dielectrics, this capability of being stable with 0.1- μF effective capacitance also enables the use of smaller footprint capacitors that have higher derating in size- and space-constrained applications.

NOTE: Using a 0.1- μF rated capacitor at the output of the LDO does not ensure stability because the effective capacitance under the specified operating conditions would be less than 0.1 μF . Maximum ESR should be less than 200 m Ω .

Although an input capacitor is not required for stability, it is good analog design practice to connect a 0.1- μF to 1.0- μF , low ESR capacitor across the IN pin and GND pin of the regulator. This capacitor counteracts reactive input sources and improves transient response, noise rejection, and ripple rejection. A higher-value capacitor may be necessary if large, fast rise-time load transients are anticipated, or if the device is not located close to the power source. If source impedance is more than 2 Ω , a 0.1- μF input capacitor may be necessary to ensure stability.

BOARD LAYOUT RECOMMENDATIONS TO IMPROVE PSRR AND NOISE PERFORMANCE

Input and output capacitors should be placed as close to the device pins as possible. To improve ac performance such as PSRR, output noise, and transient response, it is recommended that the board be designed with separate ground planes for V_{IN} and V_{OUT} , with the ground plane connected only at the GND pin of the device. In addition, the ground connection for the output capacitor should be connected directly to the GND pin of the device. High ESR capacitors may degrade PSRR performance.

INTERNAL CURRENT LIMIT

The TLV702xx internal current limit helps to protect the regulator during fault conditions. During current limit, the output sources a fixed amount of current that is largely independent of the output voltage. In such a case, the output voltage is not regulated, and is $V_{OUT} = I_{LIMIT} \times R_{LOAD}$. The PMOS pass transistor dissipates $(V_{IN} - V_{OUT}) \times I_{LIMIT}$ until thermal shutdown is triggered and the device turns off. As the device cools, it is turned on by the internal thermal shutdown circuit. If the fault condition continues, the device cycles between current limit and thermal shutdown. See the [Thermal Information](#) section for more details.

The PMOS pass element in the TLV702xx has a built-in body diode that conducts current when the voltage at OUT exceeds the voltage at IN. This current is not limited, so if extended reverse voltage operation is anticipated, external limiting to 5% of the rated output current is recommended.

SHUTDOWN

The enable pin (EN) is active high. The device is enabled when voltage at EN pin goes above 0.9V. This relatively lower value of voltage required to turn the LDO on can be exploited to power the LDO with a GPIO of recent processors whose GPIO Logic 1 voltage level is lower than traditional microcontrollers. The device is turned off when the EN pin is held at less than 0.4V. When shutdown capability is not required, EN can be connected to the IN pin.

The TLV702xxP version has internal active pull-down circuitry that discharges the output with a time constant of:

$$\tau = \frac{(120 \cdot R_L)}{(120 + R_L)} \cdot C_{OUT}$$

where:

- R_L = Load resistance
 - C_{OUT} = Output capacitor
- (1)

DROPOUT VOLTAGE

The TLV702xx uses a PMOS pass transistor to achieve low dropout. When $(V_{IN} - V_{OUT})$ is less than the dropout voltage (V_{DO}), the PMOS pass device is in the linear region of operation and the input-to-output resistance is the $R_{DS(ON)}$ of the PMOS pass element. V_{DO} scales approximately with output current because the PMOS device behaves as a resistor in dropout.

As with any linear regulator, PSRR and transient response are degraded as $(V_{IN} - V_{OUT})$ approaches dropout. This effect is shown in [Figure 15](#) in the [Typical Characteristics](#) section.

TRANSIENT RESPONSE

As with any regulator, increasing the size of the output capacitor reduces over-/undershoot magnitude but increases the duration of the transient response.

UNDERVOLTAGE LOCKOUT (UVLO)

The TLV702xx uses an undervoltage lockout circuit to keep the output shut off until internal circuitry is operating properly.

THERMAL INFORMATION

Thermal protection disables the output when the junction temperature rises to approximately +165°C, allowing the device to cool. When the junction temperature cools to approximately +145°C, the output circuitry is again enabled. Depending on power dissipation, thermal resistance, and ambient temperature, the thermal protection circuit may cycle on and off. This cycling limits the dissipation of the regulator, protecting it from damage as a result of overheating.

Any tendency to activate the thermal protection circuit indicates excessive power dissipation or an inadequate heatsink. For reliable operation, junction temperature should be limited to +125°C maximum.

To estimate the margin of safety in a complete design (including heatsink), increase the ambient temperature until the thermal protection is triggered; use worst-case loads and signal conditions.

The internal protection circuitry of the TLV702xx has been designed to protect against overload conditions. It was not intended to replace proper heatsinking. Continuously running the TLV702xx into thermal shutdown degrades device reliability.

POWER DISSIPATION

The ability to remove heat from the die is different for each package type, presenting different considerations in the printed circuit board (PCB) layout. The PCB area around the device that is free of other components moves the heat from the device to the ambient air.

Thermal performance data for TLV702xx were gathered using the [TLV700 evaluation module \(EVM\)](#), a 2-layer board with two ounces of copper per side. The dimensions and layout for the SOT23-5 (DBV) EVM are shown in [Figure 25](#) and [Figure 26](#). Corresponding thermal performance data are given in [Table 1](#). Note that this board has provision for soldering not only the SOT23-5 package on the bottom layer, but also the SC-70 package on the top layer. The dimensions and layout of the SON-6 (DSE) EVM is shown in [Figure 27](#) and [Figure 28](#). Corresponding thermal performance data is again given in [Table 1](#). Using heavier copper increases the effectiveness in removing heat from the device. The addition of plated through-holes to heat-dissipating layers also improves heatsink effectiveness.

Power dissipation depends on input voltage and load conditions. Power dissipation (P_D) is equal to the product of the output current and the voltage drop across the output pass element, as shown in [Equation 2](#).

$$P_D = (V_{IN} - V_{OUT}) \times I_{OUT} \quad (2)$$

PACKAGE MOUNTING

Solder pad footprint recommendations for the TLV702xx are available from the Texas Instruments web site at www.ti.com. The recommended land pattern for the DBV and DSE packages are shown in [Figure 29](#) and [Figure 30](#), respectively.

Table 1. EVM Dissipation Ratings

| PACKAGE | $R_{\theta JA}$ | $T_A < +25^\circ\text{C}$ | $T_A = +70^\circ\text{C}$ | $T_A = +85^\circ\text{C}$ |
|---------|-----------------|---------------------------|---------------------------|---------------------------|
| DBV | 200°C/W | 500mW | 275mW | 200mW |
| DSE | 180°C/W | 555mW | 305mW | 222mW |

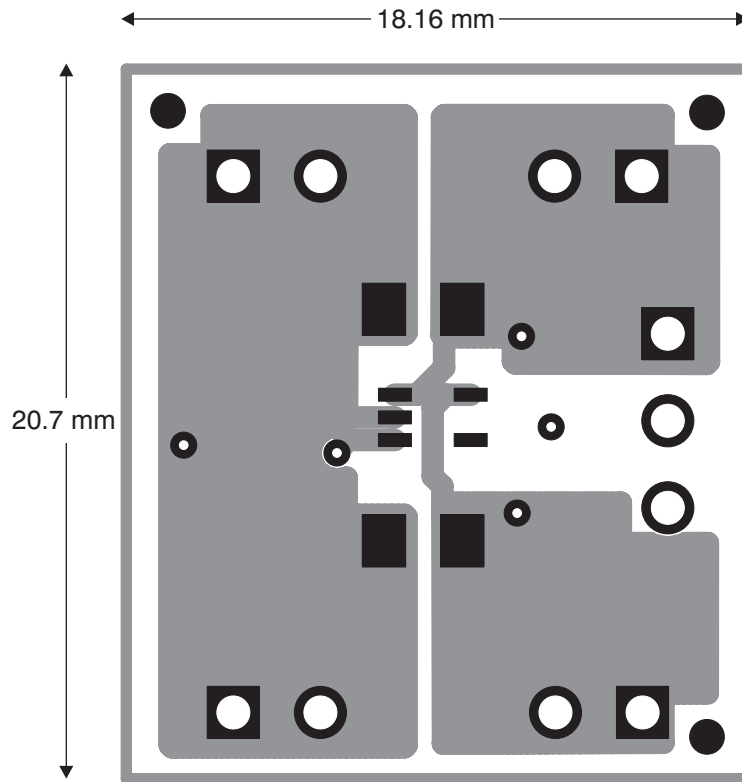

Figure 25. HPA503 EVM Top Layer

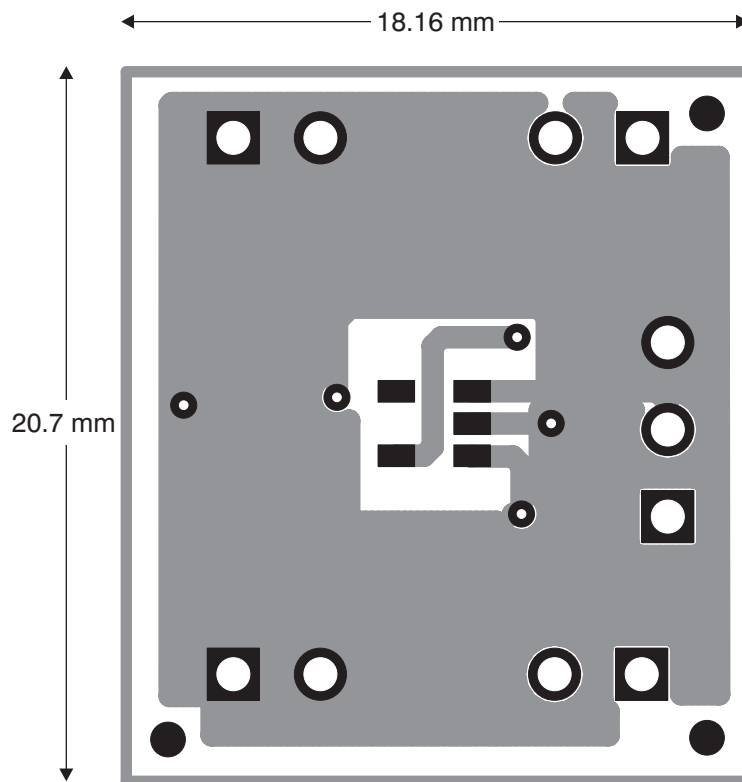

Figure 26. HPA503 EVM Bottom Layer

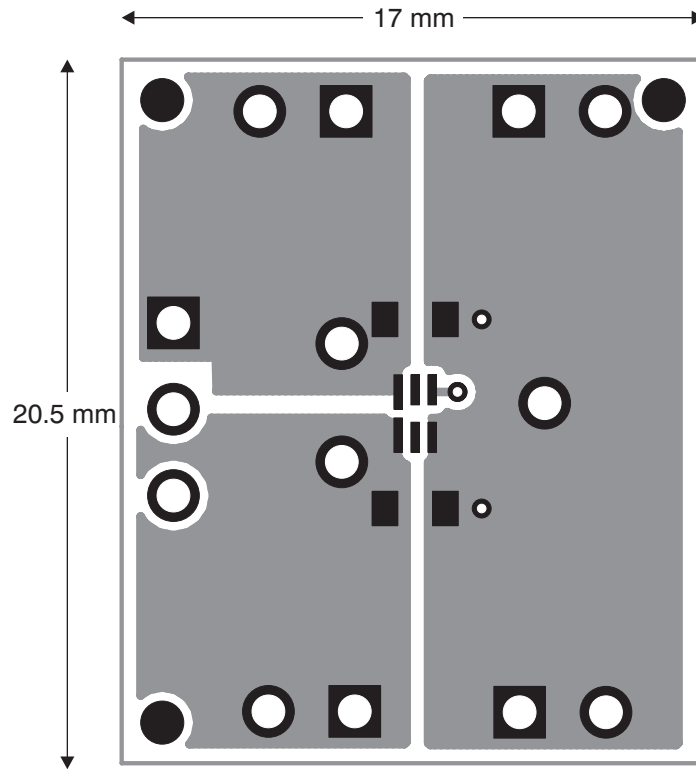

Figure 27. DSE EVM Top Layer

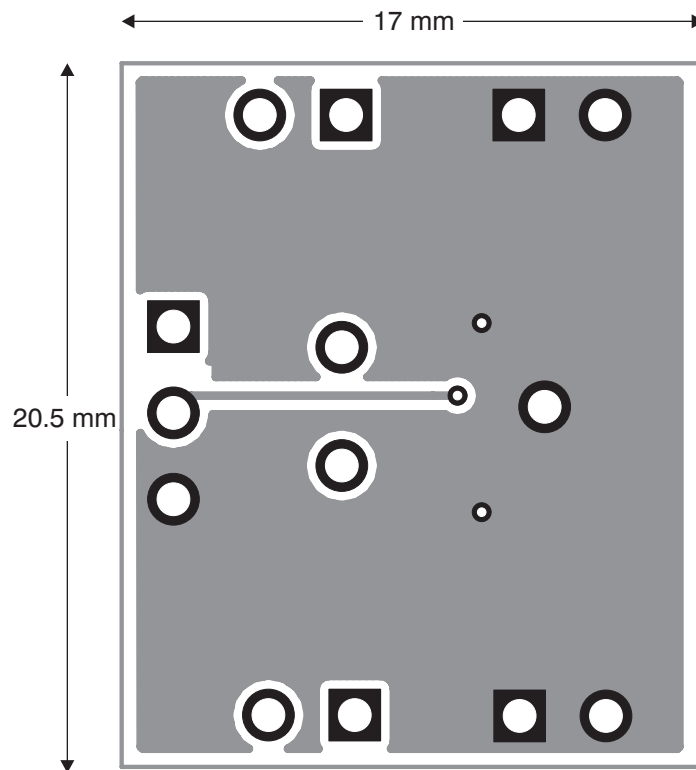
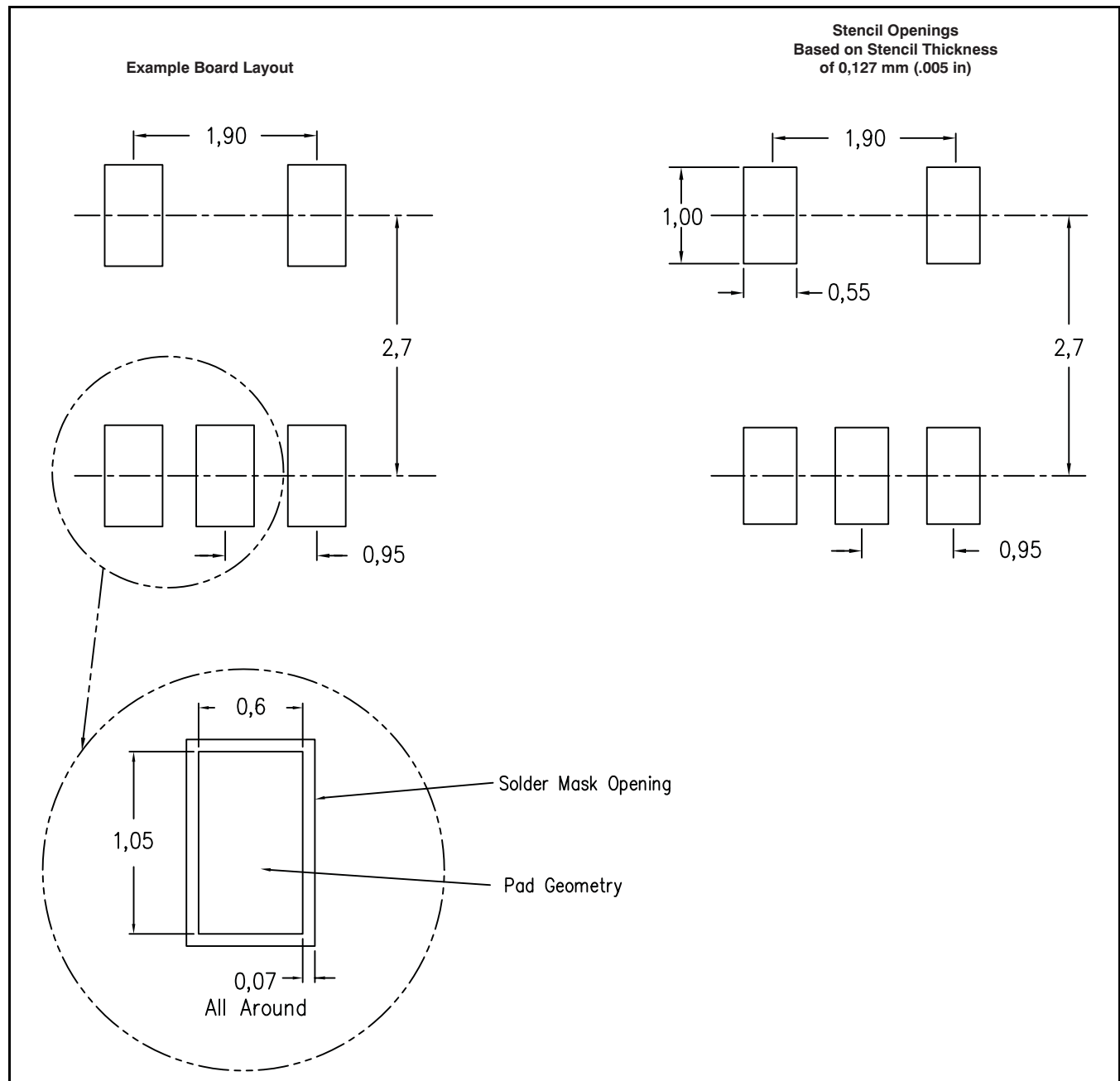
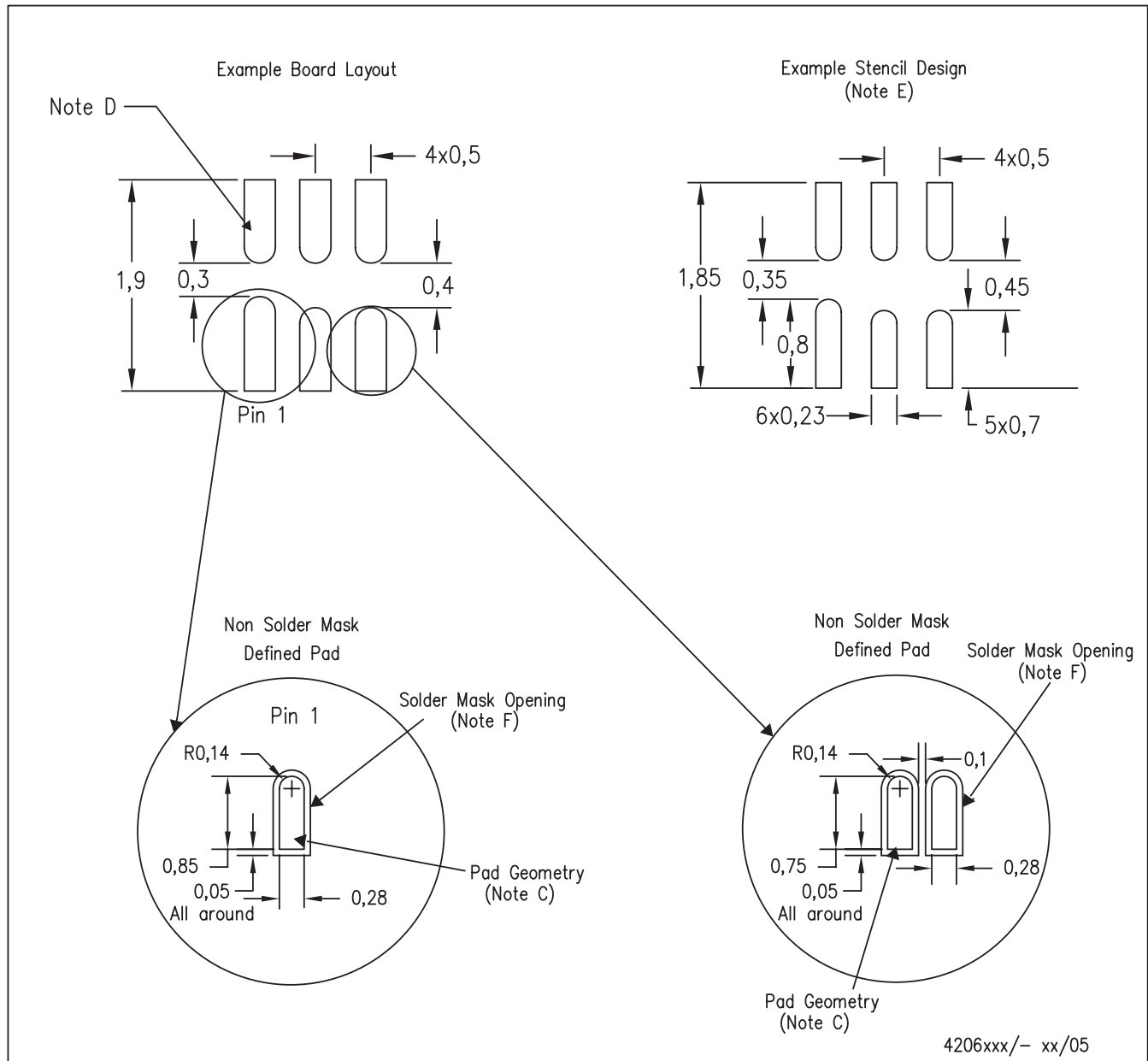

Figure 28. DSE EVM Bottom Layer



- (1) All linear dimensions are in millimeters.
- (2) Customers should place a note on the circuit board fabrication drawing not to alter the center solder mask defined pad.
- (3) Publication IPC-7351 is recommended for alternate designs.
- (4) Laser-cutting apertures with trapezoidal walls and also rounding corners will offer better paste release. Customers should contact their board assembly site for stencil design recommendations. Example stencil design based on a 50% volumetric load solder paste. Refer to IPC-7525 for other stencil recommendations.

Figure 29. Recommended Land Pattern for DBV Package



4206xxx/- xx/05

- NOTES:
- A. All linear dimensions are in millimeters.
 - B. This drawing is subject to change without notice.
 - C. Publication IPC-7351 is recommended for alternate designs.
 - D. This package is a QFN that does not have a thermal pad on the board. Refer to Application Note, Quad Flat-Pack Packages, Texas Instruments Literature No. SCBA017, SLUA271, and also the Product Data Sheets for specific thermal information, via requirements, and recommended board layout. These documents are available at www.ti.com <<http://www.ti.com>>.
 - E. Laser cutting apertures with trapezoidal walls and also rounding corners will offer better paste release. Customers should contact their board assembly site for stencil design recommendations. Refer to IPC 7525 for stencil design considerations.
 - F. Customers should contact their board fabrication site for minimum solder mask web tolerances between signal pads.

Figure 30. Recommended Land Pattern for DSE Package

REVISION HISTORY

NOTE: Page numbers for previous revisions may differ from page numbers in the current version.

| Changes from Revision A (October 2010) to Revision B | Page |
|---|-------------|
|---|-------------|

- | | |
|--|-------------------|
| • Added SON-6 (DSE) package and related references to data sheet | 1 |
|--|-------------------|

| Changes from Original (September 2010) to Revision A | Page |
|---|-------------|
|---|-------------|

- | | |
|--|-------------------|
| • Updated ordering number in <i>Ordering Information</i> table | 2 |
|--|-------------------|

PACKAGING INFORMATION

| Orderable Device | Status (1) | Package Type | Package Drawing | Pins | Package Qty | Eco Plan (2) | Lead/Ball Finish (6) | MSL Peak Temp (3) | Op Temp (°C) | Device Marking (4/5) | Samples |
|------------------|---------------|--------------|--------------------|------|----------------|----------------------------|-------------------------|----------------------|--------------|-------------------------|-------------------------|
| TLV70212DBVR | ACTIVE | SOT-23 | DBV | 5 | 3000 | Green (RoHS & no Sb/Br) | CU NIPDAU | Level-1-260C-UNLIM | -40 to 125 | QVN | Samples |
| TLV70212DBVT | ACTIVE | SOT-23 | DBV | 5 | 250 | Green (RoHS & no Sb/Br) | CU NIPDAU | Level-1-260C-UNLIM | -40 to 125 | QVN | Samples |
| TLV70215DBVR | ACTIVE | SOT-23 | DBV | 5 | 3000 | Green (RoHS & no Sb/Br) | CU NIPDAU | Level-1-260C-UNLIM | -40 to 125 | SIR | Samples |
| TLV70215DBVT | ACTIVE | SOT-23 | DBV | 5 | 250 | Green (RoHS & no Sb/Br) | CU NIPDAU | Level-1-260C-UNLIM | -40 to 125 | SIR | Samples |
| TLV70215PDBVR | ACTIVE | SOT-23 | DBV | 5 | 3000 | Green (RoHS & no Sb/Br) | CU NIPDAU | Level-1-260C-UNLIM | -40 to 125 | | Samples |
| TLV70215PDBVT | ACTIVE | SOT-23 | DBV | 5 | 250 | Green (RoHS & no Sb/Br) | CU NIPDAU | Level-1-260C-UNLIM | -40 to 125 | | Samples |
| TLV70218DBVR | ACTIVE | SOT-23 | DBV | 5 | 3000 | Green (RoHS & no Sb/Br) | CU NIPDAU | Level-1-260C-UNLIM | -40 to 125 | QUW | Samples |
| TLV70218DBVT | ACTIVE | SOT-23 | DBV | 5 | 250 | Green (RoHS & no Sb/Br) | CU NIPDAU | Level-1-260C-UNLIM | -40 to 125 | QUW | Samples |
| TLV70220PDBVR | ACTIVE | SOT-23 | DBV | 5 | 3000 | Green (RoHS & no Sb/Br) | CU NIPDAU | Level-1-260C-UNLIM | -40 to 125 | QXL | Samples |
| TLV70220PDBVT | ACTIVE | SOT-23 | DBV | 5 | 250 | Green (RoHS & no Sb/Br) | CU NIPDAU | Level-1-260C-UNLIM | -40 to 125 | QXL | Samples |
| TLV70225DBVR | ACTIVE | SOT-23 | DBV | 5 | 3000 | Green (RoHS & no Sb/Br) | CU NIPDAU | Level-1-260C-UNLIM | -40 to 125 | QVF | Samples |
| TLV70225DBVT | ACTIVE | SOT-23 | DBV | 5 | 250 | Green (RoHS & no Sb/Br) | CU NIPDAU | Level-1-260C-UNLIM | -40 to 125 | QVF | Samples |
| TLV70225DSER | ACTIVE | WSON | DSE | 6 | 3000 | Green (RoHS & no Sb/Br) | CU NIPDAU | Level-1-260C-UNLIM | -40 to 125 | SY | Samples |
| TLV70225DSET | ACTIVE | WSON | DSE | 6 | 250 | Green (RoHS & no Sb/Br) | CU NIPDAU | Level-1-260C-UNLIM | -40 to 125 | SY | Samples |
| TLV70228DBVR | ACTIVE | SOT-23 | DBV | 5 | 3000 | Green (RoHS & no Sb/Br) | CU NIPDAU | Level-1-260C-UNLIM | -40 to 125 | QUX | Samples |
| TLV70228DBVT | ACTIVE | SOT-23 | DBV | 5 | 250 | Green (RoHS & no Sb/Br) | CU NIPDAU | Level-1-260C-UNLIM | -40 to 125 | QUX | Samples |
| TLV70228DSER | ACTIVE | WSON | DSE | 6 | 3000 | Green (RoHS & no Sb/Br) | CU NIPDAU | Level-1-260C-UNLIM | -40 to 125 | VY | Samples |

| Orderable Device | Status (1) | Package Type | Package Drawing | Pins | Package Qty | Eco Plan (2) | Lead/Ball Finish (6) | MSL Peak Temp (3) | Op Temp (°C) | Device Marking (4/5) | Samples |
|------------------|---------------|--------------|-----------------|------|-------------|-------------------------|-------------------------|----------------------|--------------|-------------------------|-------------------------|
| TLV70228DSET | ACTIVE | WSON | DSE | 6 | 250 | Green (RoHS & no Sb/Br) | CU NIPDAU | Level-1-260C-UNLIM | -40 to 125 | VY | Samples |
| TLV70228PDBVR | ACTIVE | SOT-23 | DBV | 5 | 3000 | Green (RoHS & no Sb/Br) | CU NIPDAU | Level-1-260C-UNLIM | -40 to 125 | QVA | Samples |
| TLV70228PDBVT | ACTIVE | SOT-23 | DBV | 5 | 250 | Green (RoHS & no Sb/Br) | CU NIPDAU | Level-1-260C-UNLIM | -40 to 125 | QVA | Samples |
| TLV70229DSER | ACTIVE | WSON | DSE | 6 | 3000 | Green (RoHS & no Sb/Br) | CU NIPDAU | Level-1-260C-UNLIM | -40 to 125 | SZ | Samples |
| TLV70229DSET | ACTIVE | WSON | DSE | 6 | 250 | Green (RoHS & no Sb/Br) | CU NIPDAU | Level-1-260C-UNLIM | -40 to 125 | SZ | Samples |
| TLV70230DBVR | ACTIVE | SOT-23 | DBV | 5 | 3000 | Green (RoHS & no Sb/Br) | CU NIPDAU | Level-1-260C-UNLIM | -40 to 125 | QUY | Samples |
| TLV70230DBVT | ACTIVE | SOT-23 | DBV | 5 | 250 | Green (RoHS & no Sb/Br) | CU NIPDAU | Level-1-260C-UNLIM | -40 to 125 | QUY | Samples |
| TLV70231DBVR | ACTIVE | SOT-23 | DBV | 5 | 3000 | Green (RoHS & no Sb/Br) | CU NIPDAU | Level-1-260C-UNLIM | -40 to 125 | QUZ | Samples |
| TLV70231DBVT | ACTIVE | SOT-23 | DBV | 5 | 250 | Green (RoHS & no Sb/Br) | CU NIPDAU | Level-1-260C-UNLIM | -40 to 125 | QUZ | Samples |
| TLV70233DBVR | ACTIVE | SOT-23 | DBV | 5 | 3000 | Green (RoHS & no Sb/Br) | CU NIPDAU | Level-1-260C-UNLIM | -40 to 125 | QVD | Samples |
| TLV70233DBVT | ACTIVE | SOT-23 | DBV | 5 | 250 | Green (RoHS & no Sb/Br) | CU NIPDAU | Level-1-260C-UNLIM | -40 to 125 | QVD | Samples |
| TLV70233DSER | ACTIVE | WSON | DSE | 6 | 3000 | Green (RoHS & no Sb/Br) | CU NIPDAU | Level-1-260C-UNLIM | -40 to 125 | WK | Samples |
| TLV70233DSET | ACTIVE | WSON | DSE | 6 | 250 | Green (RoHS & no Sb/Br) | CU NIPDAU | Level-1-260C-UNLIM | -40 to 125 | WK | Samples |
| TLV70233PDBVR | ACTIVE | SOT-23 | DBV | 5 | 3000 | Green (RoHS & no Sb/Br) | CU NIPDAU | Level-1-260C-UNLIM | -40 to 125 | | Samples |
| TLV70233PDBVT | ACTIVE | SOT-23 | DBV | 5 | 250 | Green (RoHS & no Sb/Br) | CU NIPDAU | Level-1-260C-UNLIM | -40 to 125 | | Samples |
| TLV70235DBVR | ACTIVE | SOT-23 | DBV | 5 | 3000 | Green (RoHS & no Sb/Br) | CU NIPDAU | Level-1-260C-UNLIM | -40 to 125 | SDT | Samples |
| TLV70235DBVT | ACTIVE | SOT-23 | DBV | 5 | 250 | Green (RoHS & no Sb/Br) | CU NIPDAU | Level-1-260C-UNLIM | -40 to 125 | SDT | Samples |
| TLV70236DSER | ACTIVE | WSON | DSE | 6 | 3000 | Green (RoHS & no Sb/Br) | CU NIPDAU | Level-1-260C-UNLIM | -40 to 125 | VZ | Samples |

| Orderable Device | Status (1) | Package Type | Package Drawing | Pins | Package Qty | Eco Plan (2) | Lead/Ball Finish (6) | MSL Peak Temp (3) | Op Temp (°C) | Device Marking (4/5) | Samples |
|------------------|---------------|--------------|-----------------|------|-------------|-------------------------|-------------------------|----------------------|--------------|-------------------------|-------------------------|
| TLV70236DSET | ACTIVE | WSON | DSE | 6 | 250 | Green (RoHS & no Sb/Br) | CU NIPDAU | Level-1-260C-UNLIM | -40 to 125 | VZ | Samples |
| TLV70237DBVR | ACTIVE | SOT-23 | DBV | 5 | 3000 | Green (RoHS & no Sb/Br) | CU NIPDAU | Level-1-260C-UNLIM | -40 to 125 | QXR | Samples |
| TLV70237DBVT | ACTIVE | SOT-23 | DBV | 5 | 250 | Green (RoHS & no Sb/Br) | CU NIPDAU | Level-1-260C-UNLIM | -40 to 125 | QXR | Samples |
| TLV70237DSER | ACTIVE | WSON | DSE | 6 | 3000 | Green (RoHS & no Sb/Br) | CU NIPDAU | Level-1-260C-UNLIM | -40 to 125 | D8 | Samples |
| TLV70237DSET | ACTIVE | WSON | DSE | 6 | 250 | Green (RoHS & no Sb/Br) | CU NIPDAU | Level-1-260C-UNLIM | -40 to 125 | D8 | Samples |
| TLV70242PDSER | ACTIVE | WSON | DSE | 6 | 3000 | Green (RoHS & no Sb/Br) | CU NIPDAU | Level-1-260C-UNLIM | -40 to 125 | B9 | Samples |
| TLV70242PDSET | ACTIVE | WSON | DSE | 6 | 250 | Green (RoHS & no Sb/Br) | CU NIPDAU | Level-1-260C-UNLIM | -40 to 125 | B9 | Samples |
| TLV70245DBVR | ACTIVE | SOT-23 | DBV | 5 | 3000 | Green (RoHS & no Sb/Br) | CU NIPDAU | Level-1-260C-UNLIM | -40 to 125 | SCK | Samples |
| TLV70245DBVT | ACTIVE | SOT-23 | DBV | 5 | 250 | Green (RoHS & no Sb/Br) | CU NIPDAU | Level-1-260C-UNLIM | -40 to 125 | SCK | Samples |
| TLV702475DBVR | ACTIVE | SOT-23 | DBV | 5 | 3000 | Green (RoHS & no Sb/Br) | CU NIPDAU | Level-1-260C-UNLIM | -40 to 125 | QWJ | Samples |
| TLV702475DBVT | ACTIVE | SOT-23 | DBV | 5 | 250 | Green (RoHS & no Sb/Br) | CU NIPDAU | Level-1-260C-UNLIM | -40 to 125 | QWJ | Samples |

(1) The marketing status values are defined as follows:

ACTIVE: Product device recommended for new designs.

LIFEBUY: TI has announced that the device will be discontinued, and a lifetime-buy period is in effect.

NRND: Not recommended for new designs. Device is in production to support existing customers, but TI does not recommend using this part in a new design.

PREVIEW: Device has been announced but is not in production. Samples may or may not be available.

OBSELETE: TI has discontinued the production of the device.

(2) Eco Plan - The planned eco-friendly classification: Pb-Free (RoHS), Pb-Free (RoHS Exempt), or Green (RoHS & no Sb/Br) - please check <http://www.ti.com/productcontent> for the latest availability information and additional product content details.

TBD: The Pb-Free/Green conversion plan has not been defined.

Pb-Free (RoHS): TI's terms "Lead-Free" or "Pb-Free" mean semiconductor products that are compatible with the current RoHS requirements for all 6 substances, including the requirement that lead not exceed 0.1% by weight in homogeneous materials. Where designed to be soldered at high temperatures, TI Pb-Free products are suitable for use in specified lead-free processes.

Pb-Free (RoHS Exempt): This component has a RoHS exemption for either 1) lead-based flip-chip solder bumps used between the die and package, or 2) lead-based die adhesive used between the die and leadframe. The component is otherwise considered Pb-Free (RoHS compatible) as defined above.

Green (RoHS & no Sb/Br): TI defines "Green" to mean Pb-Free (RoHS compatible), and free of Bromine (Br) and Antimony (Sb) based flame retardants (Br or Sb do not exceed 0.1% by weight in homogeneous material)

(3) MSL, Peak Temp. - The Moisture Sensitivity Level rating according to the JEDEC industry standard classifications, and peak solder temperature.

(4) There may be additional marking, which relates to the logo, the lot trace code information, or the environmental category on the device.

(5) Multiple Device Markings will be inside parentheses. Only one Device Marking contained in parentheses and separated by a "~" will appear on a device. If a line is indented then it is a continuation of the previous line and the two combined represent the entire Device Marking for that device.

(6) Lead/Ball Finish - Orderable Devices may have multiple material finish options. Finish options are separated by a vertical ruled line. Lead/Ball Finish values may wrap to two lines if the finish value exceeds the maximum column width.

Important Information and Disclaimer: The information provided on this page represents TI's knowledge and belief as of the date that it is provided. TI bases its knowledge and belief on information provided by third parties, and makes no representation or warranty as to the accuracy of such information. Efforts are underway to better integrate information from third parties. TI has taken and continues to take reasonable steps to provide representative and accurate information but may not have conducted destructive testing or chemical analysis on incoming materials and chemicals. TI and TI suppliers consider certain information to be proprietary, and thus CAS numbers and other limited information may not be available for release.

In no event shall TI's liability arising out of such information exceed the total purchase price of the TI part(s) at issue in this document sold by TI to Customer on an annual basis.

OTHER QUALIFIED VERSIONS OF TLV70228 :

- Automotive: [TLV70228-Q1](#)

NOTE: Qualified Version Definitions:

- Automotive - Q100 devices qualified for high-reliability automotive applications targeting zero defects

TAPE AND REEL INFORMATION



QUADRANT ASSIGNMENTS FOR PIN 1 ORIENTATION IN TAPE



*All dimensions are nominal

| Device | Package Type | Package Drawing | Pins | SPQ | Reel Diameter (mm) | Reel Width W1 (mm) | A0 (mm) | B0 (mm) | K0 (mm) | P1 (mm) | W (mm) | Pin1 Quadrant |
|---------------|--------------|-----------------|------|------|--------------------|--------------------|---------|---------|---------|---------|--------|---------------|
| TLV70212DBVR | SOT-23 | DBV | 5 | 3000 | 178.0 | 9.0 | 3.23 | 3.17 | 1.37 | 4.0 | 8.0 | Q3 |
| TLV70212DBVR | SOT-23 | DBV | 5 | 3000 | 180.0 | 8.4 | 3.23 | 3.17 | 1.37 | 4.0 | 8.0 | Q3 |
| TLV70212DBVT | SOT-23 | DBV | 5 | 250 | 178.0 | 8.4 | 3.23 | 3.17 | 1.37 | 4.0 | 8.0 | Q3 |
| TLV70212DBVT | SOT-23 | DBV | 5 | 250 | 180.0 | 8.4 | 3.23 | 3.17 | 1.37 | 4.0 | 8.0 | Q3 |
| TLV70215DBVR | SOT-23 | DBV | 5 | 3000 | 178.0 | 9.0 | 3.23 | 3.17 | 1.37 | 4.0 | 8.0 | Q3 |
| TLV70215DBVT | SOT-23 | DBV | 5 | 250 | 178.0 | 8.4 | 3.23 | 3.17 | 1.37 | 4.0 | 8.0 | Q3 |
| TLV70215PDBVR | SOT-23 | DBV | 5 | 3000 | 178.0 | 9.0 | 3.23 | 3.17 | 1.37 | 4.0 | 8.0 | Q3 |
| TLV70215PDBVT | SOT-23 | DBV | 5 | 250 | 178.0 | 8.4 | 3.23 | 3.17 | 1.37 | 4.0 | 8.0 | Q3 |
| TLV70218DBVR | SOT-23 | DBV | 5 | 3000 | 178.0 | 9.0 | 3.3 | 3.2 | 1.4 | 4.0 | 8.0 | Q3 |
| TLV70218DBVT | SOT-23 | DBV | 5 | 250 | 178.0 | 8.4 | 3.3 | 3.2 | 1.4 | 4.0 | 8.0 | Q3 |
| TLV70220PDBVR | SOT-23 | DBV | 5 | 3000 | 178.0 | 9.0 | 3.23 | 3.17 | 1.37 | 4.0 | 8.0 | Q3 |
| TLV70220PDBVT | SOT-23 | DBV | 5 | 250 | 178.0 | 8.4 | 3.23 | 3.17 | 1.37 | 4.0 | 8.0 | Q3 |
| TLV70225DBVR | SOT-23 | DBV | 5 | 3000 | 178.0 | 9.0 | 3.23 | 3.17 | 1.37 | 4.0 | 8.0 | Q3 |
| TLV70225DBVR | SOT-23 | DBV | 5 | 3000 | 180.0 | 8.4 | 3.23 | 3.17 | 1.37 | 4.0 | 8.0 | Q3 |
| TLV70225DBVT | SOT-23 | DBV | 5 | 250 | 178.0 | 8.4 | 3.23 | 3.17 | 1.37 | 4.0 | 8.0 | Q3 |
| TLV70225DBVT | SOT-23 | DBV | 5 | 250 | 180.0 | 8.4 | 3.23 | 3.17 | 1.37 | 4.0 | 8.0 | Q3 |
| TLV70225DSE | WSO | DSE | 6 | 3000 | 179.0 | 8.4 | 1.8 | 1.8 | 1.0 | 4.0 | 8.0 | Q2 |
| TLV70225DSE | WSO | DSE | 6 | 250 | 179.0 | 8.4 | 1.8 | 1.8 | 1.0 | 4.0 | 8.0 | Q2 |

| Device | Package Type | Package Drawing | Pins | SPQ | Reel Diameter (mm) | Reel Width W1 (mm) | A0 (mm) | B0 (mm) | K0 (mm) | P1 (mm) | W (mm) | Pin1 Quadrant |
|---------------|--------------|-----------------|------|------|--------------------|--------------------|---------|---------|---------|---------|--------|---------------|
| TLV70228DBVR | SOT-23 | DBV | 5 | 3000 | 178.0 | 9.0 | 3.23 | 3.17 | 1.37 | 4.0 | 8.0 | Q3 |
| TLV70228DBVR | SOT-23 | DBV | 5 | 3000 | 180.0 | 8.4 | 3.23 | 3.17 | 1.37 | 4.0 | 8.0 | Q3 |
| TLV70228DBVT | SOT-23 | DBV | 5 | 250 | 178.0 | 8.4 | 3.23 | 3.17 | 1.37 | 4.0 | 8.0 | Q3 |
| TLV70228DSE | WSON | DSE | 6 | 3000 | 179.0 | 8.4 | 1.8 | 1.8 | 1.0 | 4.0 | 8.0 | Q2 |
| TLV70228DSET | WSON | DSE | 6 | 250 | 179.0 | 8.4 | 1.8 | 1.8 | 1.0 | 4.0 | 8.0 | Q2 |
| TLV70228PDBVR | SOT-23 | DBV | 5 | 3000 | 180.0 | 8.4 | 3.23 | 3.17 | 1.37 | 4.0 | 8.0 | Q3 |
| TLV70228PDBVT | SOT-23 | DBV | 5 | 250 | 180.0 | 8.4 | 3.23 | 3.17 | 1.37 | 4.0 | 8.0 | Q3 |
| TLV70229DSE | WSON | DSE | 6 | 3000 | 180.0 | 8.4 | 1.83 | 1.83 | 0.89 | 4.0 | 8.0 | Q2 |
| TLV70229DSET | WSON | DSE | 6 | 250 | 180.0 | 8.4 | 1.83 | 1.83 | 0.89 | 4.0 | 8.0 | Q2 |
| TLV70230DBVR | SOT-23 | DBV | 5 | 3000 | 178.0 | 9.0 | 3.23 | 3.17 | 1.37 | 4.0 | 8.0 | Q3 |
| TLV70230DBVT | SOT-23 | DBV | 5 | 250 | 178.0 | 8.4 | 3.23 | 3.17 | 1.37 | 4.0 | 8.0 | Q3 |
| TLV70231DBVR | SOT-23 | DBV | 5 | 3000 | 178.0 | 9.0 | 3.23 | 3.17 | 1.37 | 4.0 | 8.0 | Q3 |
| TLV70231DBVT | SOT-23 | DBV | 5 | 250 | 178.0 | 8.4 | 3.23 | 3.17 | 1.37 | 4.0 | 8.0 | Q3 |
| TLV70233DBVR | SOT-23 | DBV | 5 | 3000 | 178.0 | 9.0 | 3.23 | 3.17 | 1.37 | 4.0 | 8.0 | Q3 |
| TLV70233DBVT | SOT-23 | DBV | 5 | 250 | 178.0 | 8.4 | 3.23 | 3.17 | 1.37 | 4.0 | 8.0 | Q3 |
| TLV70233DSE | WSON | DSE | 6 | 3000 | 179.0 | 8.4 | 1.8 | 1.8 | 1.0 | 4.0 | 8.0 | Q2 |
| TLV70233DSET | WSON | DSE | 6 | 250 | 179.0 | 8.4 | 1.8 | 1.8 | 1.0 | 4.0 | 8.0 | Q2 |
| TLV70233PDBVR | SOT-23 | DBV | 5 | 3000 | 178.0 | 9.0 | 3.23 | 3.17 | 1.37 | 4.0 | 8.0 | Q3 |
| TLV70233PDBVT | SOT-23 | DBV | 5 | 250 | 178.0 | 8.4 | 3.23 | 3.17 | 1.37 | 4.0 | 8.0 | Q3 |
| TLV70235DBVR | SOT-23 | DBV | 5 | 3000 | 178.0 | 9.0 | 3.23 | 3.17 | 1.37 | 4.0 | 8.0 | Q3 |
| TLV70235DBVT | SOT-23 | DBV | 5 | 250 | 178.0 | 8.4 | 3.23 | 3.17 | 1.37 | 4.0 | 8.0 | Q3 |
| TLV70236DSE | WSON | DSE | 6 | 3000 | 179.0 | 8.4 | 1.8 | 1.8 | 1.0 | 4.0 | 8.0 | Q2 |
| TLV70236DSET | WSON | DSE | 6 | 250 | 179.0 | 8.4 | 1.8 | 1.8 | 1.0 | 4.0 | 8.0 | Q2 |
| TLV70237DBVR | SOT-23 | DBV | 5 | 3000 | 178.0 | 9.0 | 3.23 | 3.17 | 1.37 | 4.0 | 8.0 | Q3 |
| TLV70237DBVT | SOT-23 | DBV | 5 | 250 | 178.0 | 8.4 | 3.23 | 3.17 | 1.37 | 4.0 | 8.0 | Q3 |
| TLV70237DSE | WSON | DSE | 6 | 3000 | 180.0 | 8.4 | 1.83 | 1.83 | 0.89 | 4.0 | 8.0 | Q2 |
| TLV70237DSET | WSON | DSE | 6 | 250 | 180.0 | 8.4 | 1.83 | 1.83 | 0.89 | 4.0 | 8.0 | Q2 |
| TLV70242PDSE | WSON | DSE | 6 | 3000 | 180.0 | 8.4 | 1.83 | 1.83 | 0.89 | 4.0 | 8.0 | Q2 |
| TLV70242PDSET | WSON | DSE | 6 | 250 | 180.0 | 8.4 | 1.83 | 1.83 | 0.89 | 4.0 | 8.0 | Q2 |
| TLV70245DBVR | SOT-23 | DBV | 5 | 3000 | 178.0 | 9.0 | 3.23 | 3.17 | 1.37 | 4.0 | 8.0 | Q3 |
| TLV70245DBVT | SOT-23 | DBV | 5 | 250 | 178.0 | 8.4 | 3.3 | 3.2 | 1.4 | 4.0 | 8.0 | Q3 |
| TLV702475DBVR | SOT-23 | DBV | 5 | 3000 | 178.0 | 9.0 | 3.23 | 3.17 | 1.37 | 4.0 | 8.0 | Q3 |
| TLV702475DBVT | SOT-23 | DBV | 5 | 250 | 178.0 | 8.4 | 3.23 | 3.17 | 1.37 | 4.0 | 8.0 | Q3 |

TAPE AND REEL BOX DIMENSIONS

*All dimensions are nominal

| Device | Package Type | Package Drawing | Pins | SPQ | Length (mm) | Width (mm) | Height (mm) |
|---------------|--------------|-----------------|------|------|-------------|------------|-------------|
| TLV70212DBVR | SOT-23 | DBV | 5 | 3000 | 180.0 | 180.0 | 18.0 |
| TLV70212DBVR | SOT-23 | DBV | 5 | 3000 | 202.0 | 201.0 | 28.0 |
| TLV70212DBVT | SOT-23 | DBV | 5 | 250 | 180.0 | 180.0 | 18.0 |
| TLV70212DBVT | SOT-23 | DBV | 5 | 250 | 202.0 | 201.0 | 28.0 |
| TLV70215DBVR | SOT-23 | DBV | 5 | 3000 | 180.0 | 180.0 | 18.0 |
| TLV70215DBVT | SOT-23 | DBV | 5 | 250 | 180.0 | 180.0 | 18.0 |
| TLV70215PDBVR | SOT-23 | DBV | 5 | 3000 | 180.0 | 180.0 | 18.0 |
| TLV70215PDBVT | SOT-23 | DBV | 5 | 250 | 180.0 | 180.0 | 18.0 |
| TLV70218DBVR | SOT-23 | DBV | 5 | 3000 | 180.0 | 180.0 | 18.0 |
| TLV70218DBVT | SOT-23 | DBV | 5 | 250 | 180.0 | 180.0 | 18.0 |
| TLV70220PDBVR | SOT-23 | DBV | 5 | 3000 | 180.0 | 180.0 | 18.0 |
| TLV70220PDBVT | SOT-23 | DBV | 5 | 250 | 180.0 | 180.0 | 18.0 |
| TLV70225DBVR | SOT-23 | DBV | 5 | 3000 | 180.0 | 180.0 | 18.0 |
| TLV70225DBVR | SOT-23 | DBV | 5 | 3000 | 202.0 | 201.0 | 28.0 |
| TLV70225DBVT | SOT-23 | DBV | 5 | 250 | 180.0 | 180.0 | 18.0 |
| TLV70225DBVT | SOT-23 | DBV | 5 | 250 | 202.0 | 201.0 | 28.0 |
| TLV70225DSE | WSON | DSE | 6 | 3000 | 203.0 | 203.0 | 35.0 |
| TLV70225DSET | WSON | DSE | 6 | 250 | 203.0 | 203.0 | 35.0 |
| TLV70228DBVR | SOT-23 | DBV | 5 | 3000 | 180.0 | 180.0 | 18.0 |
| TLV70228DBVR | SOT-23 | DBV | 5 | 3000 | 202.0 | 201.0 | 28.0 |

| Device | Package Type | Package Drawing | Pins | SPQ | Length (mm) | Width (mm) | Height (mm) |
|---------------|--------------|-----------------|------|------|-------------|------------|-------------|
| TLV70228DBVT | SOT-23 | DBV | 5 | 250 | 180.0 | 180.0 | 18.0 |
| TLV70228DSER | WSON | DSE | 6 | 3000 | 203.0 | 203.0 | 35.0 |
| TLV70228DSET | WSON | DSE | 6 | 250 | 203.0 | 203.0 | 35.0 |
| TLV70228PDBVR | SOT-23 | DBV | 5 | 3000 | 202.0 | 201.0 | 28.0 |
| TLV70228PDBVT | SOT-23 | DBV | 5 | 250 | 202.0 | 201.0 | 28.0 |
| TLV70229DSER | WSON | DSE | 6 | 3000 | 202.0 | 201.0 | 28.0 |
| TLV70229DSET | WSON | DSE | 6 | 250 | 202.0 | 201.0 | 28.0 |
| TLV70230DBVR | SOT-23 | DBV | 5 | 3000 | 180.0 | 180.0 | 18.0 |
| TLV70230DBVT | SOT-23 | DBV | 5 | 250 | 180.0 | 180.0 | 18.0 |
| TLV70231DBVR | SOT-23 | DBV | 5 | 3000 | 180.0 | 180.0 | 18.0 |
| TLV70231DBVT | SOT-23 | DBV | 5 | 250 | 180.0 | 180.0 | 18.0 |
| TLV70233DBVR | SOT-23 | DBV | 5 | 3000 | 180.0 | 180.0 | 18.0 |
| TLV70233DBVT | SOT-23 | DBV | 5 | 250 | 180.0 | 180.0 | 18.0 |
| TLV70233DSER | WSON | DSE | 6 | 3000 | 203.0 | 203.0 | 35.0 |
| TLV70233DSET | WSON | DSE | 6 | 250 | 203.0 | 203.0 | 35.0 |
| TLV70233PDBVR | SOT-23 | DBV | 5 | 3000 | 180.0 | 180.0 | 18.0 |
| TLV70233PDBVT | SOT-23 | DBV | 5 | 250 | 180.0 | 180.0 | 18.0 |
| TLV70235DBVR | SOT-23 | DBV | 5 | 3000 | 180.0 | 180.0 | 18.0 |
| TLV70235DBVT | SOT-23 | DBV | 5 | 250 | 180.0 | 180.0 | 18.0 |
| TLV70236DSER | WSON | DSE | 6 | 3000 | 203.0 | 203.0 | 35.0 |
| TLV70236DSET | WSON | DSE | 6 | 250 | 203.0 | 203.0 | 35.0 |
| TLV70237DBVR | SOT-23 | DBV | 5 | 3000 | 180.0 | 180.0 | 18.0 |
| TLV70237DBVT | SOT-23 | DBV | 5 | 250 | 180.0 | 180.0 | 18.0 |
| TLV70237DSER | WSON | DSE | 6 | 3000 | 202.0 | 201.0 | 28.0 |
| TLV70237DSET | WSON | DSE | 6 | 250 | 202.0 | 201.0 | 28.0 |
| TLV70242PDSER | WSON | DSE | 6 | 3000 | 202.0 | 201.0 | 28.0 |
| TLV70242PDSET | WSON | DSE | 6 | 250 | 202.0 | 201.0 | 28.0 |
| TLV70245DBVR | SOT-23 | DBV | 5 | 3000 | 180.0 | 180.0 | 18.0 |
| TLV70245DBVT | SOT-23 | DBV | 5 | 250 | 180.0 | 180.0 | 18.0 |
| TLV702475DBVR | SOT-23 | DBV | 5 | 3000 | 180.0 | 180.0 | 18.0 |
| TLV702475DBVT | SOT-23 | DBV | 5 | 250 | 180.0 | 180.0 | 18.0 |

MECHANICAL DATA

DBV (R-PDSO-G5)

PLASTIC SMALL-OUTLINE PACKAGE

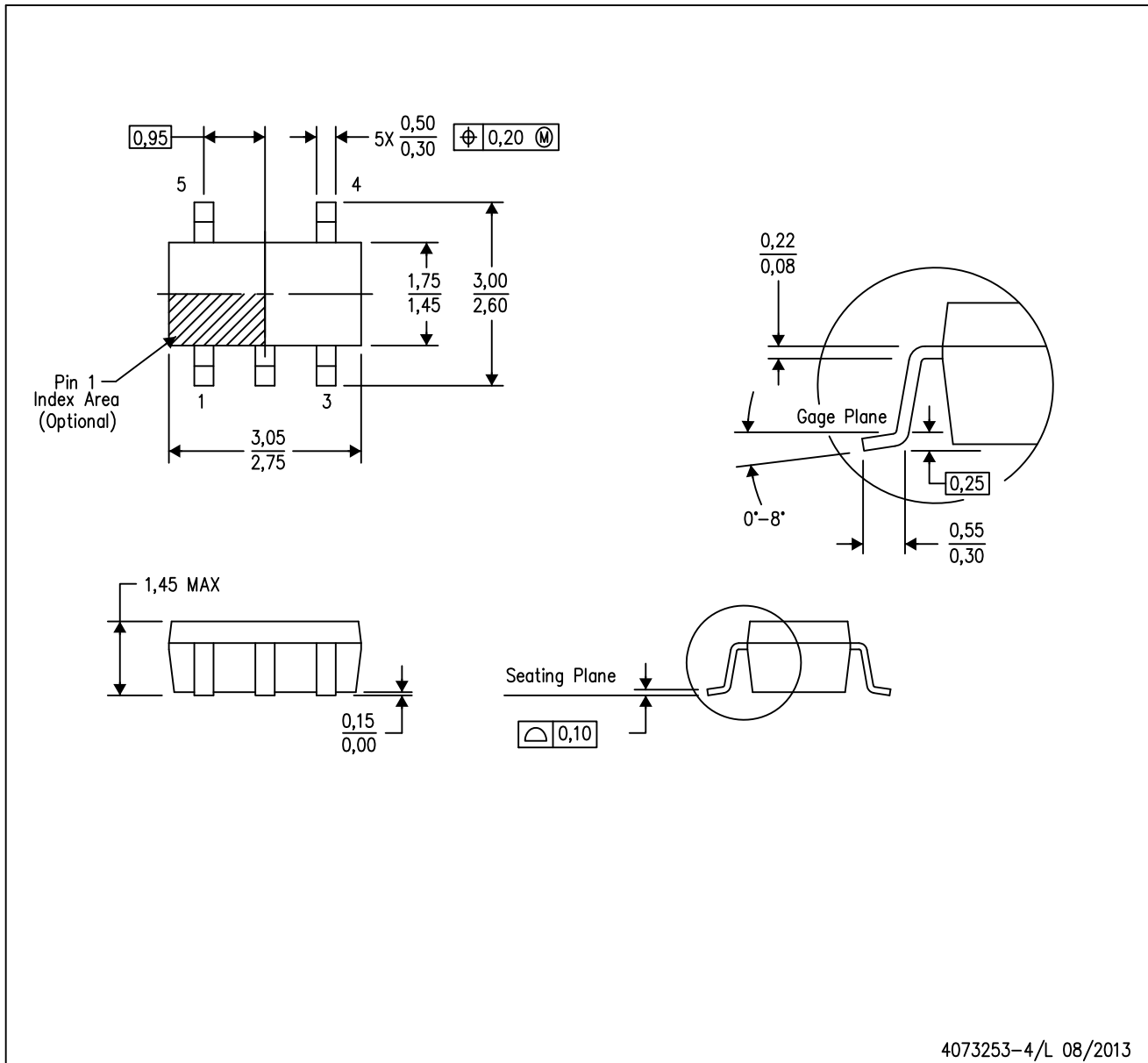

- NOTES:
- A. All linear dimensions are in millimeters.
 - B. This drawing is subject to change without notice.
 - C. Body dimensions do not include mold flash or protrusion. Mold flash and protrusion shall not exceed 0.15 per side.
 - D. Falls within JEDEC MO-178 Variation AA.

DBV (R-PDSO-G5)

PLASTIC SMALL OUTLINE



- NOTES:
- A. All linear dimensions are in millimeters.
 - B. This drawing is subject to change without notice.
 - C. Customers should place a note on the circuit board fabrication drawing not to alter the center solder mask defined pad.
 - D. Publication IPC-7351 is recommended for alternate designs.
 - E. Laser cutting apertures with trapezoidal walls and also rounding corners will offer better paste release. Customers should contact their board assembly site for stencil design recommendations. Example stencil design based on a 50% volumetric metal load solder paste. Refer to IPC-7525 for other stencil recommendations.

DSE (S-PDSO-N6)

PLASTIC SMALL OUTLINE

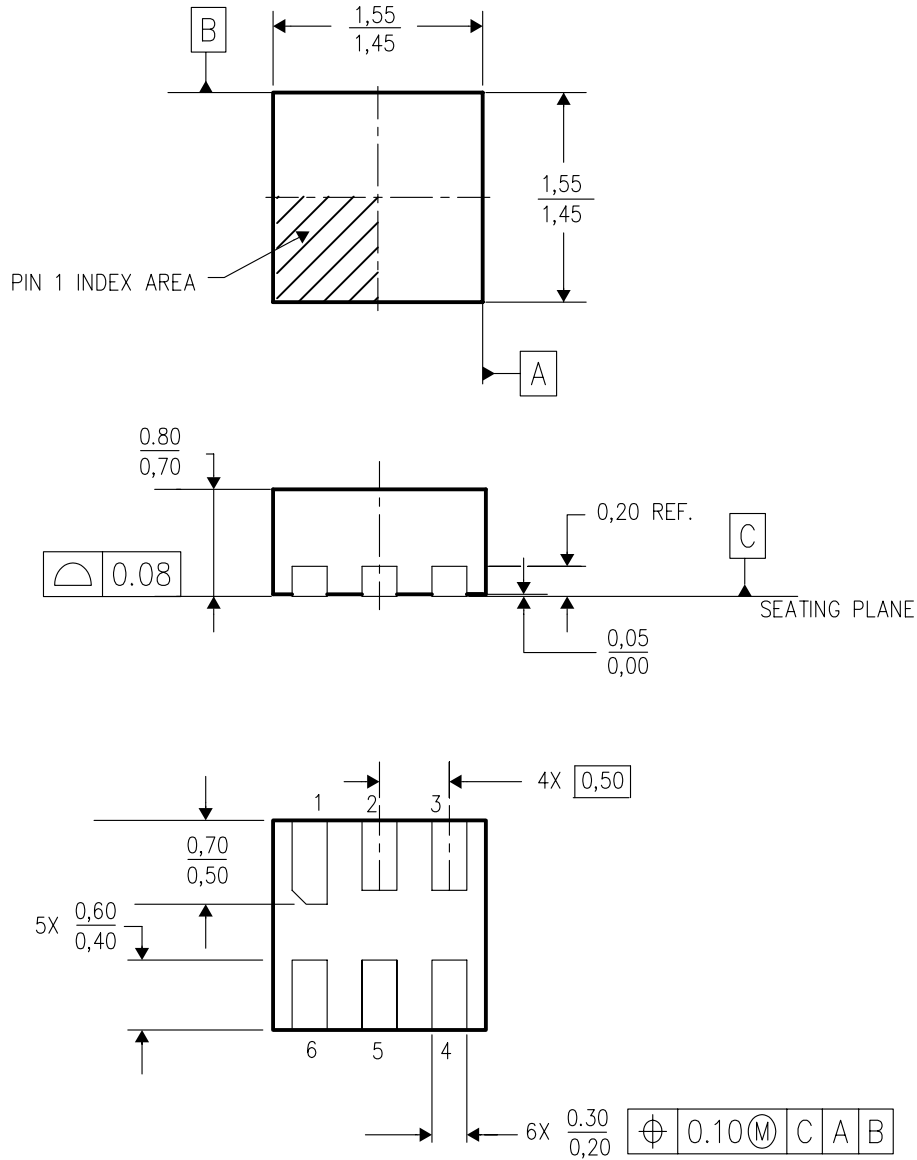

4207810/A 03/06

- NOTES:
- A. All linear dimensions are in millimeters.
 - B. This drawing is subject to change without notice.
 - C. Small Outline No-Lead (SON) package configuration.
 - D. This package is lead-free.

DSE (S-PWSON-N6)

PLASTIC SMALL OUTLINE NO-LEAD

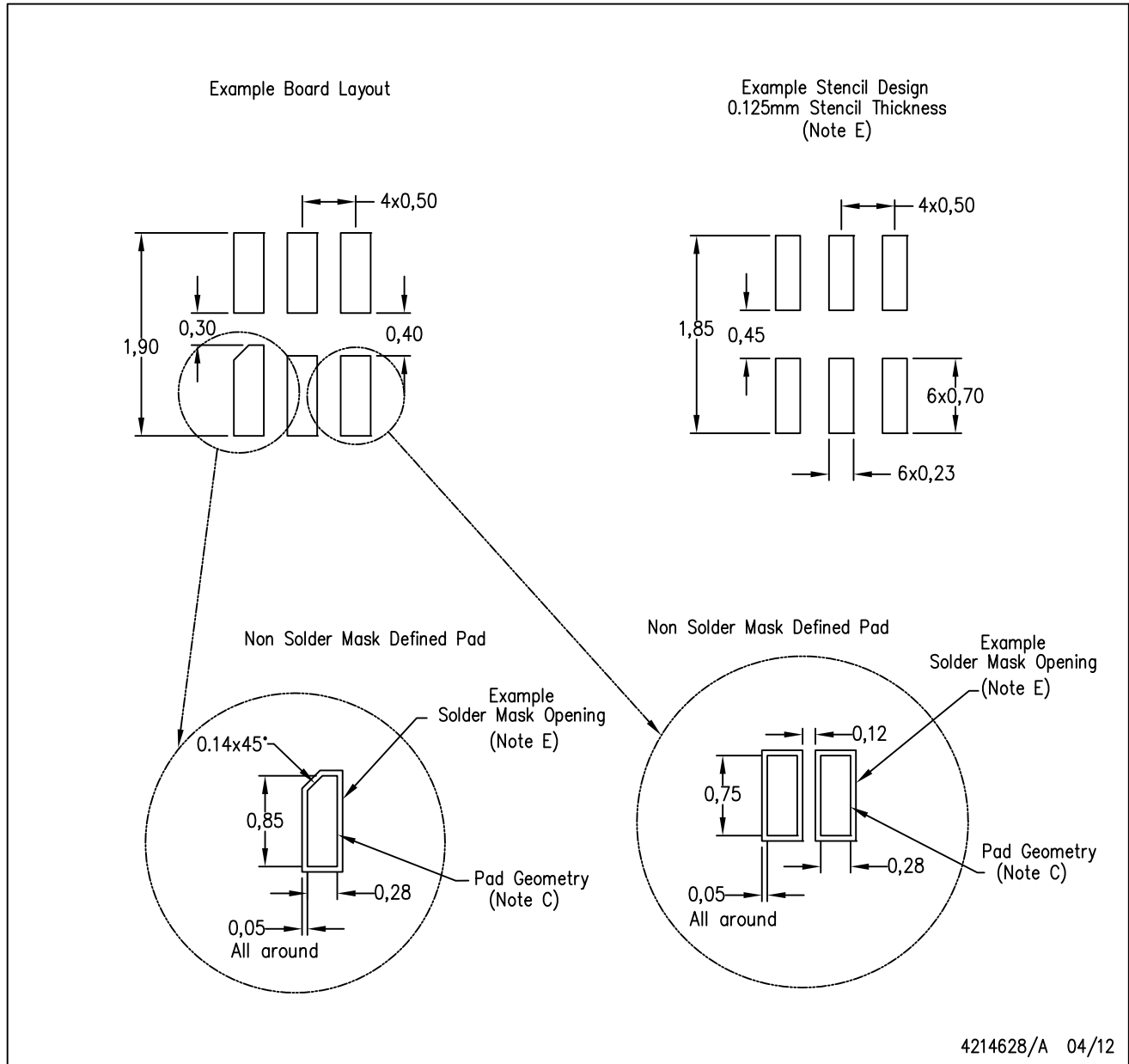

- NOTES:
- All linear dimensions are in millimeters.
 - This drawing is subject to change without notice.
 - Publication IPC-7351 is recommended for alternate designs.
 - Laser cutting apertures with trapezoidal walls and also rounding corners will offer better paste release. Customers should contact their board assembly site for stencil design recommendations. Refer to IPC 7525 for stencil design considerations.
 - Customers should contact their board fabrication site for solder mask tolerances.

IMPORTANT NOTICE

Texas Instruments Incorporated and its subsidiaries (TI) reserve the right to make corrections, enhancements, improvements and other changes to its semiconductor products and services per JESD46, latest issue, and to discontinue any product or service per JESD48, latest issue. Buyers should obtain the latest relevant information before placing orders and should verify that such information is current and complete. All semiconductor products (also referred to herein as "components") are sold subject to TI's terms and conditions of sale supplied at the time of order acknowledgment.

TI warrants performance of its components to the specifications applicable at the time of sale, in accordance with the warranty in TI's terms and conditions of sale of semiconductor products. Testing and other quality control techniques are used to the extent TI deems necessary to support this warranty. Except where mandated by applicable law, testing of all parameters of each component is not necessarily performed.

TI assumes no liability for applications assistance or the design of Buyers' products. Buyers are responsible for their products and applications using TI components. To minimize the risks associated with Buyers' products and applications, Buyers should provide adequate design and operating safeguards.

TI does not warrant or represent that any license, either express or implied, is granted under any patent right, copyright, mask work right, or other intellectual property right relating to any combination, machine, or process in which TI components or services are used. Information published by TI regarding third-party products or services does not constitute a license to use such products or services or a warranty or endorsement thereof. Use of such information may require a license from a third party under the patents or other intellectual property of the third party, or a license from TI under the patents or other intellectual property of TI.

Reproduction of significant portions of TI information in TI data books or data sheets is permissible only if reproduction is without alteration and is accompanied by all associated warranties, conditions, limitations, and notices. TI is not responsible or liable for such altered documentation. Information of third parties may be subject to additional restrictions.

Resale of TI components or services with statements different from or beyond the parameters stated by TI for that component or service voids all express and any implied warranties for the associated TI component or service and is an unfair and deceptive business practice. TI is not responsible or liable for any such statements.

Buyer acknowledges and agrees that it is solely responsible for compliance with all legal, regulatory and safety-related requirements concerning its products, and any use of TI components in its applications, notwithstanding any applications-related information or support that may be provided by TI. Buyer represents and agrees that it has all the necessary expertise to create and implement safeguards which anticipate dangerous consequences of failures, monitor failures and their consequences, lessen the likelihood of failures that might cause harm and take appropriate remedial actions. Buyer will fully indemnify TI and its representatives against any damages arising out of the use of any TI components in safety-critical applications.

In some cases, TI components may be promoted specifically to facilitate safety-related applications. With such components, TI's goal is to help enable customers to design and create their own end-product solutions that meet applicable functional safety standards and requirements. Nonetheless, such components are subject to these terms.

No TI components are authorized for use in FDA Class III (or similar life-critical medical equipment) unless authorized officers of the parties have executed a special agreement specifically governing such use.

Only those TI components which TI has specifically designated as military grade or "enhanced plastic" are designed and intended for use in military/aerospace applications or environments. Buyer acknowledges and agrees that any military or aerospace use of TI components which have **not** been so designated is solely at the Buyer's risk, and that Buyer is solely responsible for compliance with all legal and regulatory requirements in connection with such use.

TI has specifically designated certain components as meeting ISO/TS16949 requirements, mainly for automotive use. In any case of use of non-designated products, TI will not be responsible for any failure to meet ISO/TS16949.

Products

| | |
|------------------------------|--|
| Audio | www.ti.com/audio |
| Amplifiers | amplifier.ti.com |
| Data Converters | dataconverter.ti.com |
| DLP® Products | www.dlp.com |
| DSP | dsp.ti.com |
| Clocks and Timers | www.ti.com/clocks |
| Interface | interface.ti.com |
| Logic | logic.ti.com |
| Power Mgmt | power.ti.com |
| Microcontrollers | microcontroller.ti.com |
| RFID | www.ti-rfid.com |
| OMAP Applications Processors | www.ti.com/omap |
| Wireless Connectivity | www.ti.com/wirelessconnectivity |

Applications

| | |
|-------------------------------|--|
| Automotive and Transportation | www.ti.com/automotive |
| Communications and Telecom | www.ti.com/communications |
| Computers and Peripherals | www.ti.com/computers |
| Consumer Electronics | www.ti.com/consumer-apps |
| Energy and Lighting | www.ti.com/energy |
| Industrial | www.ti.com/industrial |
| Medical | www.ti.com/medical |
| Security | www.ti.com/security |
| Space, Avionics and Defense | www.ti.com/space-avionics-defense |
| Video and Imaging | www.ti.com/video |

TI E2E Community

e2e.ti.com