



CFM25S SERIES

25 WATT SINGLE OUTPUT AC-DC OPEN FRAME



Features

- * Universal Input 90~264VAC
- * High Efficiency up to 87%
- * Meets EN55032 Class B and CISPR/FCC Class B
- * Meets IEC/EN60335-1, IEC61558-1
- * Approved IEC/EN/UL62368-1
- * Continuous Short Circuit Protection
- * Over Voltage Protection
- * Peak Load (2 Times of Rated Current (**note7**))
- * No Load Input Power<0.1W
- * Class II



Ordering information

CFM25SXXX - X YZ (Optional)
 Blank: PCB mount Blank
 E: Encapsulated PL: Peak Load Function
 T: WAFER with Pin5 (BC+), Pin6(BC-)

MODEL	Output Voltage	Output Current	Ripple (mV p-p) NOTE 1	Voltage Accuracy NOTE2	Line Regulation NOTE3	Load Regulation NOTE4	% EFF. (typ.) NOTE5
CFM25S050	5V	4.0A	50mV	±2%	±1%	±1%	81%
CFM25S120	12V	2.1A	120mV	±1%	±1%	±1%	84%
CFM25S150	15V	1.67A	150mV	±1%	±1%	±1%	85%
CFM25S240	24V	1.05A	240mV	±1%	±1%	±1%	86%
CFM25S360	36V	0.7A	360mV	±1%	±1%	±1%	87%
CFM25S480	48V	0.52A	480mV	±1%	±1%	±1%	87%

Typical at 25°C, nominal line and 75% load, unless otherwise Specified

Specifications

INPUT SPECIFICATIONS:

Voltage 90~264Vac
 120~370Vdc
 Frequency 47 to 63Hz
 Inrush Current 60A max. @240Vac. Cold Start @25°C
 Leakage Current 0.25mA max. @ 264Vac
 Input Current 0.7A max.

OUTPUT SPECIFICATIONS:

Holdup Time 8ms typ. @115Vac
 Short Circuit Protection Hiccup Mode (Auto Recovery)
 Temperature Coefficient ±0.05%/°C max.
 Over Voltage Protection TVS Component to Clamp
 Over Current Protection .. 115%-200% Full Load and >10s (Auto Recovery)
 Startup time <3.0s

GENERAL SPECIFICATIONS:

Isolation Voltage (Input to Output) 3000VAC
 Operating Temperature -30°C~70°C (Derating from 50°C to 70°C)
 Storage Temperature -30°C~85°C
 Cooling Natural Convection
 Humidity 93%RH max. Non Condensing
 Switching Frequency 65KHz typical
 MTBF MIL-HDBK-217F, GB, 25°C/115VAC 500Khrs min.
 Life Time 26000 hours min.@ 75% Load, 40°C
 Altitude 5000m(UL60950-1), 3000m(IEC61558-1)
 Dimensions 2.000x1.100x0.980Inches(50.80x27.94x24.90mm)
 -E: 2.091x1.193x0.976Inches (53.10x30.30x24.80mm)
 -T: 2.776x1.100x0.906 Inches (70.50x27.94x23.00 mm)
 Weight 38g, 75g(-E), 40g(-T)

SAFETY AND EMISSION:

Emission and Immunity EN55032 Class B, FCC Part 15 Class B
 EN61000-6-3, EN61000-6-4, EN61000-3-2, EN6100-3-3
 Immunity EN55024, EN61204-3, EN61000-6-1, EN61000-6-2
 Safety IEC/EN/UL60950-1, IEC/EN/UL62368-1

Mechanical Specification

CFM25SXXX

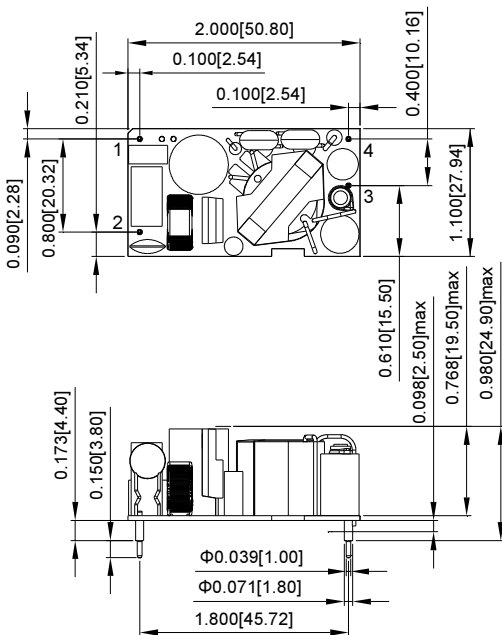

CFM25SXXX-E

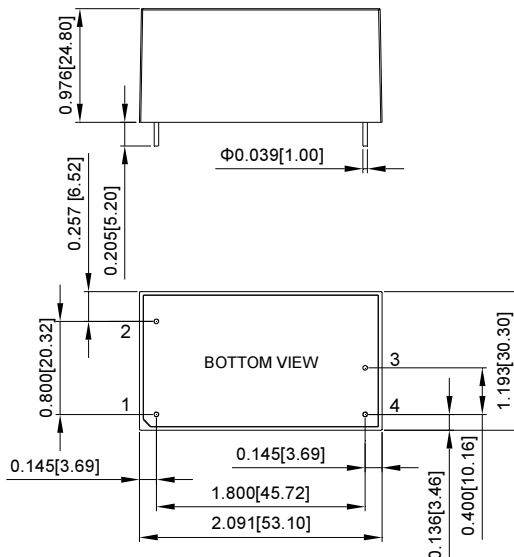

PIN CONNECTION

Pin	Function
1	ACL
2	ACN
3	+Vout
4	-Vout

All Dimensions are in inches[mm]
 Tolerance:Inches:X.XXX±0.02
 Millimeters:X.XX±0.5

CFM25S Series De-rating Curve

CFM25S050, CFM25S050-T

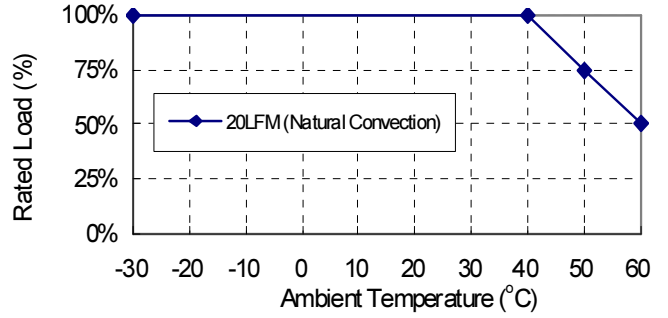

CFM25S120(-T), CFM25S150(-T), CFM25S240(-T)
 CFM25S360(-T), CFM25S480(-T), CFM25SXXX-E

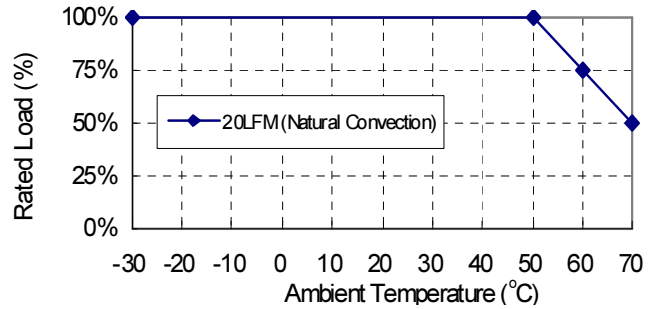

NOTE:

1. Add a 0.1uF ceramic capacitor and a 10uF E.L. capacitor to output for ripple & noise measuring @20MHz BW.
2. Voltage accuracy is set at 100% rated load and 25°C Ta.
3. Line regulation is measured from high line to low line with full load.
4. Load regulation is measured from 10% to 100% full load.
5. Typical efficiency at 230vac and full load at 25°C.
6. T Version wafer with JST B3B-XH / B4B-XH and mate with JST housing XH series or equivalent.
7. PL (peak load function) lasting time <10 seconds with a maximum 10% duty cycle and must add external 33uF/400V capacitor to BC+ & BC-

Mechanical Specification

CFM25SXXX PL

CFM25SXXX-E PL

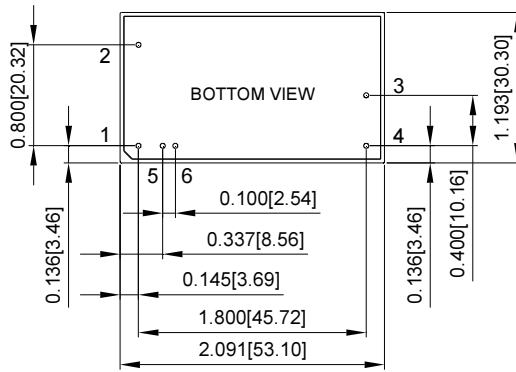
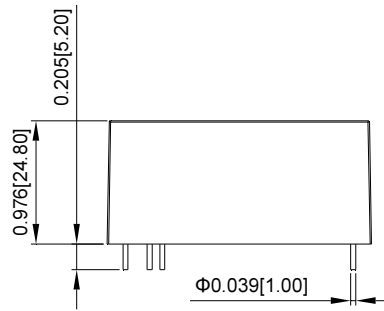
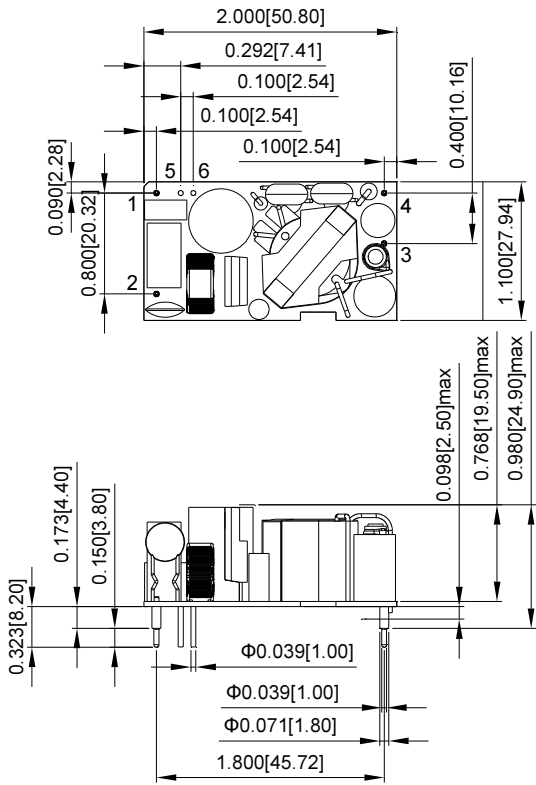

PIN CONNECTION

Pin	Function
1	ACL
2	ACN
3	+Vout
4	-Vout
5	BC+(Optional)
6	BC-(Optional)

CFM25SXXX-T

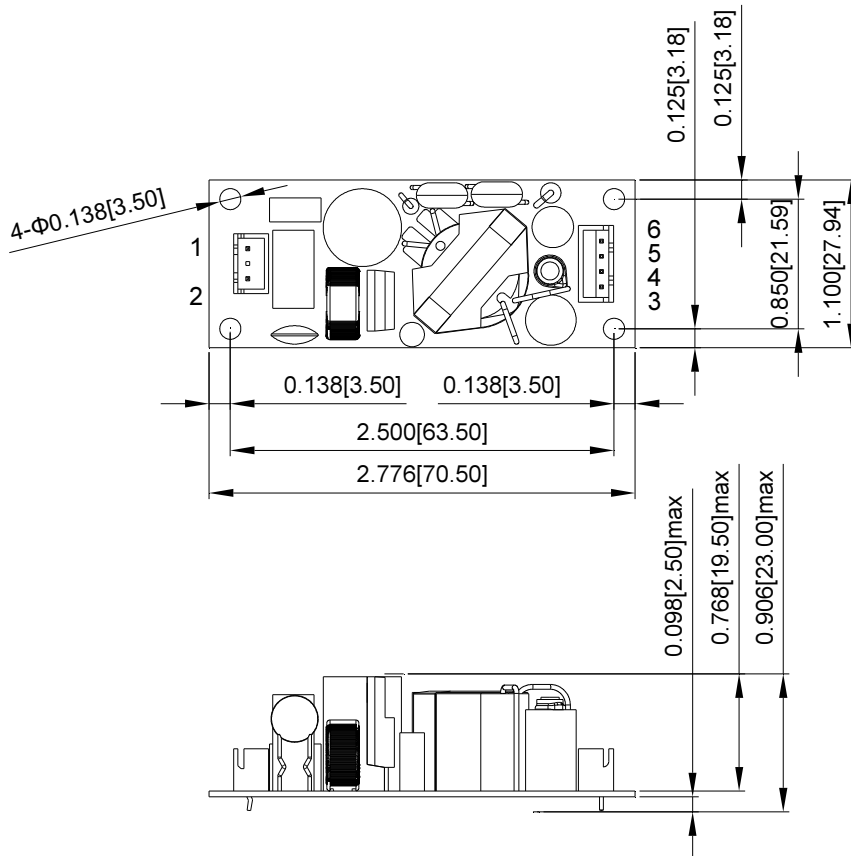

PIN CONNECTION

Pin	Function
1	ACL
2	ACN
3	+Vout
4	+Vout
5	-Vout
6	-Vout

Typical at 25°C, nominal line and 75% load, unless otherwise Specified