

80.11/21

80.41

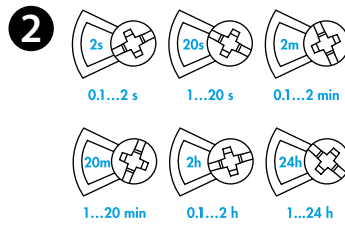

80.11.0.240.0000 80.21.0.240.0000 80.41.0.240.0000	
	U_N (24...240)V AC (50/60 Hz)/DC U_{min} 16.8 V AC/DC U_{max} 265 V AC/DC $P_{(AC/DC)} < 1.8$ VA (50 Hz) / < 1 W
	1 CO (SPDT) 16 A 250 V AC AC1 4000 VA AC15 (230 V AC) 750 VA (M) (230 V AC) 0.55 kW DC1 (30/110/220) V (16/0.3/0.12) A
	(-10...+50)°C
IP20	



LED	U_N		
	-	15 - 18	15 - 16
	✓	15 - 18	15 - 16
	✓		15 - 16
	✓	15 - 16	15 - 18

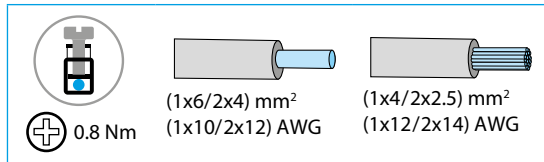
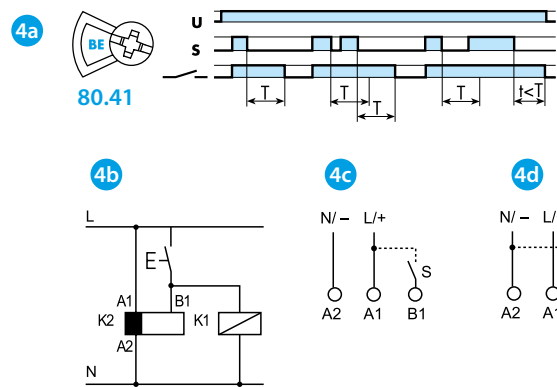
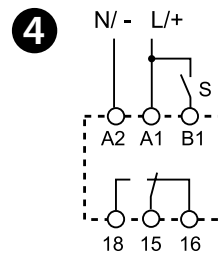
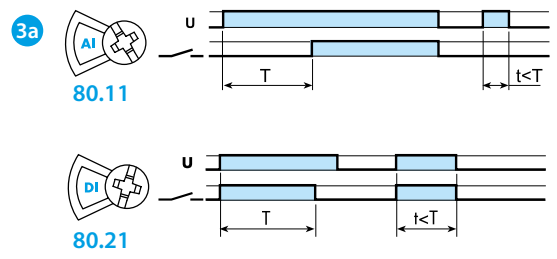
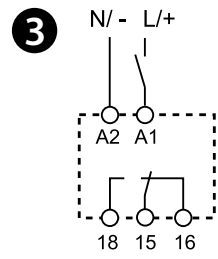
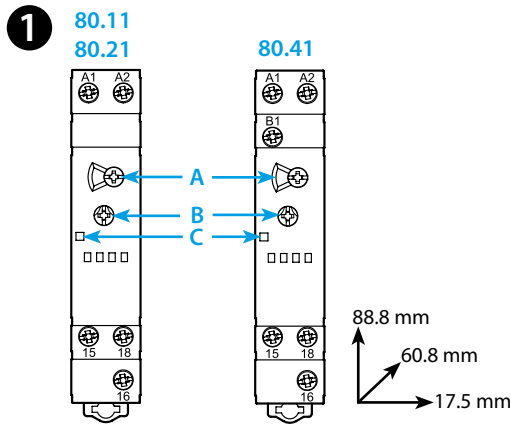

- Open Type Device
- Pollution degree 2 Installation Environment
- Maximum Surrounding Air Temperature 40°C
- Use 60/75°C copper (Cu) conductor only and wire ranges No. 14-18 AWG, stranded or solid
- Terminal tightening torque of 7.1 lb.in. (0.8 Nm)



ENGLISH

80.11 - 80.21 - 80.41
 MODULAR TIMER, MONO-FUNCTION

- 1 FRONT VIEW**
- A Time scales rotary selector
 - B Time setting
 - C LED
- 2 TIME SCALES**
- 3 WIRING DIAGRAM AND FUNCTIONS (80.11-80.21)**
- 3a Start via contact in supply line (A1)**
 80.11 AI = On-delay
 80.21 DI = Interval
- 4 WIRING DIAGRAM AND FUNCTION (80.41)**
- 4a With signal START function**
 Start via contact into control terminal (B1)
 BE = Off-delay with control signal
 - 4b** Possible to control an external load, such as another relay coil or timer, connected to the signal start terminal B1
 - 4c** With DC supply, positive polarity has to be connected to B1 terminal (according to EN 60204-1)
 - 4d** A voltage other than the supply voltage can be applied to the command Start (B1), example:
 A1-A2 = 230 V AC
 B1-A2 = 24 V DC

OTHER DATA

Minimum control impulse: 50 ms (80.41)
 Recovery time: 100 ms
 35 mm rail mount (EN 60715)

WORKING CONDITIONS

In conformity with the European Directive on EMC 2014/30/EC, the timer relay has a level of immunity, against radiated and conducted disturbances, considerably higher than requirements of EN 61812-1 standard.

However, devices like transformers, motors, contactors, switches and power cables may cause disturbances and even damage the timer electronic circuit. For that reason, the wiring cables must be as short as possible, and, when necessary, the timer shall be protected by the relevant RC network, varistor or surge voltage protector.

