



RAYSTAR

曜凌光電股份有限公司

住址: 42878 台中市大雅区科雅路 25 號 5F WEB: <http://www.Raystar-Optronics.com>
5F., No.25, Keya Rd., Daya Dist., Taichung E-mail: sales@raystar-optronics.com
City 428, Taiwan Tel:886-4-2565-0761 Fax : 886-4-2565-0760

RFG570F-ALW-DNS

SPECIFICATION

CUSTOMER:

APPROVED BY	
PCB VERSION	
DATE	

FOR CUSTOMER USE ONLY

SALES BY	APPROVED BY	CHECKED BY	PREPARED BY

Release DATE:

TFT Display Inspection Specification: <https://www.raystar-optronics.com/download/products.htm>

Precaution in use of TFT module: <https://www.raystar-optronics.com/download/declaration.htm>

Revision History

VERSION	DATE	REVISED PAGE NO.	Note
0	2013/04/26		First issue
A	2013/06/04		Correct Resolution
B	2013/07/08		Modify the packing diagram
C	2014/07/03		Update Rev.
D	2016/02/15		Add size & Surface, Resistance Touch Panel General Specification. Modify Block Diagram. Modify Reliability. Modify touchpanel.
E	2016/08/08		Remove Package Specification
F	2016/08/11		Modify Vibration test
G	2016/11/17		Modify Summary
H	2020/03/10		Modify LCD, Backlight and FPC. Modify LED driving conditions Add Uniformity.

Contents

1. Module Classification Information

2. Summary

3. General Specification

4. Interface

5. Contour Drawing

6. Block Diagram

7. Absolute Maximum Ratings

8. Electrical Characteristics

9. DC Characteristics

10. AC Characteristics

11. Optical Characteristics

12. Reliability

13. Touch Panel Information

14. Other

1. Module Classification Information

R	F	G	57	0F	-	A	L	W	-	D	N	S
1	2	3	4	5	-	6	7	8	-	9	10	11

Item	Description	
1	R : Raystar Optronics Inc.	
2	Display Type : F→TFT Type, J→ Custom TFT	
3	Solution: A: 128x160 B:320x234 C:320x240 D:480x234 E:480x272 F:800x480 G:640x480 H:1024x600 I:320x480 J:240x320 K:1280x800 L:240x400 M:1024x768 N:128x128 O:480x800 P:640x320 Q:800x600 S:480x128 T:800x320	
4	Display Size : 5.7" TFT	
5	Version Code.	
6	Model Type: A : TFT LCD E : TFT+FR+CONTROL BOARD J : TFT+FR+A/D BOARD N : TFT+FR+A/D BOARD+CONTROL BOARD S : TFT+FR+POWER BOARD (DC TO DC) 1 : TFT+CONTROL BOARD	6 : TFT+FR H : TFT+D/V BOARD I : TFT+FR+D/V BOARD B : TFT+POWER BD
7	Polarizer Type, Temperature range, View direction	I→Transmissive, W. T, 6:00 ; C→Transmissive, N. T, 6:00 L→Transmissive, W.T,12:00 ; F→Transmissive, N.T,12:00 Y→Transmissive,W.T, IPS TFT ; A→Transmissive, N.T, IPS TFT Z→Transmissive, W.T, O-TFT R→Transmissive, Super W.T, O-TFT N→Transmissive, Super W.T, 6:00; Q→Transmissive, Super W.T, 12:00 V→Transmissive, Super W.T, VA TFT
8	Backlight	W : LED, White H : LED, High Light White F : CCFL, White
9	Driver Method	D: Digital A: Analog L : LVDS M:MIPI
10	Interface	N : without control board A : 8Bit B : 16Bit S:SPI Interface R: RS232 U:USB I: I2C
11	TS	N : Without TS S : resistive touch panel C : capacitive touch panel capacitive touch panel (G-F-F) G : capacitive touch panel(G-G)

2.Summary

TFT 5.7” is a TN transmissive type color active matrix TFT liquid crystal display that use amorphous silicon TFT as switching devices. This module is a composed of a TFT_LCD module, It is usually designed for industrial application and this module follows RoHs,

RAYSTAR OPTRONICS

3.General Specifications

- Size: 5.7 inch
- Dot Matrix: 640 x RGBx480(TFT) dots
- Module dimension: 127.14 x 100.94 x 7.45 mm
- Active area: 115.2 x 86.4 mm
- Dot pitch: 0.06 x 0.18 mm
- LCD type: TFT, Normally White, Transmissive
- View Direction: 6 o'clock
- Gray Scale Inversion Direction: 12 o'clock
- Aspect Ratio: 4:3
- Backlight Type: LED ,Normally White
- With /Without TP: With RTP
- Surface: Anti-Glare

*Color tone slight changed by temperature and driving voltage.

4.Interface

4.1. LCM PIN Definition

Pin	Symbol	Function	Remark
1	DGND	Ground for digital circuit	
2	VCC	Power Supply : +3.3V	
3	VCC	Power Supply : +3.3V	
4	DGND	Ground for digital circuit	
5	VGL	Gate off power	
6	DGND	Ground for digital circuit	
7	VGH	Gate on power	
8	DGND	Ground for digital circuit	
9	UD	Up/down selection	
10	LR	Left /right selection	
11	SPENA	Chip select	
12	SPCK	Serial Clock	
13	SPDA	Serial Data	
14	NC	No connect	
15	DGND	Ground for digital circuit	
16	B5	Blue Data bus	
17	B4	Blue Data bus	
18	B3	Blue Data bus	
19	B2	Blue Data bus	
20	B1	Blue Data bus	
21	B0	Blue Data bus	
22	NC(TOP)	No connection	
23	NC(RIGHT)	No connection	
24	DGND	Ground for digital circuit	
25	G5	Green Data bit	
26	G4	Green Data bit	
27	G3	Green Data bit	
28	G2	Green Data bit	
29	G1	Green Data bit	
30	G0	Green Data bit	
31	NC(BOTTOM)	No connection	
32	NC(LEFT)	No connection	
33	AGND	Ground	

34	AVDD	Analog power: 10V	
35	AVDD	Analog power: 10V	
36	AGND	Ground	
37	R5	Red Data bit	
38	R4	Red Data bit	
39	R3	Red Data bit	
40	R2	Red Data bit	
41	R1	Red Data bit	
42	R0	Red Data bit	
43	DGND	Ground for digital circuit	
44	DGND	Ground for digital circuit	
45	DE	Data Enable input	
46	CLK	Data Clock	
47	HS	Horizontal sync input	
48	VS	Vertical sync input	
49	VCOM	VCOM driving input	
50	DGND	Ground for digital circuit	

4.2. Backlight PIN Definition

Pin No.	Symbol	Description
1	A	Red, LED_ Anode
2	K	Black, LED_ Cathode

5. Contour Drawing

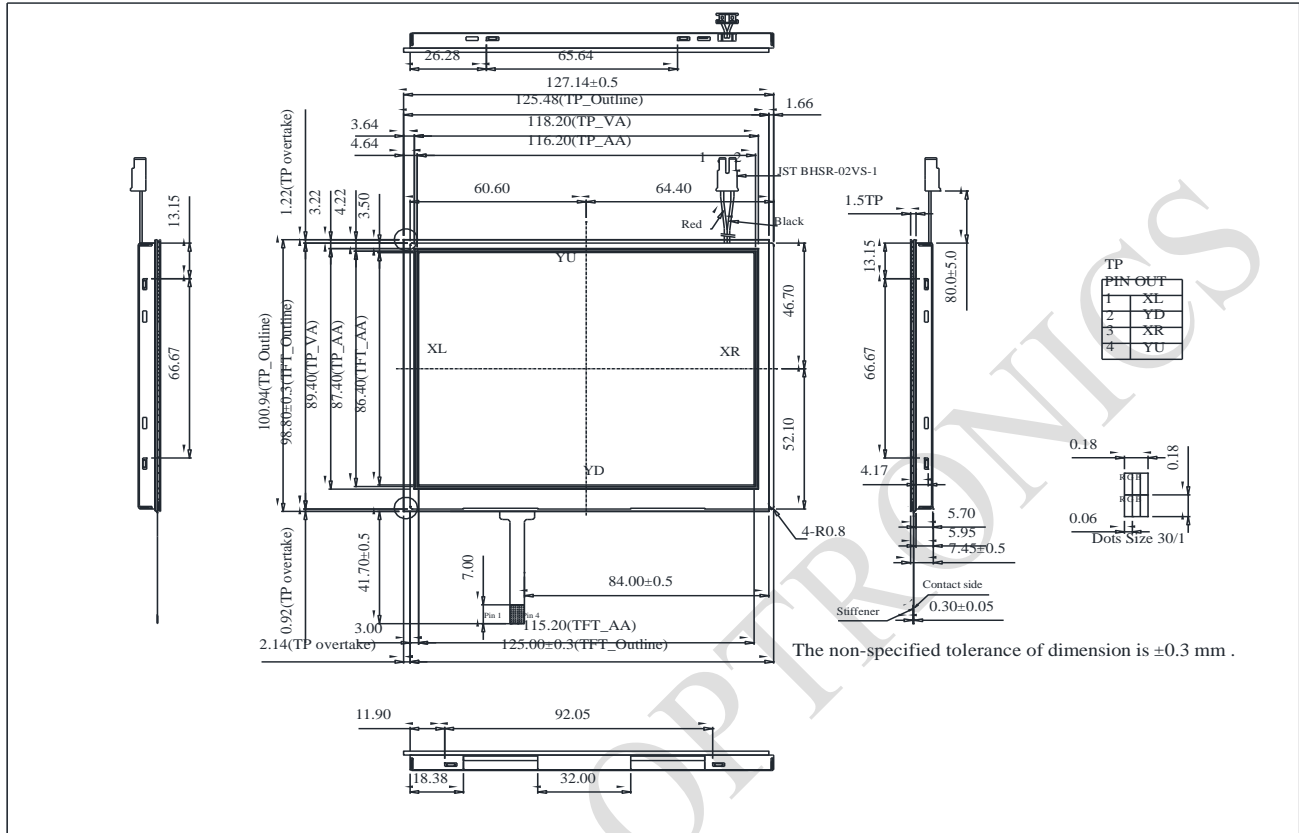

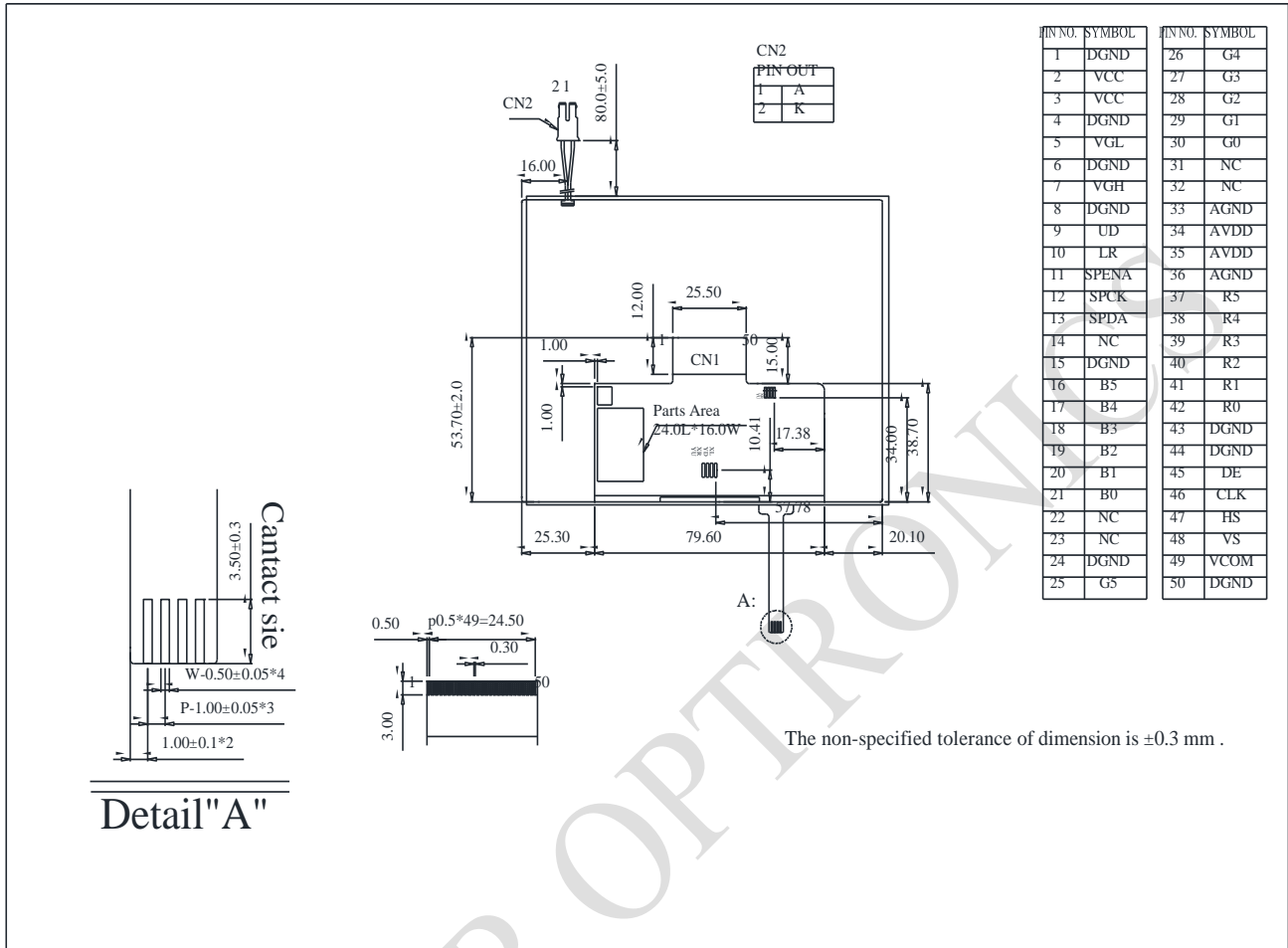

6. Block Diagram

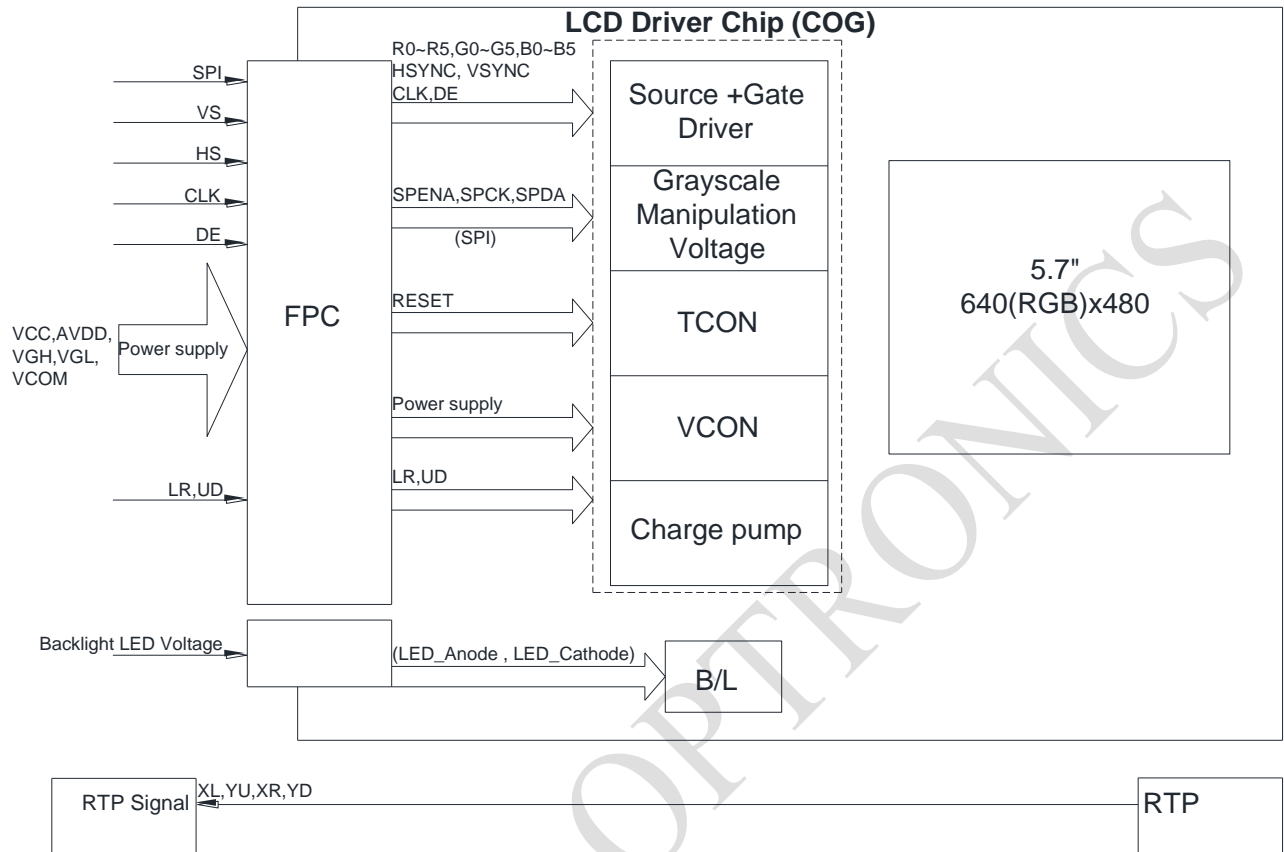

POWER SUPPLY

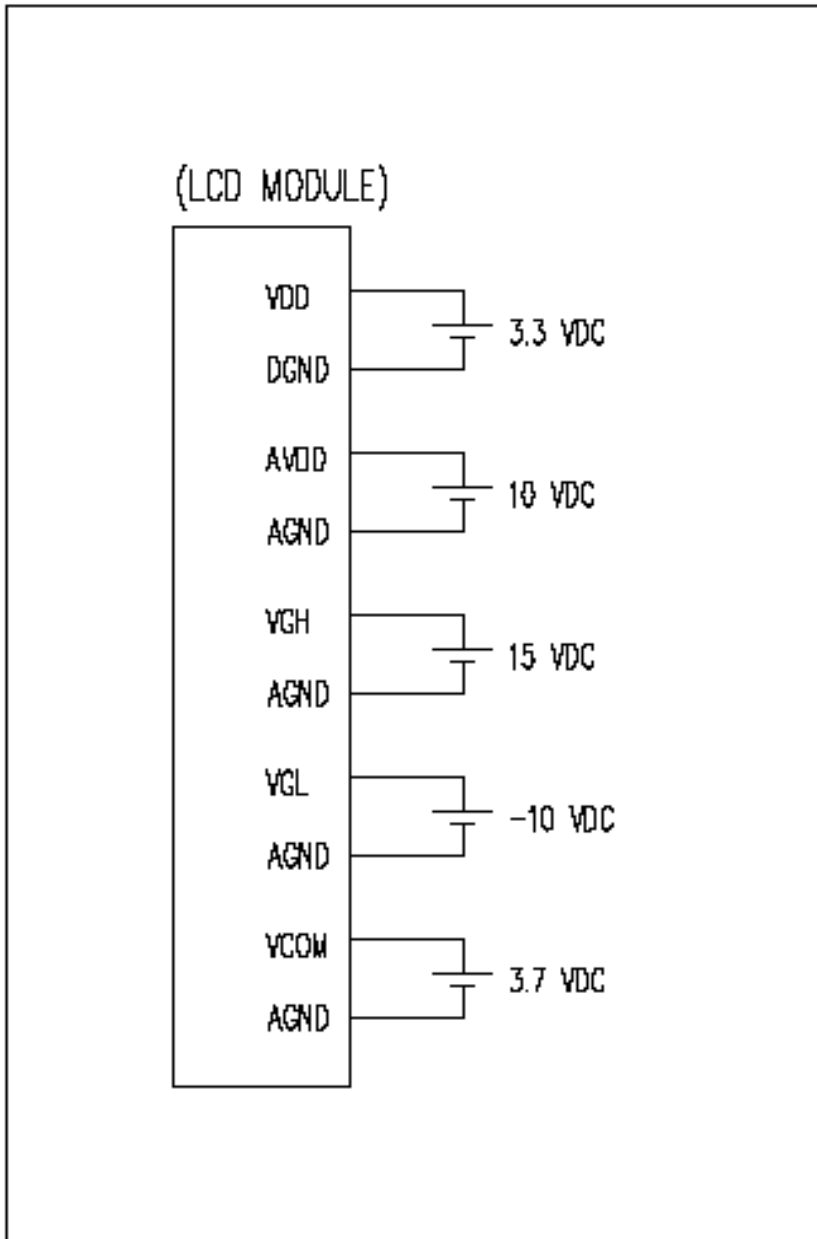

MICS

RA

7. Absolute Maximum Ratings

Item	Symbol	Min	Typ	Max	Unit
Operating Temperature	TOP	-20	—	+70	°C
Storage Temperature	TST	-30	—	+80	°C

Note: Device is subject to be damaged permanently if stresses beyond those absolute maximum ratings listed above

- Temp. $\leq 60^{\circ}\text{C}$, 90% RH MAX. Temp. $> 60^{\circ}\text{C}$, Absolute humidity shall be less than 90% RH at 60°C

RAYSTAR OPTRONICS

8. Electrical Characteristics

8.1. Operating conditions:

Item	Symbol	Condition	Min	Typ	Max	Unit
Supply Voltage For LCM	VCC	—	3.0	3.3	3.6	V
Supply Current For LCM	ICC	-	—	9	—	mA
Power Consumption	-	-	—	29.7	—	mW
Power Supply for Analog	AVDD	AVDD-AGND	10.5		11	V
Input Voltage	VIH	H Level	0.7VCC	—	VCC	V
	VIL	L Level	0	—	0.3VCC	V
Recommended LC Driving Voltage for 25°C	VGH	(Note)	13	16	17	V
	VGL		-8	-7	-6	V
	VCOM		3.97	4.02	4.07	V

Note 1 : This value is test for VDD=3.3V , Ta=25 °C only

- (1) VGH is TFT Gate on operating Voltage.
- (2) VGH is TFT Gate off operating Voltage ,VGL signal must be fluctuates with same phase as VCOM when Storage on Gate structure.
- (3) VCOM must be adjusted to optimize display quality Crosstalk , Contrast Ratio and etc

8.2. LED driving conditions

Parameter	Symbol	Min.	Typ.	Max.	Unit	Remark
LED current	-	-	60	-	mA	-
Power Consumption	-	-	1386	1479	mW	-
LED voltage	VBL+	18.9	23.1	24.5	V	Note 1
LED Life Time	-	-	50,000	-	Hr	Note 2,3,4

Note 1 : There are 1 Groups LED

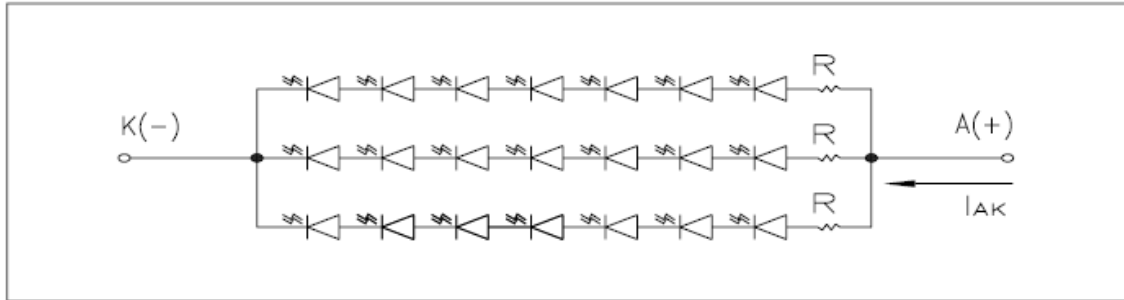

Note 2 : $T_a = 25\text{ }^\circ\text{C}$

Note 3 : Brightness to be decreased to 50% of the initial value

Note 4 : The single LED lamp case

9.DC CHARATERISTICS

Parameter	Symbol	Rating			Unit	Condition
		Min	Typ	Max		
Low level input voltage	V_{IL}	0	-	0.3VCC	V	
High level input voltage	V_{IH}	0.7VCC	-	VCC	V	

RAYSTAR OPTRONICS

10. Timing Characteristics

10.1. AC TIMING CHARACTERISTICS

Please refer to the IC SPEC :(Himax) HX8250-A01B
(Himax) HX8678-A000

10.2. POWER ON/OFF SEQUENCE

To prevent the device damage from latch up, the power ON/OFF sequence shown below must be followed.

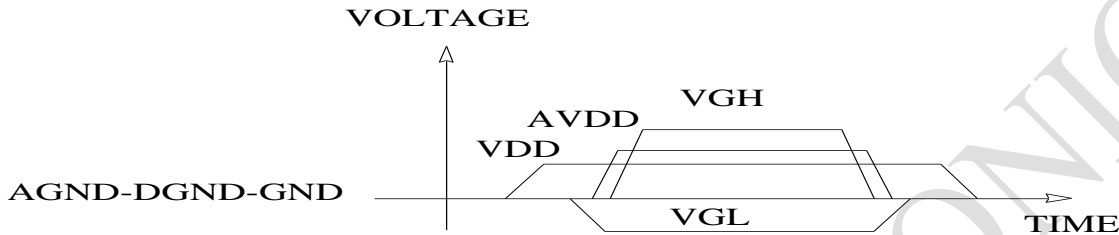

(NOET) DISPAY DIRECTION OF THE PANEL

The UD and LR control the Display direction of the panel .
The settings of UD and LR are or following:



(1) UD=VDD and LR=DGND



(2) UD=VDD and LR=VDD



(3) UD= DGND and LR=DGND



(4) UD= DGND and LR= VDD

11. Optical Characteristics

Item	Symbol	Condition.	Min	Typ.	Max.	Unit	Remark	
Response time	Tr+ Tf	$\theta=0^\circ$ 、 $\phi=0^\circ$	-	15	-	ms	Note 3,	
			-	35	-			
Contrast ratio	CR	At optimized viewing angle	150	250	-	-	Note 4,	
Color Chromaticity	White	$\theta=0^\circ$ 、 $\phi=0$	Wx	0.28	0.31	0.34	-	Note 2,6,7
			Wy	0.32	0.35	0.38	-	
Viewing angle (Gray Scale Inversion Direction)	Hor.	θ_R	-	60	-	Deg.	Note 1	
		θ_L	-	60	-			
	Ver.	ϕ_T	-	60	-			
		ϕ_B	-	40	-			
Brightness	-	-	250	350	-	cd/ m ²	Center of display	
Uniformity	(U)	-	70	-	-	%	Note5	

Ta=25±2°C, IL=60mA

Note 1: Definition of viewing angle range

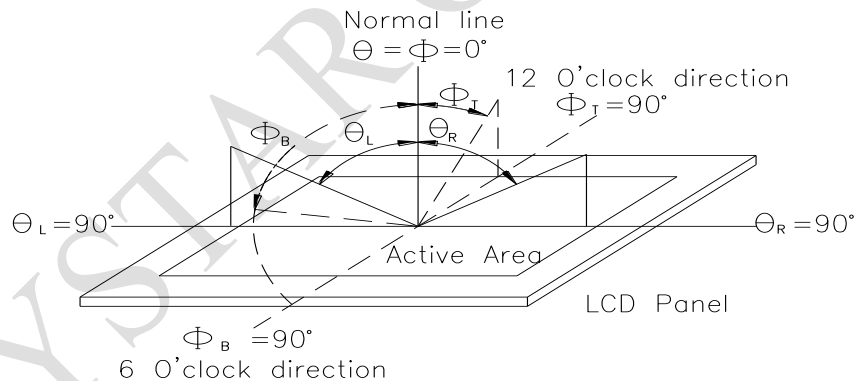

Fig.11.1. Definition of viewing angle

Note 2: Test equipment setup:

After stabilizing and leaving the panel alone at a driven temperature for 10 minutes, the measurement should be executed. Measurement should be executed in a stable, windless, and dark room. Optical specifications are measured by Topcon BM-7orBM-5 luminance meter 1.0° field of view at a distance of 50cm and normal direction.

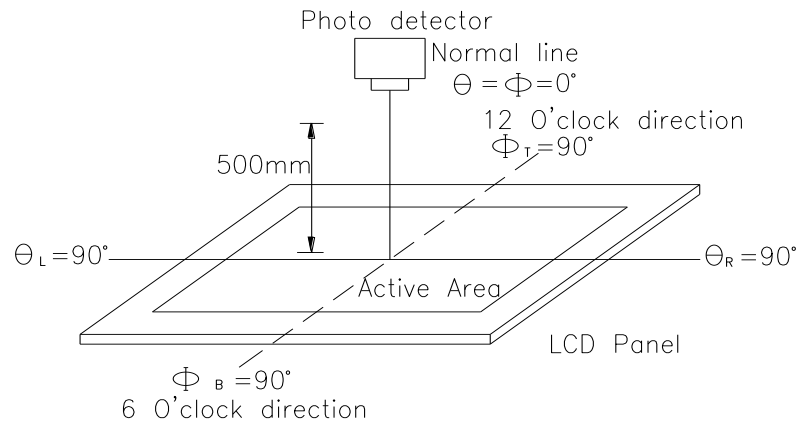
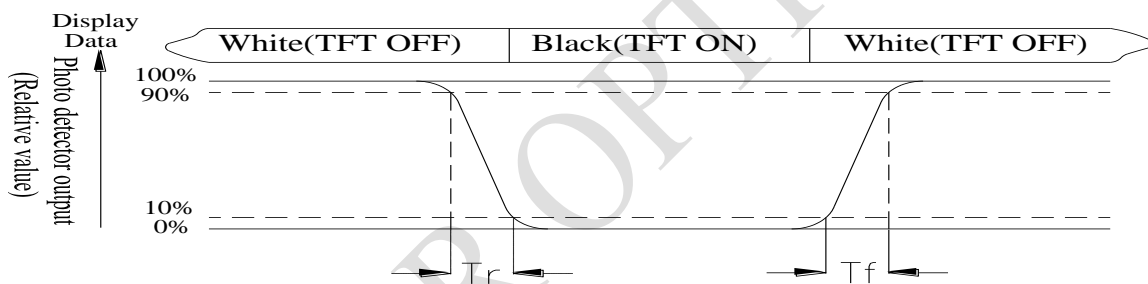

Fig. 11.2. Optical measurement system setup

Note 3: Definition of Response time:

The response time is defined as the LCD optical switching time interval between “White” state and “Black” state. Rise time, T_r , is the time between photo detector output intensity changed from 90% to 10%. And fall time, T_f , is the time between photo detector output intensity changed from 10% to 90%



Note 4: Definition of contrast ratio:

The contrast ratio is defined as the following expression.

$$\text{Contrast ratio (CR)} = \frac{\text{Luminance measured when LCD on the "White" state}}{\text{Luminance measured when LCD on the "Black" state}}$$

Note 5: Definition of Luminance Uniformity

Active area is divided into 9 measuring areas (reference the picture in below). Every measuring point is placed at the center of each measuring area.

Luminance Uniformity (U) = $L_{min}/L_{max} \times 100\%$

L = Active area length

W = Active area width

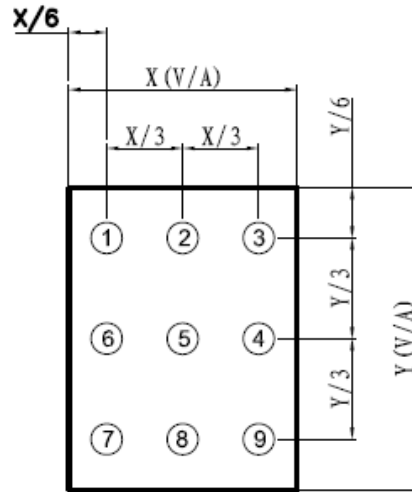

Fig11.3. . Definition of uniformity

Note 6: Definition of color chromaticity (CIE 1931)

Color coordinates measured at the center point of LCD

Note 7: Measured at the center area of the panel when all the input terminals of LCD panel are electrically opened.

12. Reliability

Content of Reliability Test (Wide temperature, -20°C~70°C)

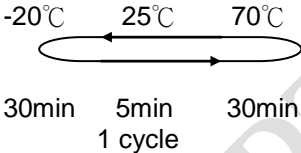
Environmental Test			
Test Item	Content of Test	Test Condition	Note
High Temperature storage	Endurance test applying the high storage temperature for a long time.	80°C 200hrs	2
Low Temperature storage	Endurance test applying the low storage temperature for a long time.	-30°C 200hrs	1,2
High Temperature Operation	Endurance test applying the electric stress (Voltage & Current) and the thermal stress to the element for a long time.	70°C 200hrs	—
Low Temperature Operation	Endurance test applying the electric stress under low temperature for a long time.	-20°C 200hrs	1
High Temperature/ Humidity Operation	The module should be allowed to stand at 60°C,90%RH max	60°C,90%RH 96hrs	1,2
Thermal shock resistance	The sample should be allowed stand the following 10 cycles of operation <div style="text-align: center;">  <p>-20°C 25°C 70°C</p> <p>30min 5min 30min</p> <p>1 cycle</p> </div>	-20°C/70°C 10 cycles	—
Vibration test	Endurance test applying the vibration during transportation and using.	Total fixed amplitude : 3 1.5mm Vibration Frequency : 10~55Hz One cycle 60 seconds to 3 directions of X,Y,Z for Each 15 minutes	3
Static electricity test	Endurance test applying the electric stress to the terminal.	VS=±600V(contact) ,±800v(air), RS=330Ω CS=150pF 10 times	—

Note1: No dew condensation to be observed.

Note2: The function test shall be conducted after 4 hours storage at the normal Temperature and humidity after remove from the test chamber.

Note3: The packing have to including into the vibration testing.

13.Touch Panel Information

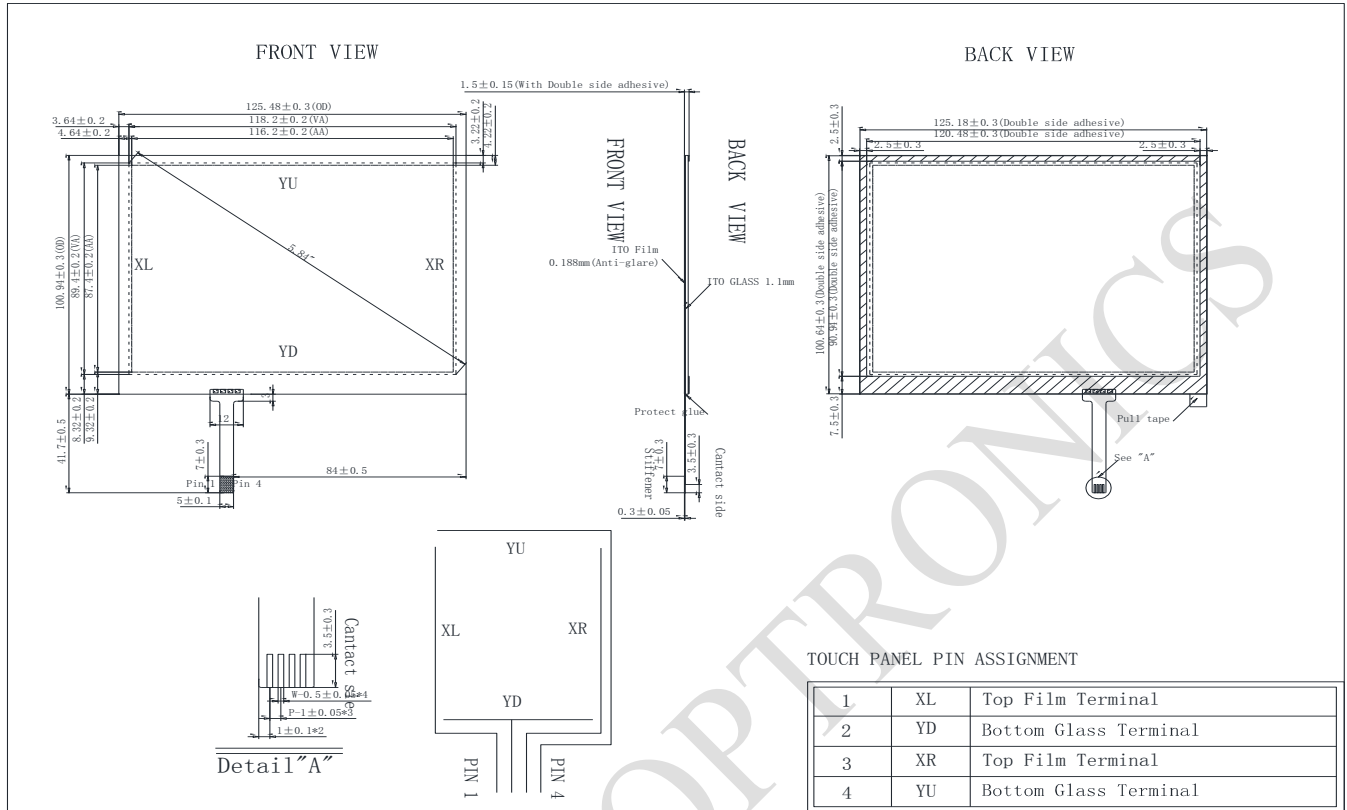

13.1. Resistance Touch Panel General Specifications

Item	Description
Driving condition	DC5V
Operating force	60~150g
Linearity max	$\leq \pm 1.5\%$
Insulating resistance	$> 20M\Omega \cdot 25V(DC)$
Light transparence	70%
Structure type	ITO Film/ITO Glass(F/G)
Surface Hardness	3H typ
Pen Hitting Durability (with the silicon rubber)	$> 1000,000$ times
X resistance	200~900 Ω
Y resistance	200~900 Ω

RAYSTAR OPTRONICS

LCM Sample Estimate Feedback Sheet

Module Number : _____

1 、 Panel Specification :

1. Panel Type :	<input type="checkbox"/> Pass	<input type="checkbox"/> NG , _____
2. View Direction :	<input type="checkbox"/> Pass	<input type="checkbox"/> NG , _____
3. Numbers of Dots :	<input type="checkbox"/> Pass	<input type="checkbox"/> NG , _____
4. View Area :	<input type="checkbox"/> Pass	<input type="checkbox"/> NG , _____
5. Active Area :	<input type="checkbox"/> Pass	<input type="checkbox"/> NG , _____
6. Operating Temperature :	<input type="checkbox"/> Pass	<input type="checkbox"/> NG , _____
7. Storage Temperature :	<input type="checkbox"/> Pass	<input type="checkbox"/> NG , _____
8. Others :	_____	

2 、 Mechanical Specification :

1. PCB Size :	<input type="checkbox"/> Pass	<input type="checkbox"/> NG , _____
2. Frame Size :	<input type="checkbox"/> Pass	<input type="checkbox"/> NG , _____
3. Material of Frame :	<input type="checkbox"/> Pass	<input type="checkbox"/> NG , _____
4. Connector Position :	<input type="checkbox"/> Pass	<input type="checkbox"/> NG , _____
5. Fix Hole Position :	<input type="checkbox"/> Pass	<input type="checkbox"/> NG , _____
6. Backlight Position :	<input type="checkbox"/> Pass	<input type="checkbox"/> NG , _____
7. Thickness of PCB :	<input type="checkbox"/> Pass	<input type="checkbox"/> NG , _____
8. Height of Frame to PCB :	<input type="checkbox"/> Pass	<input type="checkbox"/> NG , _____
9. Height of Module :	<input type="checkbox"/> Pass	<input type="checkbox"/> NG , _____
10. Others :	<input type="checkbox"/> Pass	<input type="checkbox"/> NG , _____

3 、 Relative Hole Size :

1. Pitch of Connector :	<input type="checkbox"/> Pass	<input type="checkbox"/> NG , _____
2. Hole size of Connector :	<input type="checkbox"/> Pass	<input type="checkbox"/> NG , _____
3. Mounting Hole size :	<input type="checkbox"/> Pass	<input type="checkbox"/> NG , _____
4. Mounting Hole Type :	<input type="checkbox"/> Pass	<input type="checkbox"/> NG , _____
5. Others :	<input type="checkbox"/> Pass	<input type="checkbox"/> NG , _____

4 、 Backlight Specification :

1. B/L Type :	<input type="checkbox"/> Pass	<input type="checkbox"/> NG , _____
2. B/L Color :	<input type="checkbox"/> Pass	<input type="checkbox"/> NG , _____
3. B/L Driving Voltage (Reference for LED Type) :	<input type="checkbox"/> Pass	<input type="checkbox"/> NG , _____
4. B/L Driving Current :	<input type="checkbox"/> Pass	<input type="checkbox"/> NG , _____
5. Brightness of B/L :	<input type="checkbox"/> Pass	<input type="checkbox"/> NG , _____
6. B/L Solder Method :	<input type="checkbox"/> Pass	<input type="checkbox"/> NG , _____
7. Others :	<input type="checkbox"/> Pass	<input type="checkbox"/> NG , _____

>> **Go to page 2** <<

Module Number : _____		
5 · <u>Electronic Characteristics of Module</u> :		
1.Input Voltage :	<input type="checkbox"/> Pass	<input type="checkbox"/> NG , _____
2.Supply Current :	<input type="checkbox"/> Pass	<input type="checkbox"/> NG , _____
3.Driving Voltage for LCD :	<input type="checkbox"/> Pass	<input type="checkbox"/> NG , _____
4.Contrast for LCD :	<input type="checkbox"/> Pass	<input type="checkbox"/> NG , _____
5.B/L Driving Method :	<input type="checkbox"/> Pass	<input type="checkbox"/> NG , _____
6.Negative Voltage Output :	<input type="checkbox"/> Pass	<input type="checkbox"/> NG , _____
7.Interface Function :	<input type="checkbox"/> Pass	<input type="checkbox"/> NG , _____
8.LCD Uniformity :	<input type="checkbox"/> Pass	<input type="checkbox"/> NG , _____
9.ESD test :	<input type="checkbox"/> Pass	<input type="checkbox"/> NG , _____
10.Others :	<input type="checkbox"/> Pass	<input type="checkbox"/> NG , _____
6 · <u>Summary</u> :		
<p style="text-align: right; margin-right: 50px;">Sales signature : _____</p> <p style="text-align: right; margin-right: 100px;">Customer Signature : _____</p> <p style="text-align: right; margin-right: 100px;">Date : / / _____</p>		