

300mW, NPN Small Signal Transistor

FEATURES

- Low power loss, high efficiency
- Ideal for automated placement
- High surge current capability
- Moisture sensitivity level: level 1, per J-STD-020
- RoHS Compliant
- Halogen-free according to IEC 61249-2-21

APPLICATIONS

- Switching mode power supply (SMPS)
- Adapters
- Lighting application
- On-board DC/DC converter

MECHANICAL DATA

- Case: SOT-23
- Molding compound: UL flammability classification rating 94V-0
- Matte tin plated leads, solderable per J-STD-002
- Meet JESD 201 class 1A whisker test
- Polarity: Indicated by cathode band
- Weight: 8 mg (approximately)

KEY PARAMETERS		
PARAMETER	VALUE	UNIT
V_{CBO}	75	V
V_{CEO}	40	V
V_{EBO}	6	V
I_C	600	mA
h_{FE}	300	
Package	SOT-23	
Configuration	Single die	

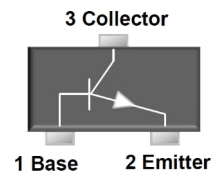

ABSOLUTE MAXIMUM RATINGS ($T_A = 25^\circ\text{C}$ unless otherwise noted)			
PARAMETER	SYMBOL	MMBT2222A	UNIT
Marking code on the device		1P	
Collector-base voltage, emitter open	V_{CBO}	75	V
Collector-emitter voltage, base open	V_{CEO}	40	V
Emitter-base voltage, collector open	V_{EBO}	6	V
Collector current, dc	I_C	600	mA
Total dc power input to all terminals	P_T	300	mW
Junction temperature	T_J	-55 to +150	$^\circ\text{C}$
Storage temperature	T_{STG}	-55 to +150	$^\circ\text{C}$

ELECTRICAL SPECIFICATIONS ($T_A = 25^\circ\text{C}$ unless otherwise noted)						
PARAMETER	CONDITIONS	SYMBOL	MIN	TYP	MAX	UNIT
Collector-base breakdown voltage, emitter open	$I_C = 10\ \mu\text{A}, I_E = 0$	$V_{(BR)CBO}$	75	-	-	V
Collector-emitter breakdown voltage, base open	$I_C = 10\ \text{mA}, I_B = 0$	$V_{(BR)CEO}$	40	-	-	V
Emitter-base breakdown voltage, collector open	$I_E = 10\ \mu\text{A}, I_C = 0$	$V_{(BR)EBO}$	6	-	-	V
Collector cutoff current, emitter open	$V_{CB} = 60\ \text{V}, I_E = 0$	I_{CBO}	-	-	0.01	μA
Emitter cutoff current, collector open	$V_{EB} = 3\ \text{V}, I_C = 0$	I_{EBO}	-	-	0.1	μA
DC Current Gain	$V_{CE} = 10\ \text{V}, I_C = 500\ \text{mA}$	h_{FE}	40	-	-	
	$V_{CE} = 10\ \text{V}, I_C = 150\ \text{mA}$		100	-	300	
	$V_{CE} = 10\ \text{V}, I_C = 10\ \text{mA}$		75	-	-	
	$V_{CE} = 10\ \text{V}, I_C = 1\ \text{mA}$		50	-	-	
	$V_{CE} = 10\ \text{V}, I_C = 0.1\ \text{mA}$		35	-	-	
Collector-emitter saturation voltage	$I_C = 500\ \text{mA}, I_B = 50\ \text{mA}$	$V_{CE(sat)}$	-	-	1	V
Base-emitter saturation voltage	$I_C = 500\ \text{mA}, I_B = 50\ \text{mA}$	$V_{BE(sat)}$	-	-	2	V
Transition frequency	$V_{CE} = 20\ \text{V}, I_C = 20\ \text{mA}, f = 100\ \text{MHz}$	f_T	300	-	-	MHz
Output Capacitance	1 MHz, $V_{CB} = 10\ \text{V}, I_E = 0$	C_{OBO}	8			pF
Input Capacitance	1 MHz, $V_{EB} = 0.5\ \text{V}, I_C = 0$	C_{IBO}	25			pF
Delay Time	$V_{CC} = 30\ \text{V}, V_{BE(off)} = -0.5\ \text{V}, I_C = 150\ \text{mA}$	t_d	-	-	10	ns
Rise Time	$I_{B1} = 15\ \text{mA}$	t_r	-	-	25	ns
Storage Time	$V_{CC} = 30\ \text{V}, I_{B1} = -I_{B2} = 15\ \text{mA}, I_C = 150\ \text{mA}$	t_s	-	-	225	ns
Fall Time	$V_{CC} = 30\ \text{V}, I_{B1} = -I_{B2} = 15\ \text{mA}, I_C = 150\ \text{mA}$	t_f	-	-	60	ns

ORDERING INFORMATION		
ORDERING CODE	PACKAGE	PACKING
MMBT2222A RFG	SOT-23	3K / 7" Reel

CHARACTERISTICS CURVES

($T_A = 25^\circ\text{C}$ unless otherwise noted)

Fig. 1 Max Power Dissipation VS. Ambient Temperature

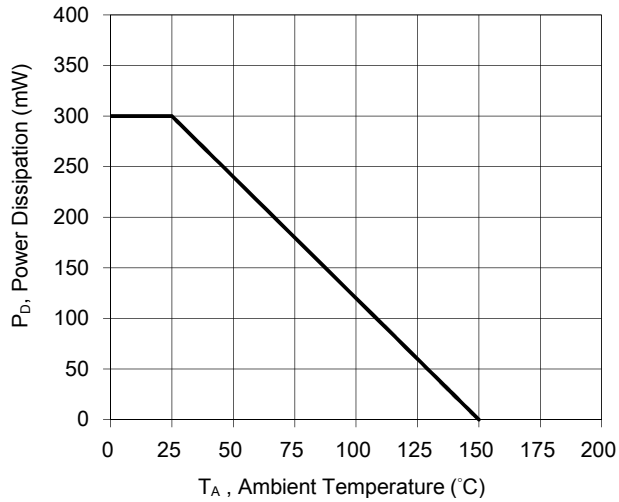

Fig.2 Typical Capacitance

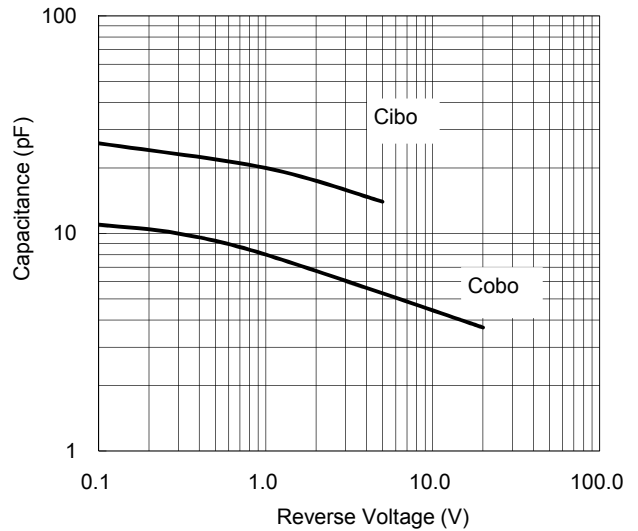

Fig.3 Typical DC Current Gain VS. Collector Current

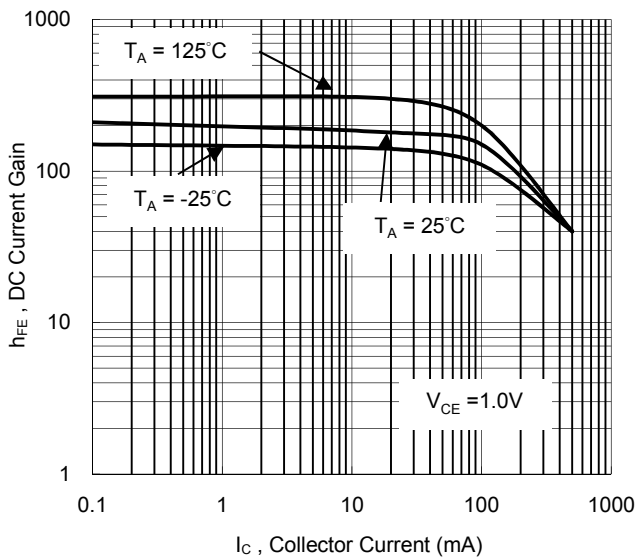
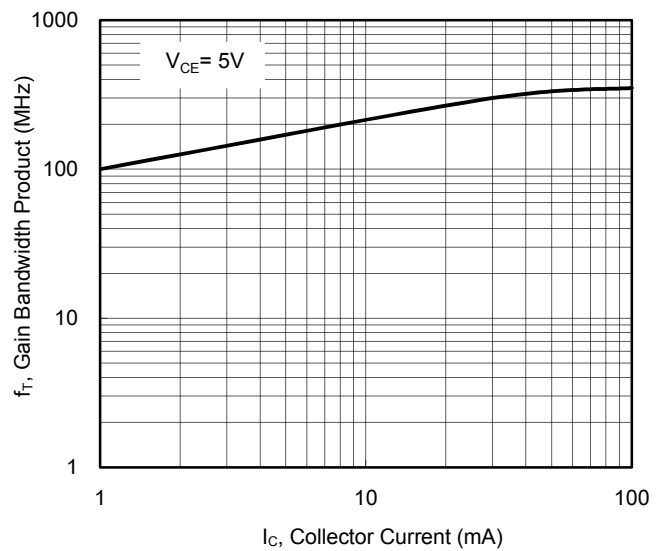

Fig.4 Gain Bandwidth Product VS. Collector Current



CHARACTERISTICS CURVES

($T_A = 25^\circ\text{C}$ unless otherwise noted)

Fig.5 Collector Emitter Saturation Voltage VS. Collector Current

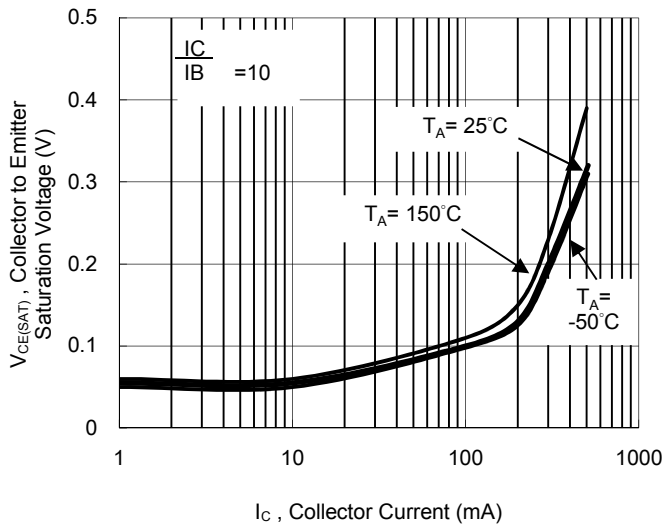
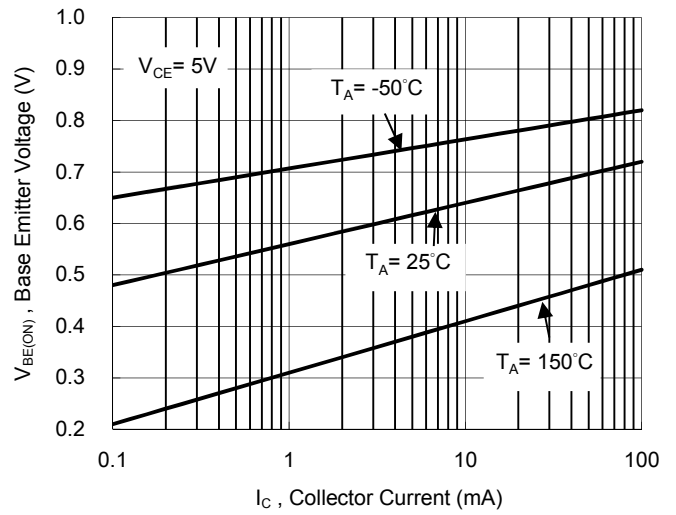
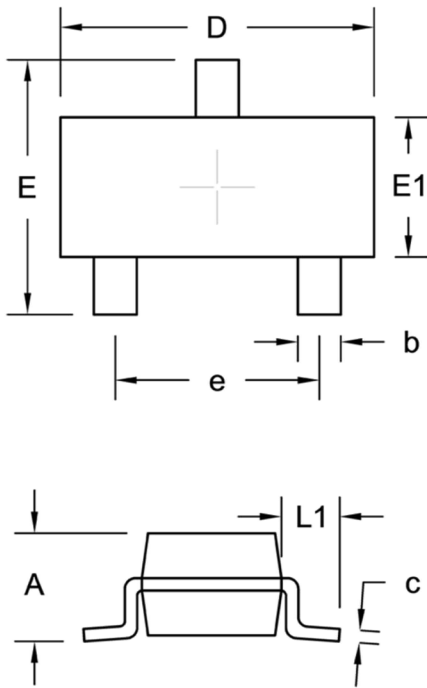

Fig.6 Base Emitter Voltage vs. Collector Current



PACKAGE OUTLINE DIMENSION

SOT-23



DIM.	Unit (mm)		Unit (inch)	
	Min.	Max.	Min.	Max.
A	0.89	1.12	0.035	0.044
b	0.30	0.50	0.012	0.020
c	0.08	0.20	0.003	0.008
D	2.80	3.04	0.110	0.120
E	2.10	2.64	0.083	0.104
E1	1.20	1.40	0.047	0.055
e	1.90 BSC		0.075 BSC	
L1	0.54 REF.		0.021 REF.	

SUGGESTED PAD LAYOUT

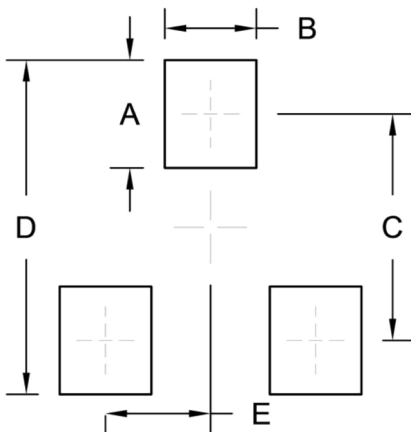

Symbol	Unit (mm)	Unit (inch)
A	1.00	0.039
B	0.85	0.033
C	2.10	0.083
D	3.10	0.122
E	0.98	0.039

Notice

Specifications of the products displayed herein are subject to change without notice. TSC or anyone on its behalf, assumes no responsibility or liability for any errors or inaccuracies.

Purchasers are solely responsible for the choice, selection, and use of TSC products and TSC assumes no liability for application assistance or the design of Purchasers' products.

Information contained herein is intended to provide a product description only. No license, express or implied, to any intellectual property rights is granted by this document. Except as provided in TSC's terms and conditions of sale for such products, TSC assumes no liability whatsoever, and disclaims any express or implied warranty, relating to sale and/or use of TSC products including liability or warranties relating to fitness for a particular purpose, merchantability, or infringement of any patent, copyright, or other intellectual property right.

The products shown herein are not designed for use in medical, life-saving, or life-sustaining applications. Customers using or selling these products for use in such applications do so at their own risk and agree to fully indemnify TSC for any damages resulting from such improper use or sale.