

億力光電股份有限公司

EVERVISION ELECTRONICS CO., LTD.

Product Specification For LCD Module

(KVPF-7B-002-16)

Model NO. : VGG644810-6UFLWB(RoHS)

REVISION : 2

APPROVAL FOR SPECIFICATIONS ONLY

APPROVAL FOR SPECIFICATIONS AND SAMPLE

CUSTOMER :

STD.

APPROVED BY :

EVERVISION LCM R&D CENTER

APPROVED BY

CHECKED BY

PREPARED BY

張乃元
3/21/16

張乃元
3/21/16

余宗耀
3/21/16

余宗耀
3/21/16

DIRECTOR

MANAGER

Mechanism Engineer

Electronic Engineer

億力光電股份有限公司總公司
EVERVISION ELECTRONICS CO., LTD.
台北市中和區建一路 186 號 6 樓之 5
6F.-5, No.186, Jian 1st Rd., Zhonghe Dist.,
New Taipei City 235, Taiwan (R.O.C.)
TEL : +886 2 8227-2788
FAX : +886 2 8227-2799

億力光電股份有限公司台中分公司
EVERVISION ELECTRONICS CO., LTD.
-Taichung Branch
台中市潭子區建國路 19 號
No.19, Jianguo Rd., Tanzi Dist.,
Taichung City 427, Taiwan (R.O.C.)
TEL : +886 4 2532-8889
FAX : +886 4 2532-6689

勁佳光電(昆山)有限公司
VBEST ELECTRONICS(KUNSHAN) Co., Ltd.
江蘇省昆山市玉山鎮高科技工業園城北路 8 號
No.8, Chengbei Rd., Hi-Tech Industry Park,
Yushan Town, Kunshan City, Jiangsu, China.
TEL : +86 512 5778 7288
FAX : +86 512 5777 0688

勁佳光電(昆山)有限公司東莞分公司
VBEST ELECTRONICS(KUNSHAN)Co.,Ltd.
- DongGuan Branch
東莞市莞城區東縱大道天寶路 23 號
No.23 Tian Bao Rd., Dong Zong St.,
Dong Guan City, Guang Dong, China.
TEL : +86 769 3887 5000
FAX : +86 769 3896 0580

<http://www.evervisionlcd.com>

EVERVISION	MODEL NO.		PAGE
	VGG644810-6UFLWB	SPEC SAMPLE	2

1. Table of Contents

No.	Contents	Page
1	Table of Contents	2
2	Record of Revisions	3
3	Module Numbering System	4
4	Application	5
5	Features	5
6	General Specifications	5
7	Absolute Maximum Ratings	6
8	Electrical Characteristics	7
9	Block Diagram	9
10	Input / Output Terminals Pin Assignment	10
11	Interface Timing	15
12	Optical Characteristics	25
13	Reliability Test	28
14	Packaging	29
15	Precautions	30
16	Outline Drawing	32
17	Definition of Labels	33
18	Incoming Inspection Standards	35

EVERVISION	MODEL NO.		PAGE
	VGG644810-6UFLWB	SPEC SAMPLE	4

3. Module Numbering System

V G G 6448 10 – 6 U F L W B

Serial No.:A~Z

Backlight Color:

N:Without Backlight;
A:Amber; **B:**Blue; **G:**Green;
L:Yellow; **O:**Orange; **R:**Red;
W:White; **Y:**YellowGreen;
X:Others

Backlight Type:

N:Without Backlight; **E:**EL; **F:**CCFL;
L:General LED; **H:**High NTSC LED ;
R:RGB LED; **X:**Others

LCD Model:

A:ASTN; **B:**STN Blue; **C:**CSTN; **D:**DSTN;
F:TFT; **G:**STN Gray; **H:**HTN; **I:**IBN;
K:Black Mask TN **L:**LTPS; **M:**MVA;
N:others; **O:**OLED; **P:**PLED; **S:**IPS;
T:TN; **U:**FSC TN; **W:**FSTN Black/white;
X:FFSTN; **Y:**STN Yellow;

LCD Type:

R: Reflective/Positive;
S : Reflective/Negative ;
F : Transflective/Positive ;
G: Transflective/Negative ;
U: Transmissive/Positive ;
T: Transmissive/Negative ; **N:**Others

Temperature Range & View Direction:

General Purpose : **1:**6H **2:**12H **3:**3H **4:**9H **5:**Others
High Performance: **6:**6H **7:**12H **8:**3H **9:**9H **0:**Others

STD Product Serial No.: 01~99

Customer Made Serial No.: A1,A2...A9,B1,B2...B9,C1..

Display Function:

Segment Number / Characters Lines / Column and Row Dots
/ Length * Width of Other

Display Type:

C:Character Type; **G:**Graphic Type; **S:**Segment Type; **O:**Other

Package Type:

B:COB; **F:**COF; **G:**COG; **H:**Heat Seal; **S:**SMT; **T:**TAB; **O:**Others

EVERVISION	MODEL NO.		PAGE
	VGG644810-6UFLWB	SPEC SAMPLE	5

4. Application

This specification is applied to the 5.7 inch VGA supported TFT-LCD module With projected capacitive touch (PCT) and can display true 262,144 colors(6 bit/ color). The module is designed for OA, Car TV application and other electronic products which require flat panel display of digital signal interface. This module is composed of a 5.7”TFT-LCD panel, a driver circuit and backlight unit and used as the input devices for general electric appliances via both finger and Capacitive stylus pen.

5. Features

- VGA (640×480 pixels) resolution.
- Digital 18 bit parallel RGB.
- Dot inversion mode with stripe type.
- LED drive circuit is built in this module to provide PWM Dimmer function
- Projected Capacitive Touch
 - I²C Interface
 - Multi Touch (Ten points)

6. General Specifications

Item	Specifications	Unit
Screen Size	5.7 (Diagonal)	inch
Display Format	640RGB(H)×480(V)	dot
Active Area	115.2(H)×86.4(V)	mm
Dot Size	0.060(H)×0.180(V)	mm
Pixel Configuration	RGB Vertical Stripe	-
Display Mode	TN Type Transmissive Mode Normally White	-
Surface Treatment	Clear(7H)	-
Viewing Direction	6 O'clock (The Gray Inversion will appear at this direction)	-
Outline Dimension	144.0(H)×104.6(W)×14.6(D)	mm
Weight	194	g
RoHS Compliance	Evervision certifies this product to be in compliance with European Union Directive 2011/65/EU on the restriction of certain hazardous substances in electrical and electronic equipment.	-

EVERVISION	MODEL NO.		PAGE
	VGG644810-6UFLWB	SPEC SAMPLE	6

7. Absolute Maximum Ratings

7.1 Absolute Ratings of Environment

Item	Symbol	Value		Unit	Note
		Min.	Max.		
Storage Temperature	T _{ST}	-30	+80	°C	(1)(2)
Operating Ambient Temperature	T _{OP}	-20	+70	°C	(1)(2)

Note1: Background color changes slightly depending on ambient temperature.

This phenomenon is reversible.

Note2: Please refer to item of RELIABILITY.

7.2 Electrical Absolute Ratings

7.2.1 TFT-LCD Module

(Ta=25±2°C, GND=VSS=0V)

Item	Symbol	Value		Unit	Note
		Min.	Max.		
Digital Power Supply Voltage	VCC	-0.3	4.3	V	-

7.2.2 LED Driver Absolute Maximum Ratings

(Ta=25±2°C)

Item	Symbol	Value		Unit	Note
		Min.	Max.		
LED Driver Supply Voltage	VLED	-0.3	17	V	(1)
LED Driver PWM	PWM	-0.3	6	V	(1)

Note (1) Permanent damage to the device may occur if maximum values are exceeded or reverse voltage is loaded.

EVERVISION	MODEL NO.		PAGE
	VGG644810-6UFLWB	SPEC SAMPLE	7

8. Electrical Characteristics

8.1 TFT-LCD Module

(Ta=25±2°C)

Item	Symbol	Value			Unit	Note
		Min.	Typ.	Max.		
Power Supply Voltage	VCC	3.0	3.3	3.6	V	-
Input High Threshold Voltage	VIH	0.7VCC	-	VCC	V	-
Input Low Threshold Voltage	VIL	0	-	0.3VCC	V	-
Current dissipation	ICC	-	140	196	mA	-
Power Consumption	PL	-	0.462	0.504	W	(1)
Frame Frequency	FV	-	60	-	Hz	-
Dot Clock	DCLK	-	25.175	-	MHz	-

Note (1) The specified power consumption is under the conditions at VCC=3.3V, FV=60Hz, whereas a power dissipation check pattern below is displayed.

Black Pattern / 0 Gray

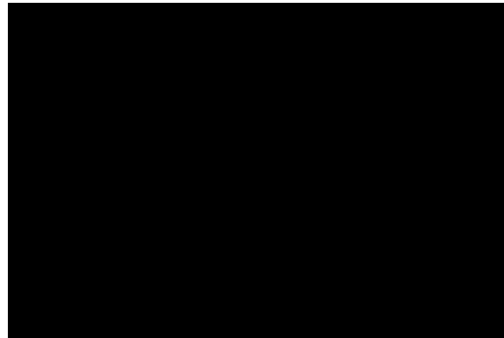

Active Area

8.2 LED Driver Unit

(Ta=25±2°C)

Item	Symbol	Value			Unit	Note
		Min.	Typ.	Max.		
Voltage of LED Driver Unit	V _{LED(DU)}	11.2	12.0	12.6	V	-
Current of LED Driver Unit	I _{LED(DU)}	-	180	252	mA	B/L=200mA
Current of LED Driver Unit	I _{LED(DU)}	-	130	182	mA	B/L=150mA
Current of LED Driver Unit	I _{LED(DU)}	-	80	112	mA	B/L=100mA
Dimmer signal Low voltage	VPWML	-	-	0.2	V	-
Dimmer signal High voltage	VPWMH	4	5.0	5.5	V	-
Dimmer frequency	fPWM	-	120	-	Hz	-
PWM Pulse width	TPWMH	10			us	-
LED Life Time(25°C)	-	40000	50000	-	hr	-

8.3 Projected Capacitive Touch

Item	Symbol	Value			Unit	Note
		Min.	Typ.	Max.		
Operating Voltage	VDD	3.0	3.3	3.6	V	-
Power Supply Current	IDD	-	17.5	24.5	mA	(1)
Input High Threshold Voltage	V _{IH}	0.7VDD	-	VDD	V	-
Input Low Threshold Voltage	V _{IL}	-0.3	-	0.3VDD	V	-
Output High Threshold Voltage	V _{OH}	0.7VDD	-	-	V	-
Output Low Threshold Voltage	V _{OL}	-	-	0.3VDD	V	-
Power Consumption	P _L	-	57.75	80.85	mW	@3.3V
Report Rate	R _R	-	60	-	Hz	-
Interface	I ² C					-
Function	Multi Touch					-

Note (1) This test condition is touched with 10 points.

9. Block Diagram

9.1 TFT-LCD Module with Backlight Unit

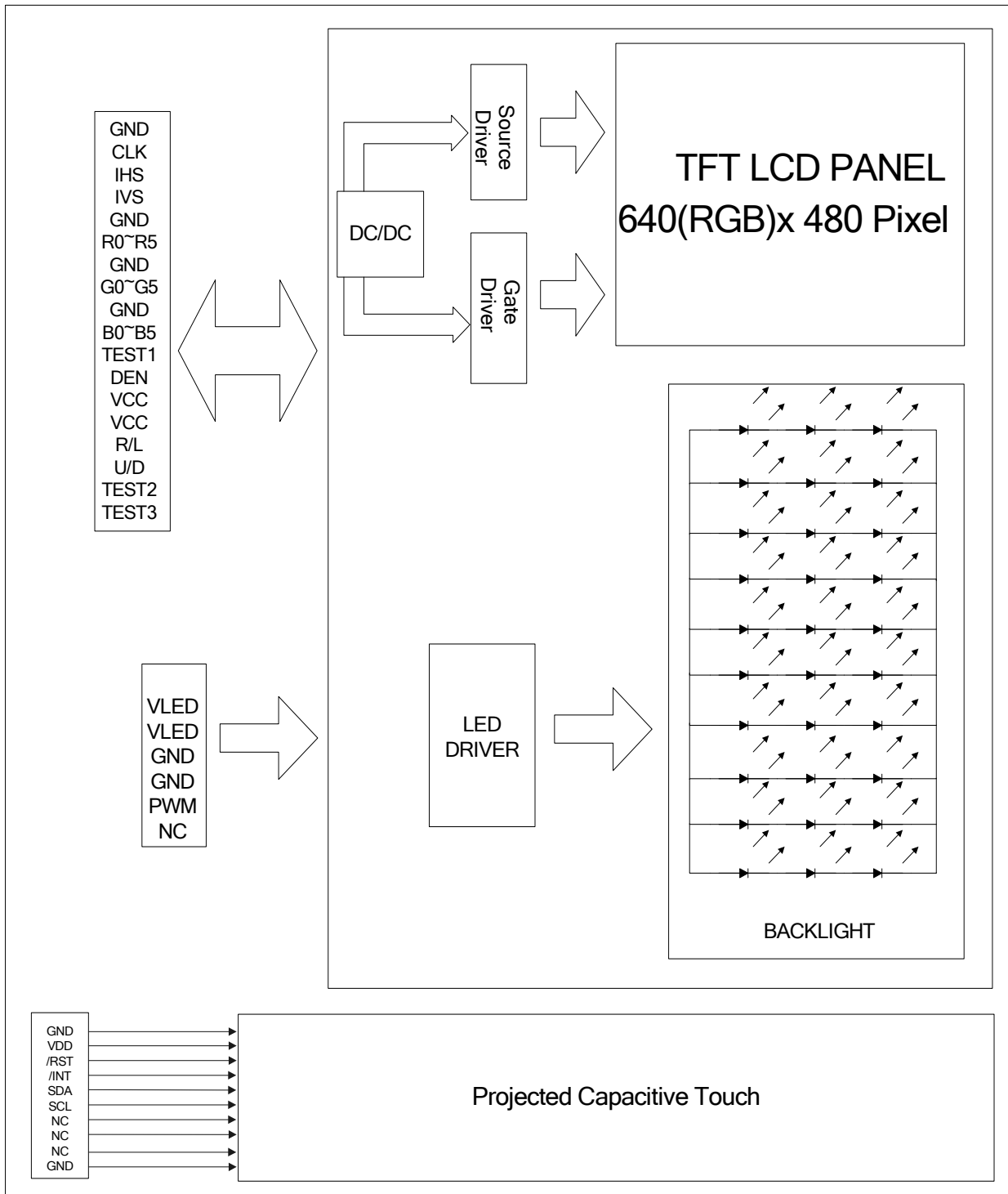

10. Input / Output Terminals Pin Assignment

10.1 TFT-LCD Module

Connector: CIVILUX CF25331D0R0-05

Pin No.	Symbol	I/O	Description
1	GND	I	Ground
2	CLK	I	Clock signal
3	IHS	I	Horizontal synchronous signal
4	IVS	I	Vertical synchronous signal
5	GND	I	Ground
6	R0	I	RED data (LSB)
7	R1	I	RED data
8	R2	I	RED data
9	R3	I	RED data
10	R4	I	RED data
11	R5	I	RED data(MSB)
12	GND	I	Ground
13	G0	I	GREEN data(LSB)
14	G1	I	GREEN data
15	G2	I	GREEN data
16	G3	I	GREEN data
17	G4	I	GREEN data
18	G5	I	GREEN data(MSB)
19	GND	I	Ground
20	B0	I	Blue data(LSB)
21	B1	I	Blue data
22	B2	I	Blue data
23	B3	I	Blue data
24	B4	I	Blue data
25	B5	I	Blue data(MSB)
26	TEST1	I	TEST1(Please be sure to connect 26pin with ground)
27	DEN	I	Input data enable control
28	VCC	I	+3.3V power supply
29	VCC	I	+3.3V power supply

Pin No.	Symbol	I/O	Description
30	R/L	I	Selection signal for horizontal scanning direction. Note (1)
31	U/D	I	Selection signal for vertical scanning direction. Note (1)
32	TEST2	I	TEST2(to be open, or connected to either GND or Vcc)
33	TEST3	I	TEST3(Please be sure to connect 33pin with ground)

Note (1)



R/L=L, U/D=H



R/L=H, U/D=H



R/L=L, U/D=L



R/L=H, U/D=L

10.2 Backlight Unit

Connector: CVILUX CI1106M1HR0-LF

Pin No.	Symbol	Description
1	VLED	LED drive circuit power supply (12V)
2	VLED	LED drive circuit power supply (12V)
3	GND	Ground
4	GND	Ground
5	PWM	PWM Dimmer
6	NC	NO CONNECTION

JUMP: HCH HDS502-E

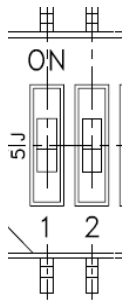

PIN 1	PIN2	Result
ON	ON	200mA
ON	OFF	150mA
OFF	ON	150mA
OFF	OFF	100mA

10.3 Projected Capacitive Touch

Connector: CVILUX CF25101D0R0-05

Pin No.	Symbol	I/O	Description
1	GND	I	System ground.
2	VDD	I	+3.3V power supply.
3	/RST	I	External reset signal, active low.
4	/INT	O	Interrupt signal, active low, asserted to request Host start a new transaction.
5	SDA	I/O	I ² C data signal.
6	SCL	I	I ² C clock signal.
7	NC	-	Not Connection
8	NC	-	Not Connection
9	NC	-	Not Connection
10	GND	I	System ground.

10.4 Color Data Input Assignment

The brightness of each primary color(red, green and blue) is based on the 6 bit gray scale data input for the color. The higher the binary input, the brighter the color. The table provides the assignment of color versus data input.

Color		Data Signal																	
		Red						Green						Blue					
		D05	D04	D03	D02	D01	D00	D15	D14	D13	D12	D11	D10	D25	D24	D23	D22	D21	D20
Basic Colors	Black	0	0	0	0	0	0	0	0	0	0	0	0	0	0	0	0	0	0
	Red	1	1	1	1	1	1	0	0	0	0	0	0	0	0	0	0	0	0
	Green	0	0	0	0	0	0	1	1	1	1	1	1	0	0	0	0	0	0
	Blue	0	0	0	0	0	0	0	0	0	0	0	0	1	1	1	1	1	1
	Cyan	0	0	0	0	0	0	1	1	1	1	1	1	1	1	1	1	1	1
	Magenta	1	1	1	1	1	1	0	0	0	0	0	0	0	1	1	1	1	1
	Yellow	1	1	1	1	1	1	1	1	1	1	1	1	0	0	0	0	0	0
	White	1	1	1	1	1	1	1	1	1	1	1	1	1	1	1	1	1	1
Gray Scale Of RED	Red(0) / Dark	0	0	0	0	0	0	0	0	0	0	0	0	0	0	0	0	0	0
	Red(1)	0	0	0	0	0	1	0	0	0	0	0	0	0	0	0	0	0	0
	Red(2)	0	0	0	0	1	0	0	0	0	0	0	0	0	0	0	0	0	0
	:	:	:	:	:	:	:	:	:	:	:	:	:	:	:	:	:	:	:
	:	:	:	:	:	:	:	:	:	:	:	:	:	:	:	:	:	:	:
	Red(61)	1	1	1	1	0	1	0	0	0	0	0	0	0	0	0	0	0	0
	Red(62)	1	1	1	1	1	0	0	0	0	0	0	0	0	0	0	0	0	0
	Red(63)	1	1	1	1	1	1	0	0	0	0	0	0	0	0	0	0	0	0
Gray Scale Of Green	Green(0) / Dark	0	0	0	0	0	0	0	0	0	0	0	0	0	0	0	0	0	0
	Green(1)	0	0	0	0	0	0	0	0	0	0	0	1	0	0	0	0	0	0
	Green(2)	0	0	0	0	0	0	0	0	0	0	1	0	0	0	0	0	0	0
	:	:	:	:	:	:	:	:	:	:	:	:	:	:	:	:	:	:	:
	:	:	:	:	:	:	:	:	:	:	:	:	:	:	:	:	:	:	:
	Green(61)	0	0	0	0	0	0	1	1	1	1	0	1	0	0	0	0	0	0
	Green(62)	0	0	0	0	0	0	1	1	1	1	1	0	0	0	0	0	0	0
	Green(63)	0	0	0	0	0	0	1	1	1	1	1	1	0	0	0	0	0	0
Gray Scale Of Blue	Blue(0) / Dark	0	0	0	0	0	0	0	0	0	0	0	0	0	0	0	0	0	0
	Blue(1)	0	0	0	0	0	0	0	0	0	0	0	0	0	0	0	0	0	1
	Blue(2)	0	0	0	0	0	0	0	0	0	0	0	0	0	0	0	0	1	0
	:	:	:	:	:	:	:	:	:	:	:	:	:	:	:	:	:	:	:
	:	:	:	:	:	:	:	:	:	:	:	:	:	:	:	:	:	:	:
	Blue(61)	0	0	0	0	0	0	0	0	0	0	0	0	1	1	1	1	0	1
	Blue(62)	0	0	0	0	0	0	0	0	0	0	0	0	1	1	1	1	1	0
	Blue(63)	0	0	0	0	0	0	0	0	0	0	0	0	1	1	1	1	1	1

10.5 Power ON/OFF Sequence

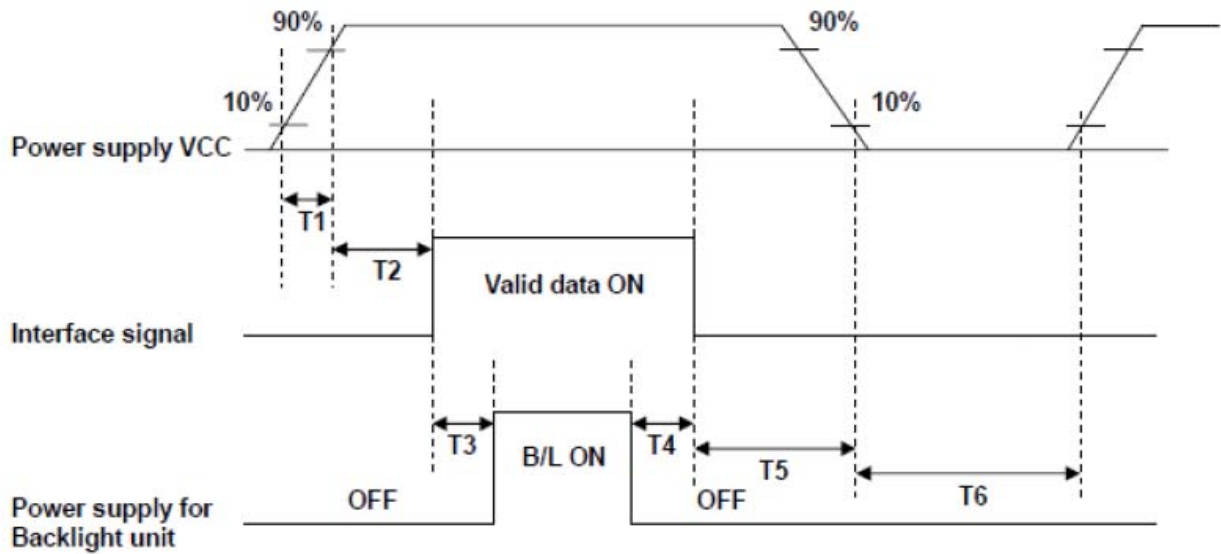

POWER SEQUENCE TABLE

Parameter	Value			Units
	Min.	Typ	Max.	
T1	0.5	-	10	ms
T2	0	-	50	ms
T3	500	-	-	ms
T4	500	-	-	ms
T5	0	-	50	ms
T6	1000	-	-	ms

EVERVISION	MODEL NO.		PAGE
	VGG644810-6UFLWB	SPEC SAMPLE	15

11. Interface Timing

11.1 Input Signal Characteristics

PARAMETER	Symbol	Min.	Typ.	Max.	Unit
HS setup time	T_{hst}	10	-	-	ns
HS hold time	T_{hhd}	10	-	-	ns
VS setup time	T_{vst}	10	-	-	ns
VS hold time	T_{vhd}	10	-	-	ns
Data setup time	T_{dsu}	10	-	-	ns
Data hold time	T_{dhd}	10	-	-	ns
DEN setup time	T_{esu}	10	-	-	ns
VS falling to HS falling time on odd field @ RGB mode	T_{HV_O}	-4	0	+4	T_{CPH}
VS falling to HS falling time on even field @ RGB mode	T_{HV_E}	0.4	0.5	0.6	T_H

PARAMETER	Symbol	Spec.			Unit
		Min.	Typ.	Max.	
CLK frequency	F_{CPH}	22.66	25.175	27.69	MHz
CLK period	T_{CPH}	36.11	39.7	44.13	ns
CLK pulse duty	T_{CWH}	40	50	60	%
HS period	T_H	750	800	850	T_{CPH}
HS pulse width	T_{WH}	5	30	-	T_{CPH}
HS-first horizontal data time	T_{HS}	112	144	175	T_{CPH}
Horizontal active data area	T_{HA}	-	640	-	T_{CPH}
VS pulse width	T_{WV}	1	3	5	T_H
First Line Data input time	T_{STV}	-	35	-	T_H
VS period	T_V	515	525	535	T_H

Note: When SYNC mode is used, 1st data start from 144th CLK after HS falling (when $STHD[5:0]=00000$)

11.2 Waveform

11.2.1 Clock and Data input waveforms

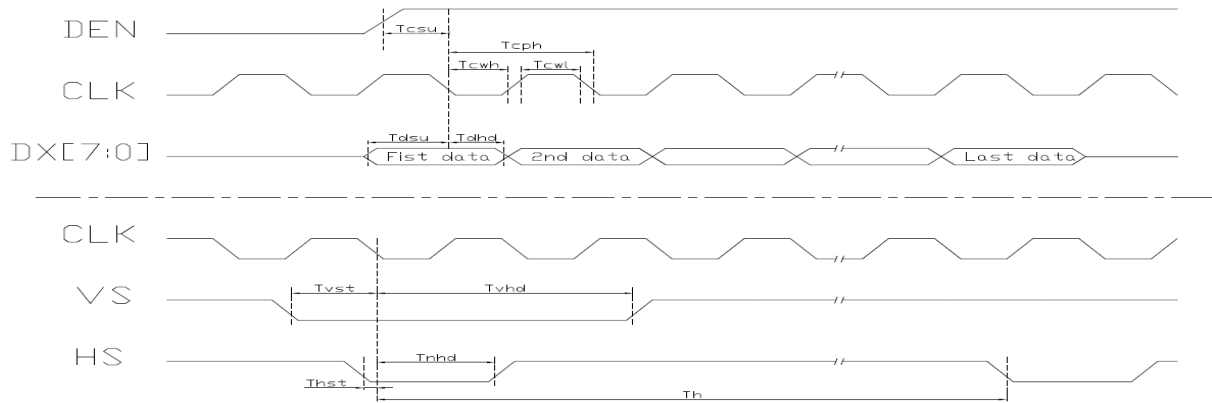

11.2.2 Data input format for RGB Mode

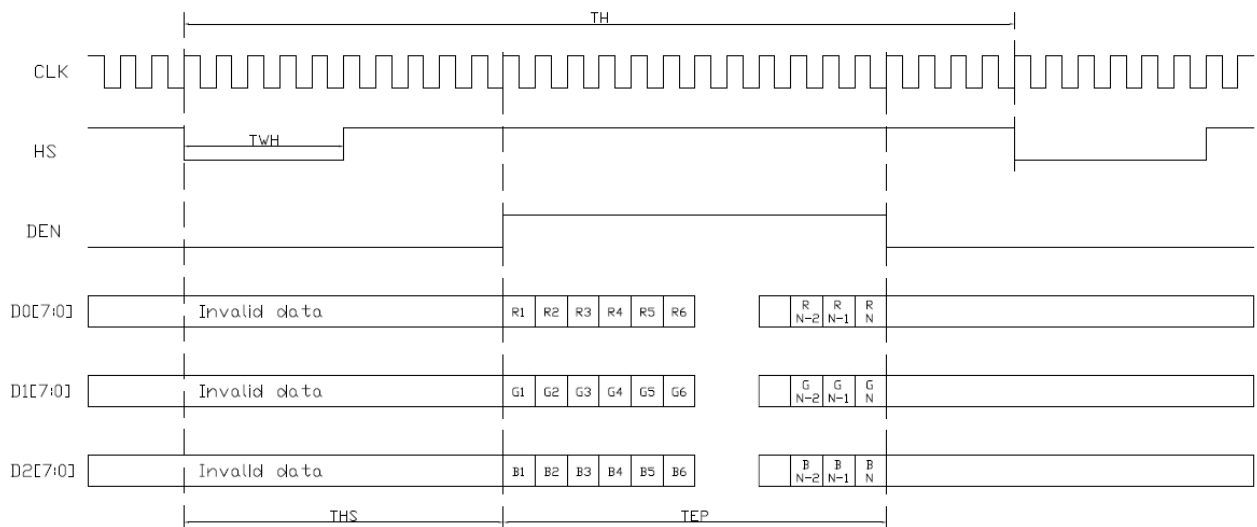

11.2.3 The HS & VS timing of the ODD/EVEN field.

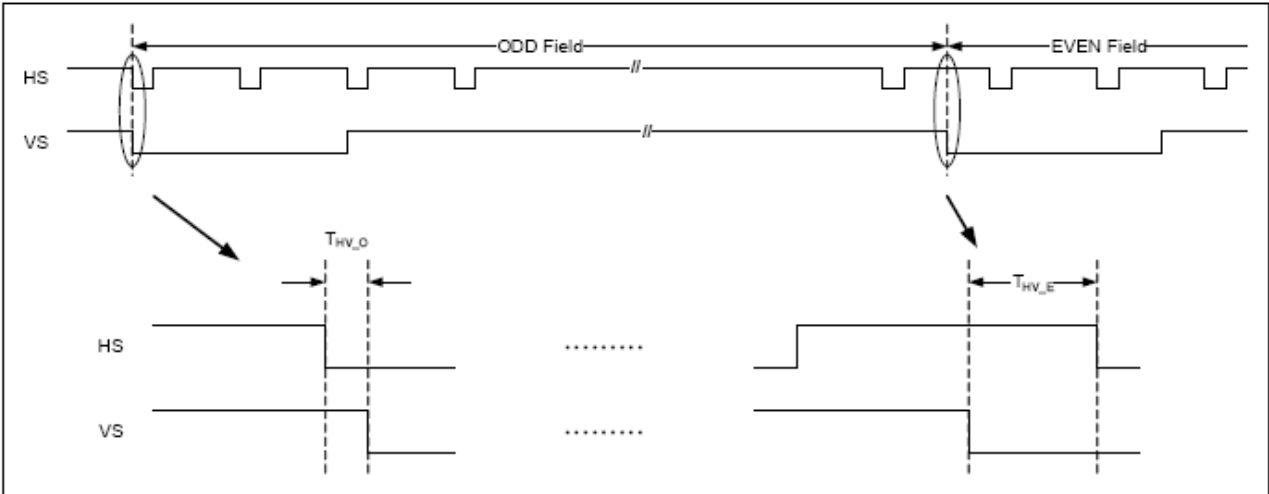

11.3 Timing Requirement of Projected Capacitive Touch

11.3.1 I2C Data Transfer Format

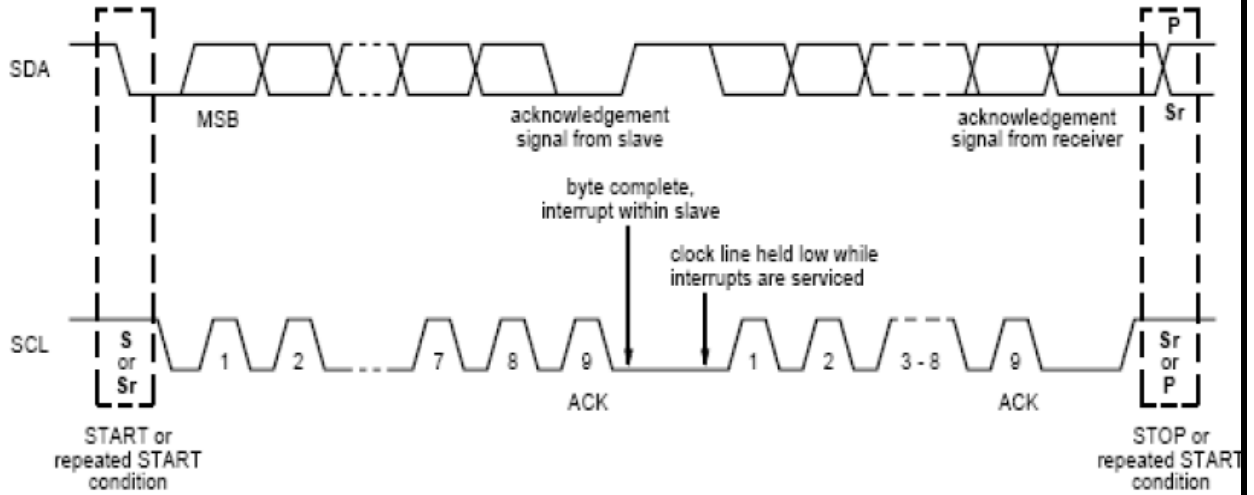

Mnemonics	Description
S	I ² C Start or I ² C Restart
A[6:0]	Slave Address = 7'b0111000
W	1'b0: Write
R	1'b1: Read
C	ACK
P	STOP: the indicate the end of a packet (if this bit is missing, S will indicate the end of the current packet and the beginning of the next packet)

Write N bytes to I2C slave

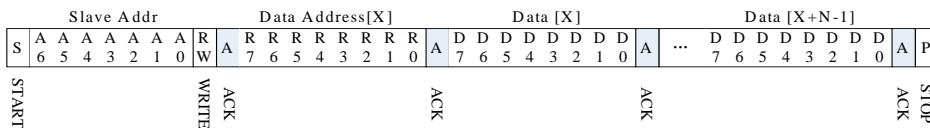

Set Data Address

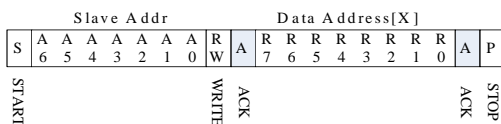

Read X bytes from I²C Slave

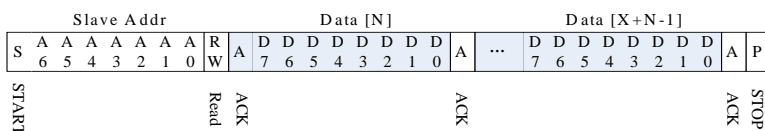

11.3.2 I2C Timing Characteristics

(Ta=25±2°C)

Parameter	Min	Max	Unit
SCL frequency	-	400	kHz
Bus free time between a STOP and START condition	4.7	-	μs
Hold time (repeated) START condition	4.0	-	μs
Data setup time	250	-	ns
Setup time for a repeated START condition	4.7	-	μs
Setup time for STOP condition	4.0	-	μs

11.3.3 Interrupt Trigger Mode

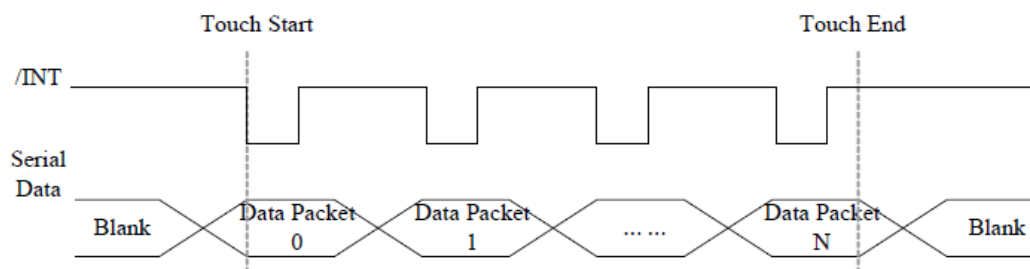

11.3.4 I2C Operating Mode Register Map

Address	Name	Bit 7	Bit 6	Bit 5	Bit 4	Bit 3	Bit 2	Bit 1	Bit 0	Host Access
Op,00h	DEVICE_MODE	Device Mode[2:0]								RW
Op,01h	Reserved									R
Op,02h	TD_STATUS					Number of touch points[3:0]				R
Op,03h	TOUCH1_YH	1 st Event Flag				1 st Touch Y Position[11:8]				R
Op,04h	TOUCH1_YL	1 st Touch Y Position[7:0]								R
Op,05h	TOUCH1_XH	1 st Touch ID[3:0]				1 st Touch X Position[11:8]				R
Op,06h	TOUCH1_XL	1 st Touch X Position[7:0]								R
Op,07h	Reserved									R
Op,08h	Reserved									R
Op,09h	TOUCH2_YH	2 nd Event Flag				2 nd Touch Y Position[11:8]				R
Op,0Ah	TOUCH2_YL	2 nd touch Y Position[7:0]								R

EVERVISION	MODEL NO.		PAGE
	VGG644810-6UFLWB	SPEC SAMPLE	20

Op,0Bh	TOUCH2_XH	2 nd Touch ID[3:0]	2 nd Touch X Position[11:8]	R
Op,0Ch	TOUCH2_XL	2 nd Touch X Position[7:0]		R
Op,0Dh	Reserved			R
Op,0Eh	Reserved			R
Op,0Fh	TOUCH3_YH	3 rd Event Flag	3 rd Touch Y Position[11:8]	R
Op,10h	TOUCH3_YL	3 rd Touch Y Position[7:0]		R
Op,11h	TOUCH3_XH	3 rd Touch ID[3:0]	3 rd Touch X Position[11:8]	R
Op,12h	TOUCH3_XL	3 rd Touch X Position[7:0]		R
Op,13h	Reserved			R
Op,14h	Reserved			R
Op,15h	TOUCH4_YH	4 th Event Flag	4 th Touch Y Position[11:8]	R
Op,16h	TOUCH4_YL	4 th Touch Y Position[7:0]		R
Op,17h	TOUCH4_XH	4 th Touch ID[3:0]	4 th Touch X Position[11:8]	R
Op,18h	TOUCH4_XL	4 th Touch X Position[7:0]		R
Op,19h	Reserved			R
Op,1Ah	Reserved			R
Op,1Bh	TOUCH5_YH	5 th Event Flag	5 th Touch Y Position[11:8]	R
Op,1Ch	TOUCH5_YL	5 th Touch Y Position[7:0]		R
Op,1Dh	TOUCH5_XH	5 th Touch ID[3:0]	5 th Touch X Position[11:8]	R
Op,1Eh	TOUCH5_XL	5 th Touch X Position[7:0]		R
Op,1Fh	Reserved			R
Op,20h	Reserved			R
Op,21h	TOUCH6_YH	6 th Event Flag	6 th Touch Y Position[11:8]	R
Op,22h	TOUCH6_YL	6 th Touch Y Position[7:0]		R
Op,23h	TOUCH6_XH	6 th Touch ID[3:0]	6 th Touch X Position[11:8]	R
Op,24h	TOUCH6_XL	6 th Touch X Position[7:0]		R
Op,25h	Reserved			R
Op,26h	Reserved			R
Op,27h	TOUCH7_YH	7 th Event Flag	7 th Touch Y Position[11:8]	R

EVERVISION	MODEL NO.		PAGE
	VGG644810-6UFLWB	SPEC SAMPLE	21

Op,28h	TOUCH7_YL	7 th Touch Y Position[7:0]		R
Op,29h	TOUCH7_XH	7 th Touch ID[3:0]	7 th Touch X Position[11:8]	R
Op,2Ah	TOUCH7_XL	7 th Touch X Position[7:0]		R
Op,2Bh	Reserved			R
Op,2Ch	Reserved			R
Op,2Dh	TOUCH8_YH	8 th Event Flag	8 th Touch Y Position[11:8]	R
Op,2Eh	TOUCH8_YL	8 th Touch Y Position[7:0]		R
Op,2Fh	TOUCH8_XH	8 th Touch ID[3:0]	8 th Touch X Position[11:8]	R
Op,30h	TOUCH8_XL	8 th Touch X Position[7:0]		R
Op,31h	Reserved			R
Op,32h	Reserved			R
Op,33h	TOUCH9_YH	9 th Event Flag	9 th Touch Y Position[11:8]	R
Op,34h	TOUCH9_YL	9 th Touch Y Position[7:0]		R
Op,35h	TOUCH9_XH	9 th Touch ID[3:0]	9 th Touch X Position[11:8]	R
Op,36h	TOUCH9_XL	9 th Touch X Position[7:0]		R
Op,37h	Reserved			R
Op,38h	Reserved			R
Op,39h	TOUCH10_YH	10 th Event Flag	10 th Touch Y Position[11:8]	R
Op,3Ah	TOUCH10_YL	10 th Touch Y Position[7:0]		R
Op,3Bh	TOUCH10_XH	10 th Touch ID[3:0]	10 th Touch X Position[11:8]	R
Op,3Ch	TOUCH10_XL	10 th Touch X Position[7:0]		R
Op,3Dh	Reserved			R
Op,3Eh	Reserved			R

EVERVISION	MODEL NO.		PAGE
	VGG644810-6UFLWB	SPEC SAMPLE	22

11.3.5 DEVICE_MODE

This register is the device mode register, configure it to determine the current mode of the chip.

Address	Bit Address	Register Name	Description
Op,00h	6:4	Device Mode [2:0]	000b Normal operating Mode 001b System Information Mode (Reserved) 100b Test Mode – read raw data (Reserved)

11.3.6 TD_STATUS

This register is the Touch Data status register.

Address	Bit Address	Register Name	Description
Op,02h	3:0	Number of touch points[3:0]	How many points detected. 1-10 is valid.

11.3.7 TOUCHn_YH (n:1-10)

This register describes MSB of the Y coordinate of the nth touch point and the corresponding event flag.

Address	Bit Address	Register Name	Description
Op,03h ~ Op,39h	7:6	Event Flag	00b: Put Down 01b: Put Up 10b: Contact 11b: No event
	5:4		Reserved
	3:0	Touch Y Position [11:8]	MSB of Touch Y Position in pixels

11.3.8 TOUCHn_YL (n:1-10)

This register describes LSB of the Y coordinate of the nth touch point.

Address	Bit Address	Register Name	Description
Op,04h ~ Op,3Ah	7:0	Touch Y Position [7:0]	LSB of the Touch Y Position in pixels

11.3.9 TOUCHn_XH (n:1-10)

This register describes MSB of the X coordinate of the nth touch point and corresponding touch ID.

Address	Bit Address	Register Name	Description
Op,05h ~ Op,3Bh	7:4 3:0	Touch ID[3:0] Touch X Position [11:8]	Touch ID of Touch Point MSB of Touch X Position in pixels

11.3.10 TOUCHn_XL (n:1-10)

This register describes LSB of the X coordinate of the nth touch point.

Address	Bit Address	Register Name	Description
Op,06h ~ Op,3Ch	7:0	Touch X Position [7:0]	LSB of The Touch X Position in pixels

11.4 POWER ON/Reset/Wake Sequence

Reset should be pulled down to be low before powering on and powering down. I2C shouldn't be used by other devices during Reset time after VDD powering on (Trtp). INT signal will be sent to the host after initializing all parameters and then start to report points to the host. If Power is down, the voltage of supply must be below 0.3V and Tpd is more than 1ms.

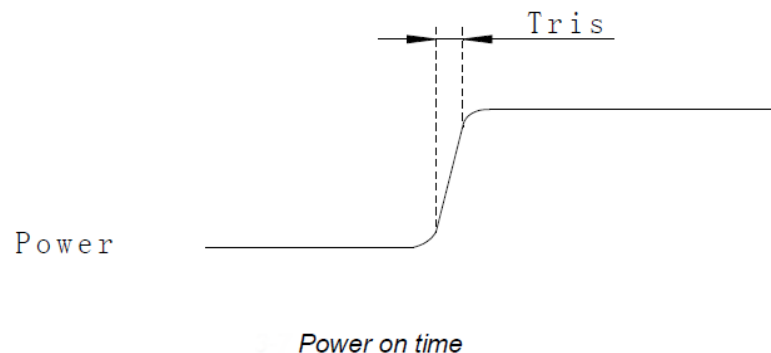

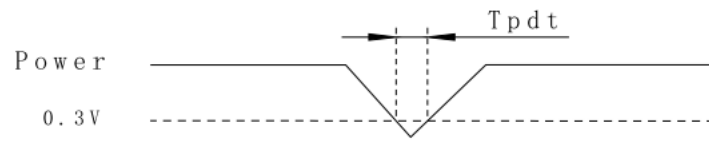

Power Cycle requirement

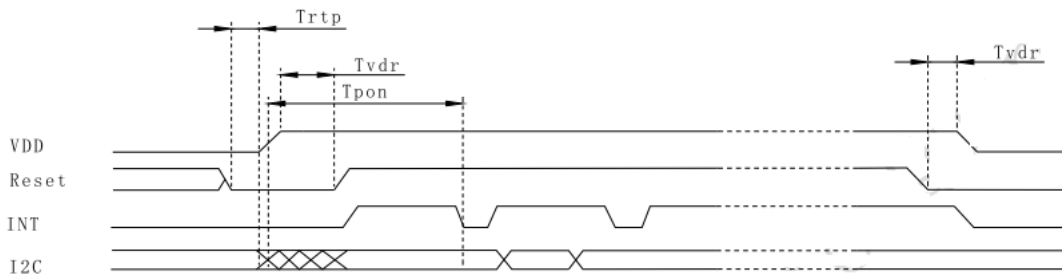

Power on Sequence

Reset time must be enough to guarantee reliable reset, the time of starting to report point after resetting approach to the time of starting to report point after powering on.

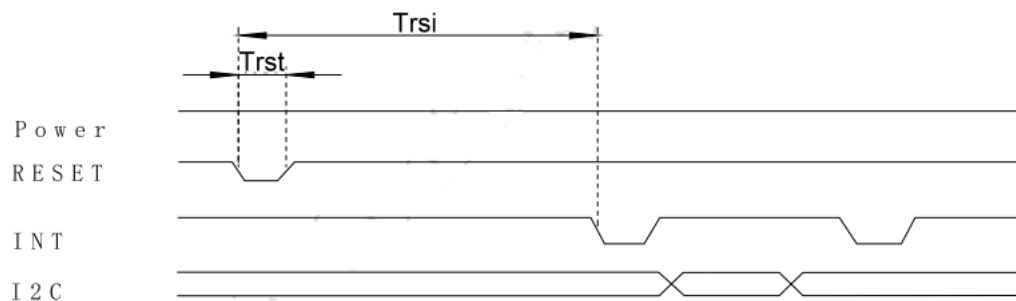

Reset Sequence

Power on/Reset Sequence Parameters

Parameter	Description	Min	Max	Units
T_{ris}	Rise time from 0.1VDD to 0.9VDD	--	5	ms
$T_{pd t}$	Time of the voltage of supply being below 0.3V	5	--	ms
T_{rtp}	Time of resetting to be low before powering on	100	--	μs
T_{pon}	Time of starting to report point after powering on	--	200	ms
$T_{vd r}$	Reset time after VDD powering on	1	--	ms
T_{rsi}	Time of starting to report point after resetting	--	200	ms
T_{rst}	Reset time	1	--	ms

12. Optical Characteristics

The optical characteristics should be measured in a dark environment (≤ 1 lux) or equivalent state with the methods shown in Note (4).

Item		Symbol	Conditions	Min.	Typ.	Max.	Unit	Note
Contrast Ratio		CR	$\theta_x=0^\circ, \theta_y=0^\circ$	200	(350)	-	-	(2)
Response Time		T_R	Viewing	-	15	-	ms	(3)
		T_F	Normal Angle	-	35	-	ms	
Luminance (Center)		Y	B/L=200mA	520	(600)	-	cd/m ²	(4)
			B/L=150mA	390	(450)	-	cd/m ²	
			B/L=100mA	260	(300)	-	cd/m ²	
Brightness uniformity		BUNI		80	(85)	-	%	(5)
Color Chromaticity		Red	R_x	0.570	0.620	0.670	-	(1),(4)
			R_y	0.300	0.350	0.400	-	
		Green	G_x	0.315	0.365	0.415	-	
			G_y	0.495	0.545	0.595	-	
		Blue	B_x	0.095	0.145	0.195	-	
			B_y	0.055	0.105	0.155	-	
		White	W_x	0.270	0.320	0.370	-	
			W_y	0.305	0.355	0.405	-	
Viewing Angle		Horizontal	θ_{x+}	55	(65)	-	deg.	
			θ_{x-}	55	(65)	-		
		Vertical	θ_{y+}	45	(55)	-		
			θ_{y-}	55	(65)	-		

Note (1) Definition of Viewing Angle (θ_x , θ_y):

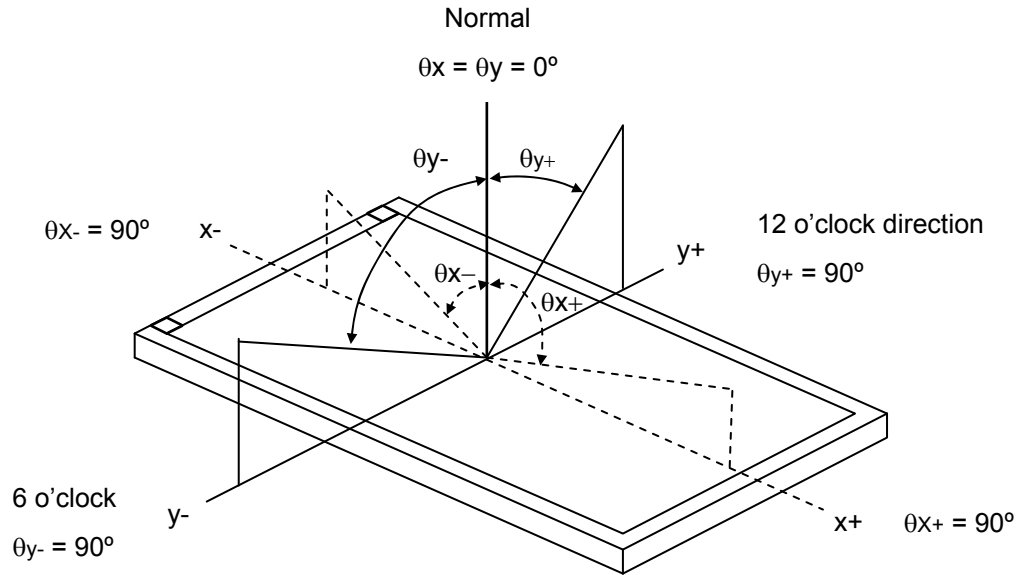

Note (2) Definition of Contrast Ratio (CR):

$$\text{Contrast ratio (CR)} = \frac{\text{Luminance measured when LCD on the "White" state}}{\text{Luminance measured when LCD on the "Black" state}}$$

Note (3) Definition of Response Time (T_R , T_F):

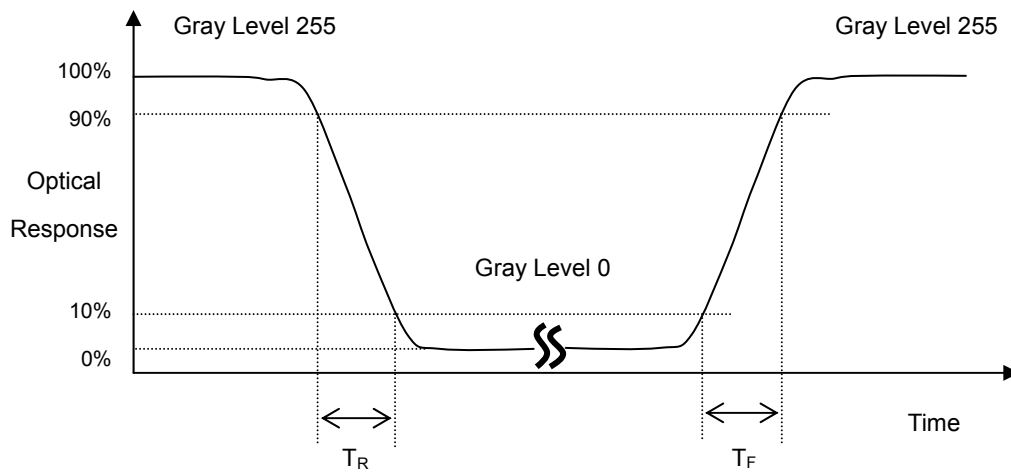

Note (4) Measurement Set-Up:

The LCD module should be stabilized at a given temperature for 30 minutes to avoid abrupt temperature change during measuring. In order to stabilize the luminance, the measurement should be executed after lighting Backlight for 30 minutes in a dark room or equivalent condition.

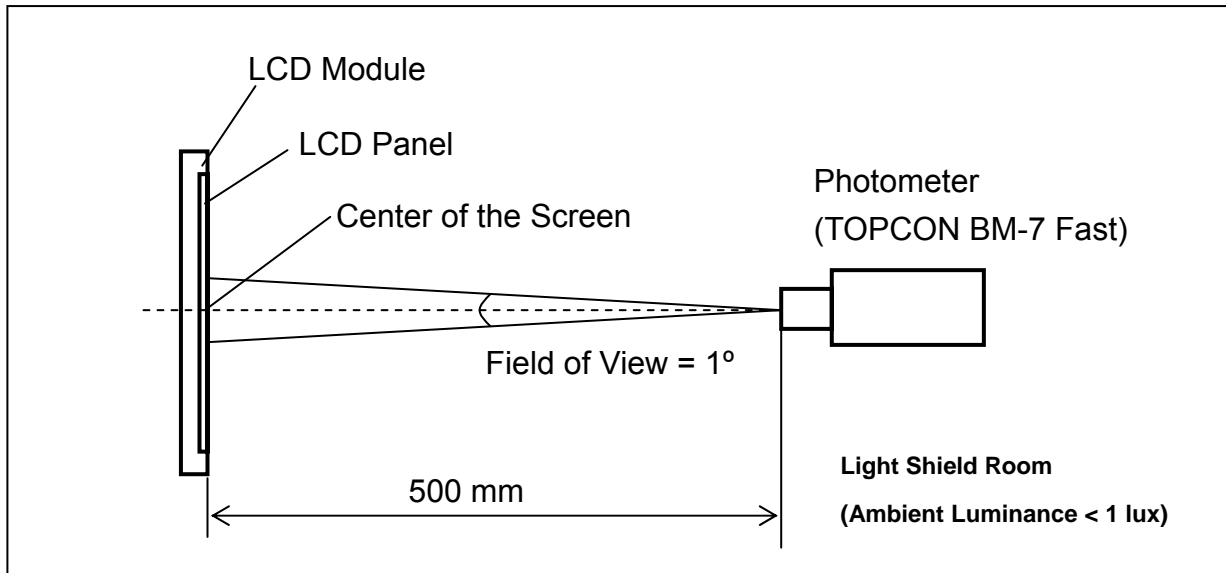

Note (5) Definition of brightness uniformity

$$\text{Brightness uniformity} = (\text{Min Luminance of 9 points}) / (\text{Max Luminance of 9 points}) \times 100\%$$

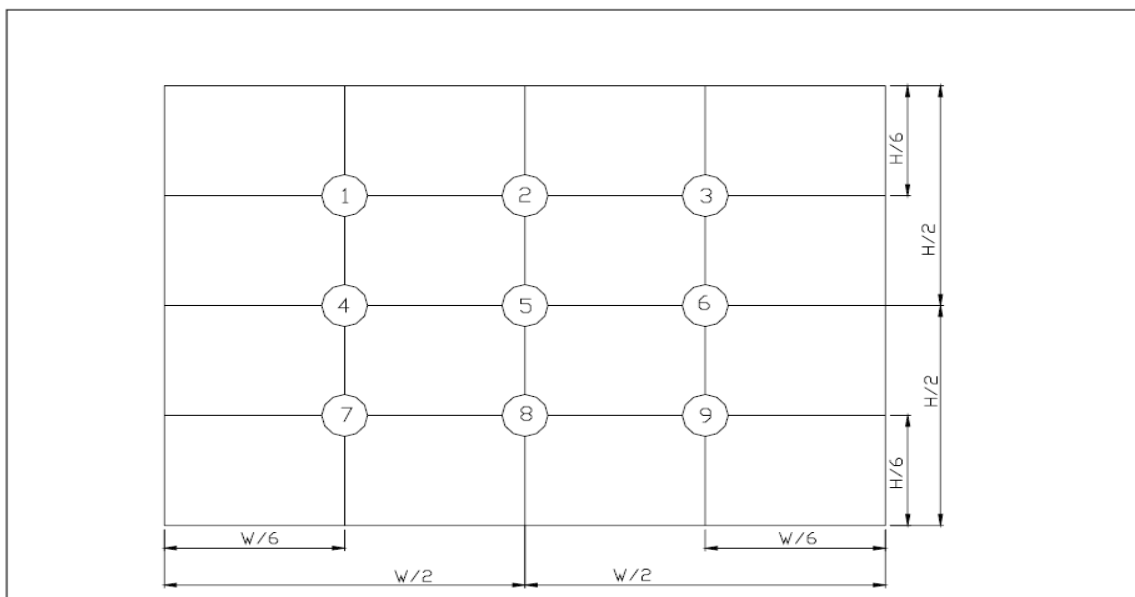

(單位 : mm)

EVERVISION	MODEL NO.		PAGE
	VGG644810-6UFLWB	SPEC SAMPLE	28

13. Reliability Test

No.	Test Items	Test Condition	Remark
1	High Temperature Storage Test	T _a = 80°C 240 hours	(1),(3),(4)
2	Low Temperature Storage Test	T _a = -30°C 240 hours	(1),(3),(4)
3	High Temperature Operation Test	T _s = 70°C 240 hours	(2),(3),(4)
4	Low Temperature Operation Test	T _a = -20°C 240 hours	(1),(3),(4)
5	High Temperature and High Humidity Operation Test	T _a =60°C 90%RH 240 hours	(3), (4)
6	Electro Static Discharge Test (non-operating)	-Panel Surface/Top Case : 150pF, 330Ω Air : ±15kV, Contact: ±8kV	(3)
7	Mechanical Shock Test (non-operating)	Half sine wave, 100G, 6ms 3 times shock of each six surfaces	(3)
8	Vibration Test (non-operating)	Sine wave:10 ~ 55 ~ 10Hz amplitude:1.5mm 3 axis, 2 hours/axis	(3)
9	Thermal Shock Test (non-operating)	-20°C (30min) ~ 70°C (30min) ,10 cycles	(3) , (4)
10	Drop Test(with Carton)	Height : 80cm 1 corner, 3 edges, 6 surfaces	(3)

Note 1 : T_a is the ambient temperature of samples.

Note 2 : T_s is the temperature of panel' s surface.

Note 3 : In the standard condition, there shall be no practical problem that may affect the display function.
After the reliability test, the product only guarantees operation, but don' t guarantee all of the cosmetic specification.

Note 4 : Before cosmetic and function test, the product must have enough recovery time, at least 2 hours at room temperature.

14. Packaging

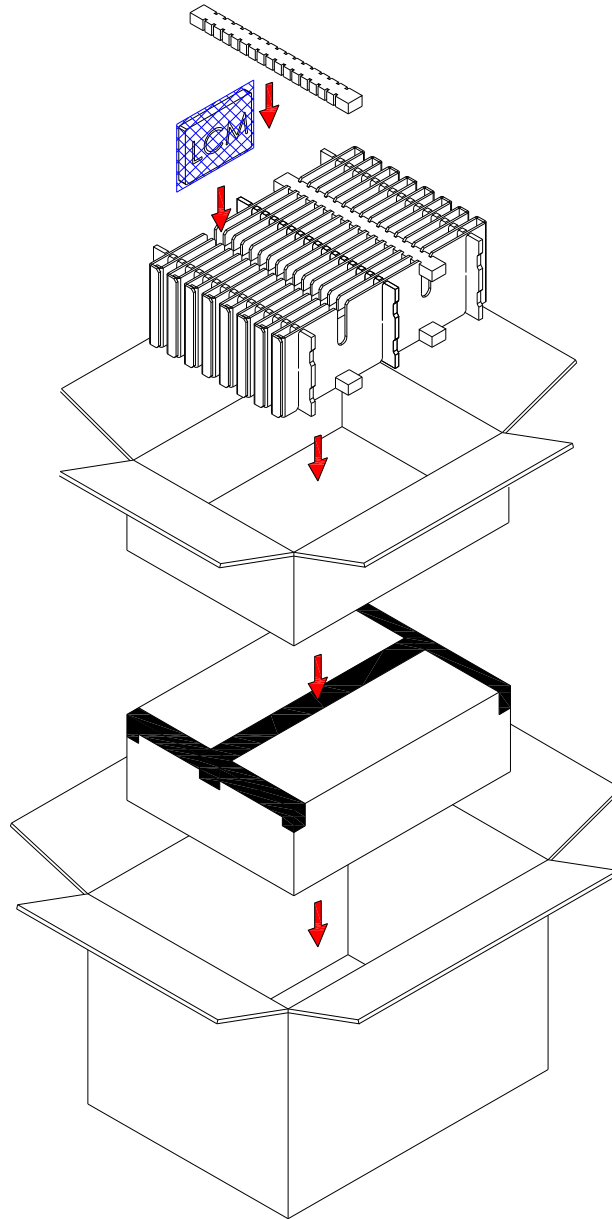

PARTS LIST

	ITEM	SIZE(LxWxH) unit:mm	MATERIAL	Q.T.Y	NOTE
1	STATIC SHIEDING BAGS	300.0x145.0x0.09		60	
2	EPE PAD	345.0x30.0x20.0	EPE	8	
3	CARD BOARD	345.0x150.0x3.5	CARTON	6	
4	CARD BOARD	450.0x23.0x150.0	CARTON	16	
5	INTERNAL BOX	455.0x350.0x164.0	CARTON	2	
6	EXTERNAL BOX	475.0x370.0x375.0	CARTON	1	
7	PRODUCT	144.0x104.6x14.6		60	

EVERVISION	MODEL NO.		PAGE
	VGG644810-6UFLWB	SPEC SAMPLE	30

15. Precautions

15.1 Assembly and Handling Precautions

- (1) Do not apply rough force such as bending or twisting to the module during assembly.
- (2) It's recommended to assemble or to install a module into the user's system in clean working areas. The dust and oil may cause electrical short or worsen the polarizer.
- (3) Don't apply pressure or impulse to the module to prevent the damage of LCD panel and Backlight.
- (4) Always follow the correct power-on sequence when the LCD module is turned on. This can prevent the damage and latch-up of the CMOS LSI chips.
- (5) Do not plug in or pull out the I/F connector while the module is in operation.
- (6) Do not disassemble the module.
- (7) Use a soft dry cloth without chemicals for cleaning, because the surface of polarizer is very soft and easily scratched.
- (8) Moisture can easily penetrate into LCD module and may cause the damage during operation.
- (9) High temperature or humidity may deteriorate the performance of LCD module. Please store LCD module in the specified storage conditions.
- (10) When ambient temperature is lower than 10°C, the display quality might be reduced. For example, the response time will become slow.

15.2 Safety Precautions

- (1) If the liquid crystal material leaks from the panel, it should be kept away from the eyes or mouth. In case of contact with hands, skin or clothes, it has to be washed away thoroughly with soap.
- (2) After the module's end of life, it is not harmful in case of normal operation and storage.

15.3 Terms of Warrant

- (1) Acceptance inspection period
The period is within one month after the arrival of contracted commodity at the buyer's factory site.
- (2) Applicable warrant period
The period is within twelve months since the date of shipping out under normal using and storage conditions.

EVERVISION	MODEL NO.		PAGE
	VGG644810-6UFLWB	SPEC SAMPLE	31

15.4 Caution

This Evervision LCD module has been specifically designed for use only in electronic devices in the areas of audio control, office automation, industrial control, home appliances, etc. The modules should not be used in applications where module failure could result in physical harm or loss of life, and Evervision expressly disclaims any and all liability relating in any way to the use of the module in such applications.

16.Outline Drawing

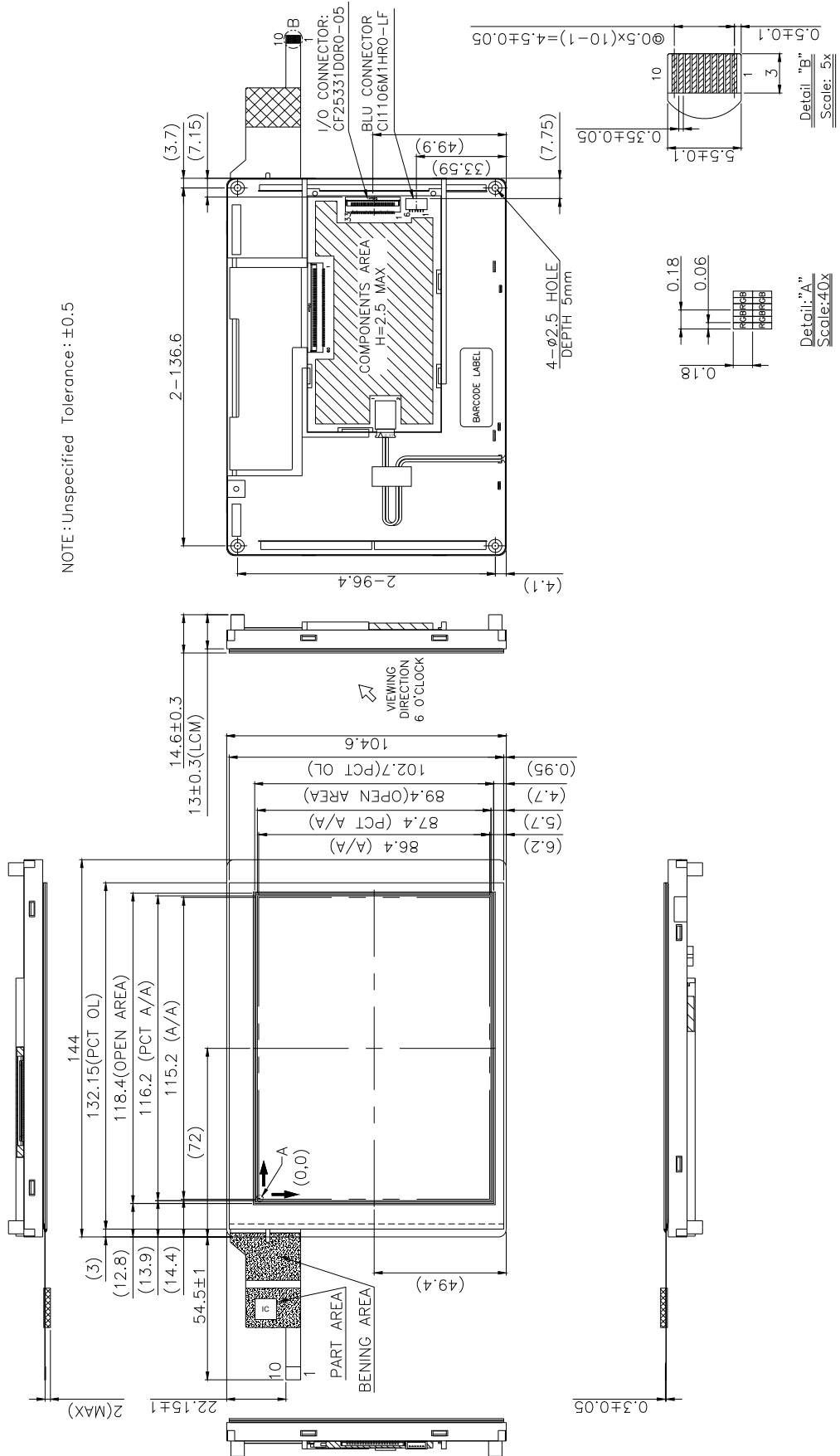

17. Definition of Labels

The bar code nameplate is pasted on each module as illustration, and its definitions are as following explanation.



(a) Module Name : VGG644810-6UFLWB

(b) Serial ID :

A B C D E F G H I J K L

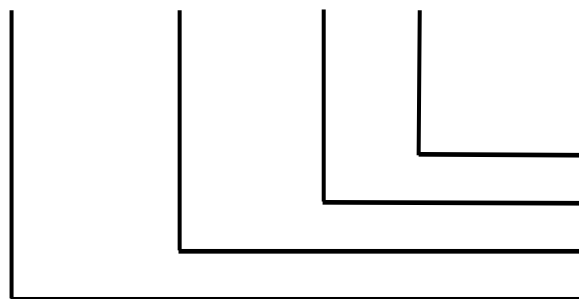

Serial No.
Factory Code
Manufactured Date
Screen Size

Serial ID includes the information as below :

(a) Screen size (Diagonal) : Inch Code (ABCD)

3.5" → 0350

10.4" → 1040

(b) Manufactured Date : Year, Month, Day (EFG)

Year (E)

Year	2000	2001	2002	2003	2004	2005	2006	2007	2008	2009
Mark	0	1	2	3	4	5	6	7	8	9
Year	2010	2011	2012	2013	2014	2015	2016	2017	2018	2019
Mark	A	B	C	D	E	F	G	H	I	J

EVERVISION	MODEL NO.		PAGE
	VGG644810-6UFLWB	SPEC SAMPLE	34

Month (F)

Month	Jan.	Feb.	Mar.	Apr.	May	Jun.	Jul.	Aug.	Sep.	Oct.	Nov.	Dec.
Mark	1	2	3	4	5	6	7	8	9	A	B	C

Day (G)

Day	1	2	3	4	5	6	7	8	9	10	11	12	13	14	15	16
Mark	1	2	3	4	5	6	7	8	9	A	B	C	D	E	F	G
Day	17	18	19	20	21	22	23	24	25	26	27	28	29	30	31	
Mark	H	I	J	K	L	M	N	O	P	Q	R	S	T	U	V	

(c) Factory Code (H) :

For EVERVISION internal use.

(d) Serial No. (IJKL) :

Manufacturing sequence of product, for example : 0001~9999.

18. Incoming Inspection Standards

18.1 The environmental condition of inspection

The environmental condition and visual inspection shall be conducted as below.

- (1) Ambient temperature $25 \pm 5^{\circ}\text{C}$
- (2) Humidity: 45 ~ 65 % RH
- (3) Viewing distance is approximately 30 ~ 40 cm
- (4) Viewing angle is normal to the LCD panel as Fig_1 ($\pm 45^{\circ}$)
- (5) Ambient Illumination: 300 ~ 500 Lux for external appearance inspection

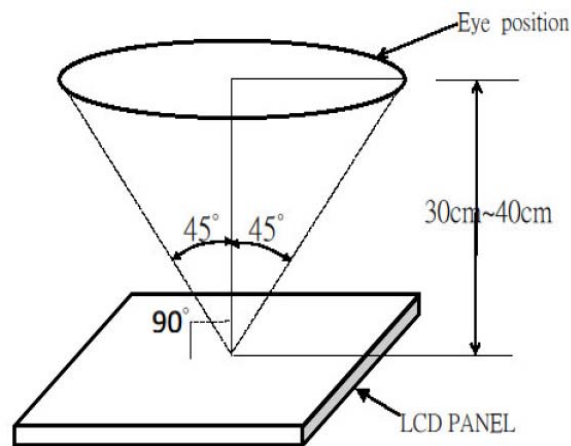

Fig_1

18.2 The defects classify of AQL as following:

- (1) Test method :According to ANSI/ASQC Z 1.4 .General Inspection Level II take a single time
- (2) The defects classify of AQL as following:

Class of defects	AQL	Definition
Major	0.65%	It is defect that is likely to result in failure or to reduce materially the usability of the intended function.
Minor	1.5%	It is a defect that will not result in functioning problem with deviation classified.

18.3 Inspection Parameters

Item		Specification/Description			Note	
Display	Function	No Display			-	
		Malfunction			-	
Operating	Contrast ratio	Out of Spec			-	
	Line defect	No obvious Vertical and Horizontal line defect in bright , dark and colored.			-	
	Point Defect (red ,green ,blue ,dark ,white)	Item	Acceptable number		Note: 1、4 5、6	
			A	B		Total
		BRIGHT DOT	$N \leq 2$	$N \leq 2$		$N \leq 7$
		DARK DOT	$N \leq 3$	$N \leq 4$		
		TOTAL DOT	$N \leq 4$	$N \leq 5$		
TWO ADJACENT DOT	NOT ALLOWED					
THREE OR MORE ADJACENT DOT	NOT ALLOWED					
External Inspection (non-operating or operating)	Scratch (in display area)	L(mm)	W(mm)	Acceptable number	Note:2	
		$L \leq 2.5$	$W \leq 0.1$	4		
		$L > 2.5$	$W > 0.1$	0		
	Polarizer dent or bubble (in display area)	Dimension(mm)		Acceptable number	Note:3	
		$D \leq 0.25$		Disregard		
		$D \leq 0.5$		4		
	Line Shape (Particles and Lint in display area)	L(mm)	W(mm)	Acceptable number	Note:2	
		-	$W \leq 0.07$	Disregard		
		$L \leq 5$	$W \leq 0.1$	4		
		$L \geq 5$	$W \geq 0.1$	0		
	Dot Shape (Particle in Display area)	Dimension(mm)		Acceptable number	Note:3	
		$D \leq 0.25$		Disregard		
		$D \leq 0.5$		4		

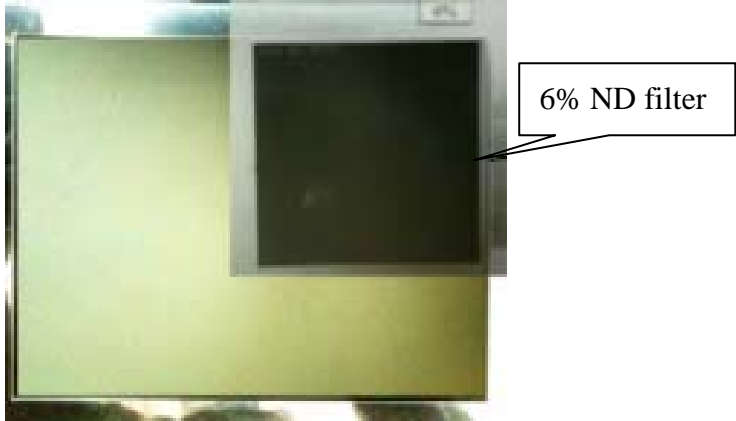
Item	Specification/Description	Note
<p>External Inspection (non-operating or operating)</p>	<p>Has the non-uniform phenomenon</p> 	
	<p>Weak defect will be defined as mura if it can be observed through ND filter 6%</p> 	

Incoming Inspection Touch Panel

Circular Defects
 Linear Defects
 Scratch
 Air Bubble
 Crack

(1) Circular Defects

$$\phi = (L+W)/2$$

Diameter(mm)	Spec
$\phi \leq 0.2$	No quantity limit
$0.2 < \phi \leq 0.4$	Max 5 defect
$0.5 \leq \phi$	Reject

(2) Linear Defects

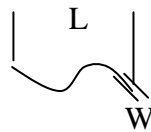

Length	Width	Acceptable
$8.0 \geq L$	$0.06 \geq W$	Accept
$8.0 \geq L$	$0.08 \geq W$	Max 5 defect
$L > 8.0$	$W > 0.08$	Reject

The Min distance of defects must be above 15.0mm.

(3) Scratch

Length	Width	Acceptable
$8.0 \geq L$	$0.06 \geq W$	Accept
$8.0 \geq L$	$0.08 \geq W$	Max 5 defect
$L > 12.0$	$W > 0.08$	Reject

The Min distance of defects must be above 15.0mm.

(4) Air Bubble

Diameter(mm)	Spec
$\phi \leq 0.2$	No quantity limit
$0.2 < \phi \leq 0.6$	Max 3 defect

The Min distance of defects must be above 10.0mm.

(5) Crack

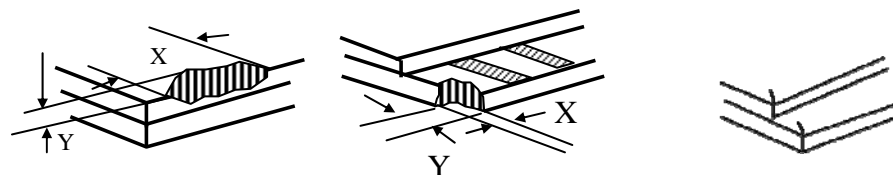

$Z \leq T, X \leq 1/8$ Sensor wide

$X \leq 3mm$ and $Y \leq 1/3D$

Y: Did not enter the VA

(Accept)

(Accept)

(Reject)

Y:
Long breakage

Z:
Wide breakage

D:
thickness
breakage

T:
single piece of
glass thickness
(Touch sensor
single thickness)

VA:
Touch control
panel viewing
area.

Sensor wide:
the size of the
long side of the
touch panel.

Note1. The definition of dot defect : The dot defect was judged after repair and the size of a defective dot over 1/2 of whole dot is regarded as one defective dot.

Note2.

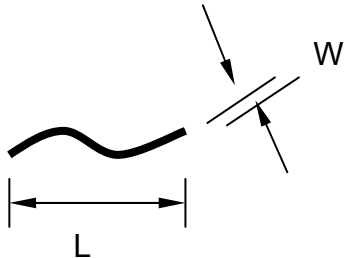

Note3. D : Diameter $D=(a+b)/2$

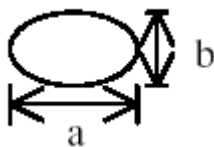

Note4. Bright dot is defined through 6% transmission ND Filter as following.

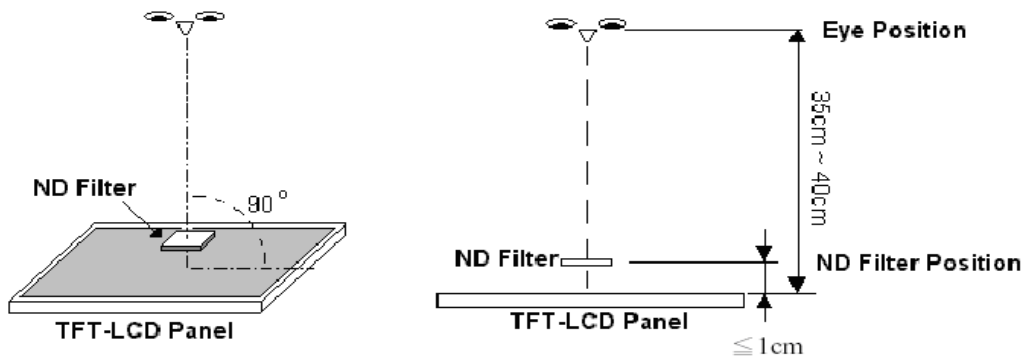

Note5. ADJACENT DOT



EVERVISION	MODEL NO.		PAGE
	VGG644810-6UFLWB	SPEC SAMPLE	40

Note6.

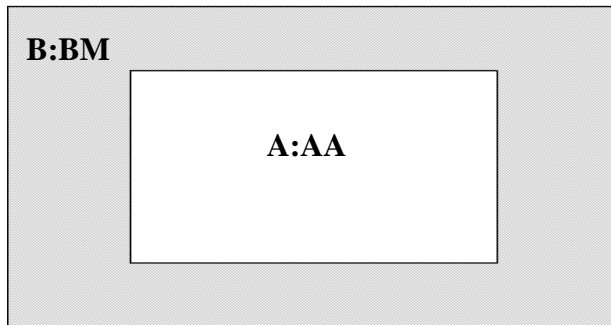

18.4 Handling of LCM

- (1) Don't give external shock.
- (2) Don't apply excessive force on the surface.
- (3) Liquid in LCD is hazardous substance. Must not lick and swallow. when the liquid is attach to your hand, skin, cloth etc. Wash it out thoroughly and immediately.
- (4) Don't operate it above the absolute maximum rating.
- (5) Don't disassemble the LCM.